

LORD QUICK START GUIDE

V-Link[®]-200[®]

Wireless 8 Channel Analog Input Sensor Node

The V-Link-200 wireless sensor node features eight analog input channels designed to accommodate a wide range of Wheatstone bridge and analog sensors, including strain, load cell, torque, pressure, acceleration, vibration, magnetic field, displacement, and geophones. There are four channels for single-ended sensor measurement, four channels for differential sensor measurement, and an on-board internal temperature sensor.

To acquire sensor data, the V-Link-200 is used with a LORD Sensing data gateway such as the WSDA-101 or WSDA-1500 Base. V-Link-200 sensor nodes come with the following components.

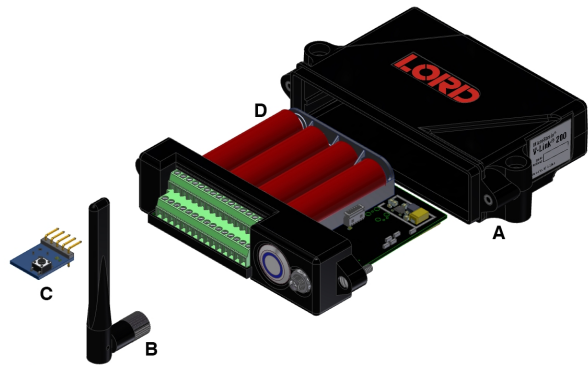

Item	Description	Quantity
A	V-Link-200 Wireless Sensor Node	1
B	Antenna with right angle adapter	1
C	Node Tester Board	1
D	AA Lithium Batteries (3.6 V dc, 2.4 Ah)	4

Table 1 - V-Link-200 Components List

The LED indicators on the V-Link-200 include operational modes showing when the node is booting up, idle and waiting for a command, sampling, resynchronizing, or if there is an error. [see Table 2 - below](#) describing basic indicator behavior.

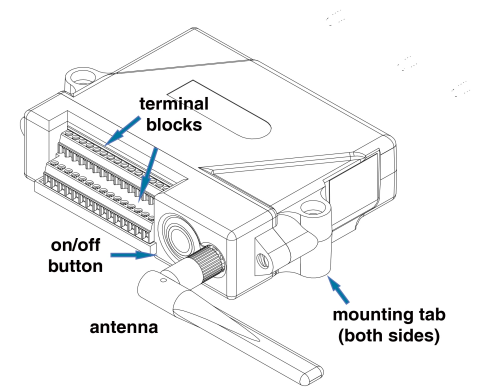

Figure 1 - Interface and Indicators

Indicator	Behavior	Node Status
Device status indicator	OFF	Node is OFF
	Rapid green flashing on start-up	Node is booting up
	1 (slow) green pulse per second	Node is idle and waiting for a command
	1 green blink every 2 seconds	Node is sampling
	Blue LED during sampling	Node is resynchronizing
	Red LED	Error or low battery

Table 2 - Indicator Behaviors

SYSTEM OPERATION

Sensor nodes have three operational modes: *active*, *sleep*, and *idle*. When the node is sampling, it is in active mode. When sampling stops, the node is switched into idle mode, which is used for configuring node settings, and allows toggling between sampling and sleeping modes. The node will automatically go into the ultra low-power sleep mode after a user-determined period of inactivity. The node will not go into sleep mode while sampling.

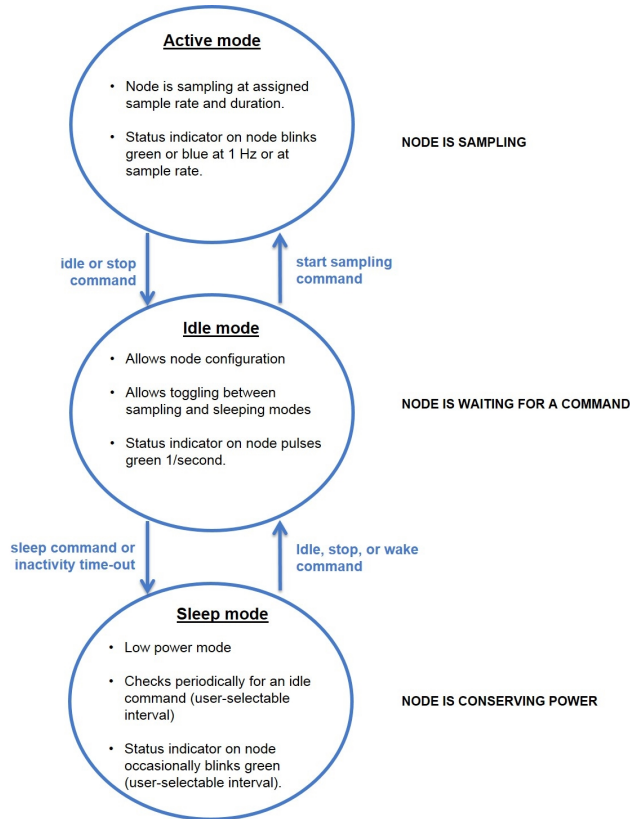

Figure 2 - Node Operational Modes

1. Install Software

Install the SensorConnect software on the host computer before connecting any hardware. The SensorConnect software is available on the LORD Sensing website for free download:

<http://www.microstrain.com/software/software>

2. Make System Connections

To acquire sensor data, the V-Link-200 is used with a LORD Sensing data gateway such as the WSDA-101-Base or WSDA-1500-LXRS.

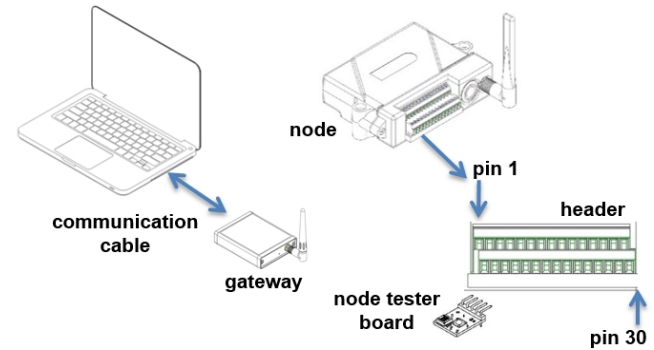

Node Pin Number	Signal	Node Pin Number	Signal
1	SP+	16	SP+
2	S1+	17	S4+
3	S1-	18	S4-
4	GND	19	GND
5	S1 S	20	S4 S
6	SP+	21	Ain5
7	S2+	22	GND
8	S2-	23	Ain6
9	GND	24	GND
10	S2 S	25	Ain7
11	SP+	26	GND
12	S3+	27	NC
13	S3-	28	NC
14	GND	29	Vin
15	S3 S	30	GND

terminal block connections

3. Establish Gateway Communication

The WSDA-101-Base USB gateway is used in this example. For information on how to use other gateways, refer to the gateway or SensorConnect user manual.

Drivers for the USB gateways are included in the SensorConnect software installation. With the software installed, the USB gateway will be detected automatically whenever the gateway is plugged in.

1. Power is applied to the gateway through the USB connection. Verify the gateway status indicator is illuminated, showing the gateway is connected and powered on.

2. Open the SensorConnect software.



3. The gateway should appear in the Controller window automatically with a communication port assignment. If the gateway is not automatically discovered, verify the port is active on the host computer, and then remove and re-insert the USB connector.

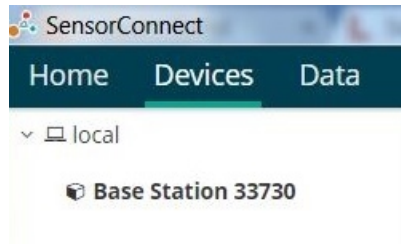

Figure 3 - USB Gateway Communication

4. Connect to Nodes

The node can be connected with the automatic node discovery feature and by manually entering the node address and then searching for it on the current gateway communication frequency.

1. If the base and node are on the same operating frequency, the node will populate below the Base Station listing when powering on the V-Link-200.

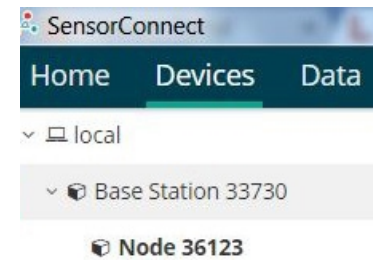

Figure 4 - Automatic Node Discovery

2. If a red circle with a number appears next to Base Station, the node is operating on a separate radio channel. Select the Base Station and then select the Nodes on Other Frequencies tile.

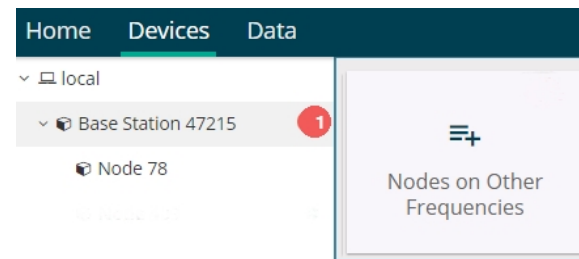

Figure 5 - Nodes On Other Frequencies

- Highlight the new node being added. Select Move Node to Frequency (#).

Node	Frequency	Last Heard
56210	24	2 minutes 8 seconds ago
200	24	4 minutes 49 seconds ago
48879	20	14 minutes 50 seconds ago

Move Node to Frequency 15

Figure 6 - Move Node

- When manually entering the node address, select Manual Add Node, enter Node Address, last known Frequency (factory default is 15), and select Add Node.

Manual Add Node

Node Address

Frequency

Add Node

Figure 7 - Adding a Node by Address

5. Configure Node

Node settings are stored to non-volatile memory and may be configured using SensorConnect. For details related to node configuration, see [Wireless Sensor Configuration on page 1](#).

For this example the V-Link-200 tester board is on channel 1.

- Select Hardware > Input Range for channel 1, select +/-2 mV from the drop down menu.
- Under Hardware Offset, select Balance Target for channel 1, select Mid (50%) from the drop down menu.
- Select Auto-Balance. When auto-balance is complete, a blue information window will indicate the balance result.

Hardware Calibration Sampling

Input Range

Channel(s) Input Range

1 +/-2 millivolts

Hardware Offset

Channel(s) Offset Balance Target

1 640 Mid (50%) **Auto Balance**

Auto balance complete
(achieved: 49.99%)

Figure 8 - Auto-Balance

- Select Calibration.
- Select Microstrain from the Unit drop down menu, and select the Shunt Cal button enabled on the right.

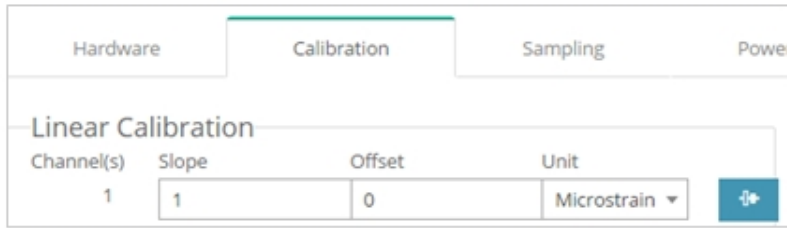

Figure 9 - Node Configuration Menu

6. Use the following settings:
 - a. **Calibration Mode:** Internal
 - b. **Number of Active Gauges:** 4
 - c. **Gauge Factor:** 2
 - d. **Gauge Resistance:** 1000
 - e. **Shunt Resistance:** 499000
7. Select Start Shunt Cal for Slope and Offset calibrations.
8. Select Accept Calibration.

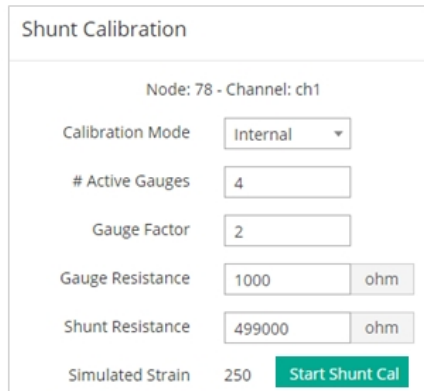

Figure 10 - Channel Settings

9. When the calibration is complete, the Wireless Node Configuration window will appear.
10. Select Apply Configuration to write to node memory.

See below for wiring of other strain gauges.

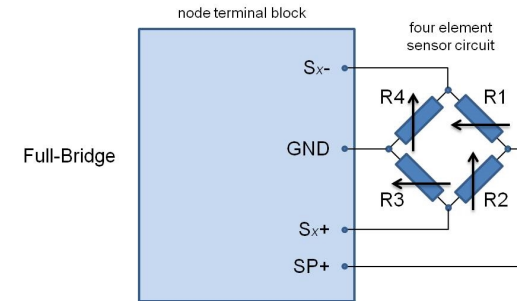

Figure 11 - Full-Bridge (Standard)

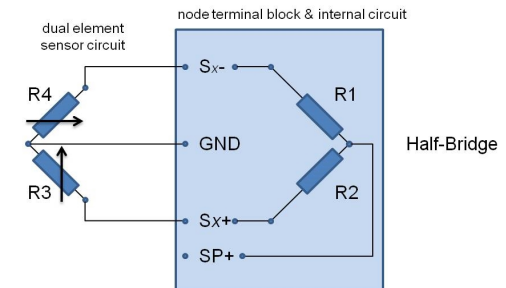

Figure 12 - Half-Bridge

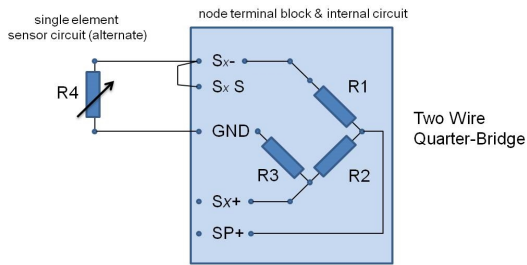

Figure 13 - Two Wire Quarter-Bridge *

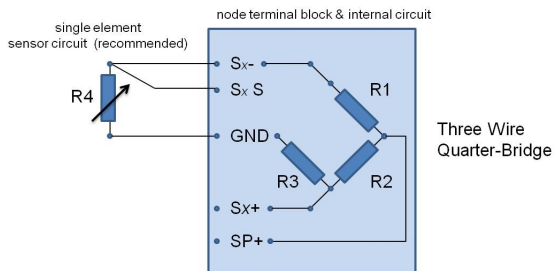

Figure 14 - Three Wire Quarter-Bridge *

* Requires optional on-board bridge completion

6. Configure Sampling Setting and Start Data Acquisition

1. Left click on the Base Station > Sampling, and indicate the nodes to be sampled by checking the box to the left of each node.
2. Under Sampling, select Sample Rate from the drop down menu, select Continuously to sample indefinitely, or For to set a limited time for sample sets.



Figure 15 - Sampling Setting

3. Select Apply and Start Network.
4. Select Create Quick View Dashboard in the pop up window immediately to create a dashboard of the new data.

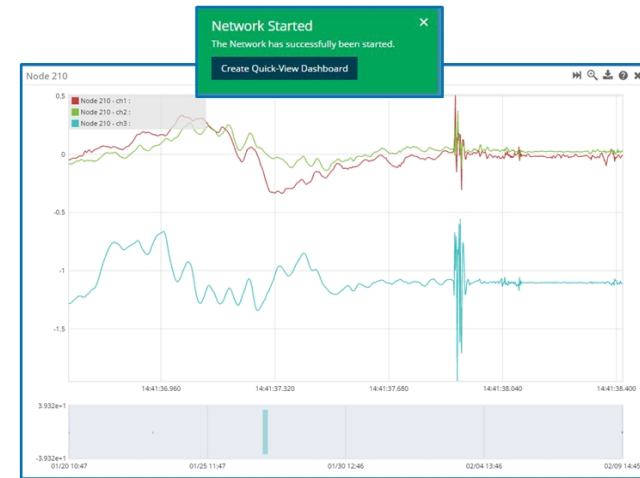

Figure 16 - Quick View Dashboard

7. Replacing Batteries

1. Remove the screws on both sides of the face plate to open the V-Link-200.
2. **It is important to replace all four of the batteries at the same time**, observing the correct polarity orientation. The positive polarities are indicated on the batteries and the node by a "+" symbol.
3. Reassemble.

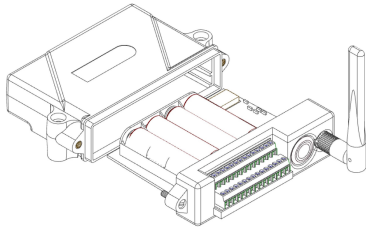

Figure 17 - Replace Batteries

8. Battery Hazards

WARNING

CAUTION

NOTICE



The V-Link-200 contains internal, non-rechargeable lithium batteries. Lithium batteries are a fire and explosion hazard. Do not store or operate the node at temperatures above 212°F (100°C). Do not disassemble, short circuit, crush, puncture, or otherwise misuse the battery.



Lithium batteries contain toxic chemicals that are harmful to humans and the environment. Disposal is subject to federal and local laws. Do not discard the battery or the node in the trash. Follow proper battery disposal protocol, or contact LORD Sensing Technical Support for information on extracting the battery or returning the product for proper recycling and disposal.

9. Regulatory Compliance Information

FCC ID: XJQMSLINK0004

IC ID: 8505A-MSLINK0005

V-Link-200 Wireless 8 Channel Analog Input Sensor Node

This device complies with Part 15 of the United States FCC Rules, and Industry Canada's license-exempt RSSs. Operation is subject to the following two conditions: 1) This device may not cause interference, and 2) This device must accept any interference, including interference that may cause undesired operation of the device. Changes or modifications, including antenna changes not expressly approved by LORD Corporation could void the user's authority to operate the equipment.

Cet appareil est conforme à la Partie 15 des Règles de la FCC des États-Unis et aux RSSS exempts de licence d'Industrie Canada. Le fonctionnement est soumis aux deux conditions suivantes: 1) Cet appareil ne doit pas causer d'interférences et 2) Cet appareil doit accepter toute interférence, y compris les interférences pouvant entraîner un fonctionnement indésirable de l'appareil. Les changements ou modifications, y compris les changements d'antenne non expressément approuvés par LORD Corporation, pourraient annuler l'autorisation de l'utilisateur d'utiliser l'équipement.

10. Power Supply

The V-Link-200 Wireless Sensor Node can be powered by an external source.



Apply only the input voltage range specified for the V-Link-200. Connect to a power source that is near the device, is accessible, and adheres to all national wiring standards. Compliance with wiring standards is assumed in the installation of the power source and includes protection against excessive currents, short circuits, and ground faults. Failure to do so could result in personal injury and permanent damage to the device.