

## 3DM<sup>®</sup>-GX5-45

GNSS-Aided Inertial Navigation System (GNSS/INS)

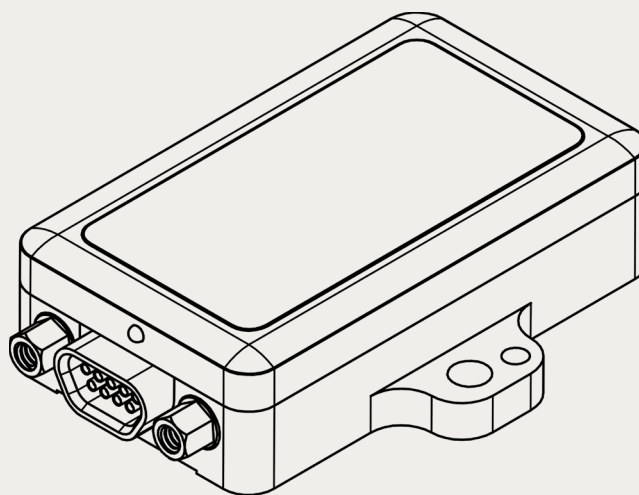



MicroStrain® Sensing Systems  
459 Hurricane Lane  
Suite 102  
Williston, VT 05495  
United States of America

**Phone:** 802-862-6629

[www.microstrain.com](http://www.microstrain.com)  
[sensing\\_support@LORD.com](mailto:sensing_support@LORD.com)  
[sensing\\_sales@LORD.com](mailto:sensing_sales@LORD.com)

Copyright © 2018 LORD Corporation

3DM®, 3DM-DH®, 3DM-DH3®, 3DM-GX2®, Ask Us How™, DEMOD-DC®, DVRT®, EmbedSense®, FAS-A®, G-Link®, Little Sensors, Big Ideas.®, LORD Microstrain®, Live Connect™, LXRS®, MathEngine®, MicroStrain®, MIP™, MXRS®, Node Commander®, SensorCloud™, SensorConnect™, SG-Link®, Strain Wizard®, TC-Link®, V-Link®, Wireless Simplicity, Hardwired Reliability™, and WSDA® are trademarks of LORD Corporation.

Document 8500-0064 Rev-M

Subject to change without notice.

|  |    |
|--|----|
| 1. API Introduction .....                            | 1  |
| 2. Basic Programming .....                           | 2  |
| 2.1 MIP Packet Overview .....                        | 2  |
| 2.2 Command Overview .....                           | 4  |
| 2.2.1 Example “Ping” Command Packet .....            | 4  |
| 2.2.2 Example “Ping” Reply Packet .....              | 5  |
| 2.3 Data Overview .....                              | 6  |
| 2.3.1 Example Data Packet: .....                     | 6  |
| 2.4 Example Setup Sequence .....                     | 7  |
| 2.4.1 Continuous Data Example Command Sequence ..... | 7  |
| 2.4.2 Polling Data Example Sequence .....            | 14 |
| 2.5 Parsing Incoming Packets .....                   | 16 |
| 2.6 Multiple Rate Data .....                         | 17 |
| 2.7 Data Synchronicity .....                         | 18 |
| 2.8 Communications Bandwidth Management .....        | 18 |
| 2.8.1 UART Bandwidth Calculation .....               | 19 |
| 2.8.2 USB vs. UART .....                             | 20 |
| 3 Command and Data Summary .....                     | 21 |
| 3.1 Commands .....                                   | 21 |
| 3.1.1 Base Command Set (0x01) .....                  | 21 |
| 3.1.2 3DM Command Set (0x0C) .....                   | 21 |
| 3.1.3 Estimation Filter Command Set (0x0D) .....     | 22 |
| 3.1.4 System Command Set (0x7F) .....                | 23 |
| 3.2 Data .....                                       | 23 |
| 3.2.1 IMU Data Set (0x80) .....                      | 23 |
| 3.2.2 GNSS Data Set (0x81) .....                     | 23 |
| 3.2.3 Estimation Filter Data Set (0x82) .....        | 24 |
| 4. Command Reference .....                           | 25 |
| 4.1 Base Commands .....                              | 25 |
| 4.1.1 Ping (0x01, 0x01) .....                        | 25 |
| 4.1.2 Set To Idle (0x01, 0x02) .....                 | 26 |
| 4.1.3 Get Device Information (0x01, 0x03) .....      | 27 |
| 4.1.4 Get Device Descriptor Sets (0x01, 0x04) .....  | 28 |
| 4.1.5 Device Built-In Test (0x01, 0x05) .....        | 29 |
| 4.1.6 Resume (0x01, 0x06) .....                      | 31 |

|  |    |
|--|----|
| 4.1.7 Get Extended Device Descriptor Sets (0x01, 0x07) .....   | 31 |
| 4.1.8 GPS Time Update (0x01, 0x72).....                        | 32 |
| 4.1.9 Device Reset (0x01, 0x7E) .....                          | 34 |
| 4.2 3DM Commands.....  | 35 |
| 4.2.1 Poll IMU Data (0x0C, 0x01).....                          | 35 |
| 4.2.2 Poll GNSS Data (0x0C, 0x02) .....                        | 36 |
| 4.2.3 Poll Estimation Filter Data (0x0C, 0x03) .....           | 38 |
| 4.2.4 Get IMU Data Base Rate (0x0C, 0x06) .....                | 39 |
| 4.2.5 Get GNSS Data Base Rate (0x0C, 0x07).....                | 40 |
| 4.2.6 Get Estimation Filter Data Base Rate (0x0C, 0x0B).....   | 41 |
| 4.2.7 IMU Message Format (0x0C, 0x08).....                     | 42 |
| 4.2.8 GNSS Message Format (0x0C, 0x09) .....                   | 44 |
| 4.2.9 Estimation Filter Message Format (0x0C, 0x0A) .....      | 46 |
| 4.2.10 Enable/Disable Continuous Data Stream (0x0C, 0x11)..... | 48 |
| 4.2.11 GNSS Constellation Settings (0x0C, 0x21) .....          | 50 |
| 4.2.12 GNSS SBAS Settings (0x0C, 0x22).....                    | 53 |
| 4.2.13 GNSS Assisted Fix Control (0x0C, 0x23) .....            | 55 |
| 4.2.14 GNSS Assist Time Update (0x0C, 0x24) .....              | 56 |
| 4.2.15 Device Startup Settings (0x0C, 0x30).....               | 58 |
| 4.2.16 Accel Bias (0x0C, 0x37).....                            | 59 |
| 4.2.17 Gyro Bias (0x0C, 0x38).....                             | 60 |
| 4.2.18 Capture Gyro Bias (0x0C, 0x39).....                     | 61 |
| 4.2.19 Magnetometer Hard Iron Offset (0x0C, 0x3A) .....        | 62 |
| 4.2.20 Magnetometer Soft Iron Matrix (0x0C, 0x3B) .....        | 63 |
| 4.2.21 Coning and Sculling Enable (0x0C, 0x3E).....            | 65 |
| 4.2.22 UART Baud Rate (0x0C, 0x40).....                        | 66 |
| 4.2.23 Advanced Low-Pass Filter Settings (0x0C, 0x50) .....    | 67 |
| 4.2.24 Complementary Filter Settings (0x0C, 0x51).....         | 69 |
| 4.2.25 Device Status (0x0C, 0x64) .....                        | 70 |
| 4.2.26 Raw RTCM 2.3 Message (0x0C, 0x20) .....                 | 73 |
| 4.3 Estimation Filter Commands.....                            | 74 |
| 4.3.1 Reset Filter (0x0D, 0x01) .....                          | 74 |
| 4.3.2 Set Initial Attitude (0x0D, 0x02) .....                  | 75 |
| 4.3.3 Set Initial Heading (0x0D, 0x03) .....                   | 76 |
| 4.3.4 Vehicle Dynamics Mode (0x0D, 0x10).....                  | 77 |

|   |     |
|---|-----|
| 4.3.5 Sensor to Vehicle Frame Rotation (0x0D, 0x11) .....                   | 79  |
| 4.3.6 Sensor to Vehicle Frame Offset (0x0D, 0x12) .....                     | 81  |
| 4.3.7 Antenna Offset (0x0D, 0x13) .....                                     | 83  |
| 4.3.8 Estimation Control Flags (0x0D, 0x14) .....                           | 84  |
| 4.3.9 GNSS Source Control (0x0D, 0x15) .....                                | 85  |
| 4.3.10 External GNSS Update (0x0D, 0x16) .....                              | 86  |
| 4.3.11 Heading Update Control (0x0D, 0x18).....                             | 87  |
| 4.3.12 External Heading Update (0x0D, 0x17) .....                           | 89  |
| 4.3.13 External Heading Update with Timestamp (0x0D, 0x1F).....             | 90  |
| 4.3.14 Pitch/Roll Aiding Control (0x0D, 0x4B) .....                         | 91  |
| 4.3.15 Altitude Aiding Control (0x0D, 0x47).....                            | 92  |
| 4.3.16 Auto-Initialization Control (0x0D, 0x19) .....                       | 93  |
| 4.3.17 Magnetometer Noise Standard Deviation (0x0D, 0x42) .....             | 94  |
| 4.3.18 Gravity Noise Standard Deviation (0x0D, 0x28) .....                  | 95  |
| 4.3.19 Pressure Altitude Noise Standard Deviation (0x0D, 0x29).....         | 96  |
| 4.3.20 Accelerometer Noise Standard Deviation (0x0D, 0x1A).....             | 96  |
| 4.3.21 Accelerometer Bias Model Parameters (0x0D, 0x1C) .....               | 98  |
| 4.3.22 Gyroscope Noise Standard Deviation (0x0D, 0x1B).....                 | 99  |
| 4.3.23 Gyroscope Bias Model Parameters (0x0D, 0x1D).....                    | 101 |
| 4.3.24 Hard Iron Offset Process Noise (0x0D, 0x2B) .....                    | 102 |
| 4.3.25 Soft Iron Matrix Process Noise (0x0D, 0x2C) .....                    | 103 |
| 4.3.26 Zero Velocity Update (ZUPT) Control (0x0D, 0x1E).....                | 104 |
| 4.3.27 Zero Angular Rate Update Control (0x0D, 0x20).....                   | 105 |
| 4.3.28 Tare Orientation (0x0D, 0x21) .....                                  | 106 |
| 4.3.29 Commanded Zero-Velocity Update (0x0D, 0x22).....                     | 107 |
| 4.3.30 Commanded Zero-Angular Rate Update (0x0D, 0x23) .....                | 108 |
| 4.3.31 Declination Source (0x0D, 0x43) .....                                | 109 |
| 4.3.32 Inclination Source (0x0D, 0x4C) .....                                | 110 |
| 4.3.33 Magnetic Field Magnitude Source (0x0D, 0x4D) .....                   | 111 |
| 4.3.34 Gravity Magnitude Error Adaptive Measurement (0x0D, 0x44).....       | 113 |
| 4.3.35 Magnetometer Magnitude Error Adaptive Measurement (0x0D, 0x45) ..... | 115 |
| 4.3.36 Magnetometer Dip Angle Error Adaptive Measurement (0x0D, 0x46) ..... | 117 |
| 4.3.37 Magnetometer Capture Auto Calibration (0x0D, 0x27).....              | 119 |
| 4.4 System Commands .....   | 120 |
| 4.5 Error Codes .....   | 121 |

|  |     |
|--|-----|
| 5 Data Reference.....                                | 122 |
| 5.1 IMU Data.....                                    | 122 |
| 5.1.1 Scaled Accelerometer Vector (0x80, 0x04) ..... | 122 |
| 5.1.2 Scaled Gyro Vector (0x80, 0x05).....           | 123 |
| 5.1.3 Scaled Magnetometer Vector (0x80, 0x06) .....  | 123 |
| 5.1.4 Scaled Ambient Pressure (0x80, 0x17) .....     | 124 |
| 5.1.5 Delta Theta Vector (0x80, 0x07) .....          | 124 |
| 5.1.6 Delta Velocity Vector (0x80, 0x08).....        | 125 |
| 5.1.7 CF Orientation Matrix (0x80, 0x09).....        | 125 |
| 5.1.8 CF Quaternion (0x80, 0x0A) .....               | 127 |
| 5.1.9 CF Euler Angles (0x80, 0x0C) .....             | 128 |
| 5.1.10 CF Stabilized North Vector (0x80, 0x10) ..... | 129 |
| 5.1.11 CF Stabilized Up Vector (0x80, 0x11).....     | 130 |
| 5.1.12 GPS Correlation Timestamp (0x80, 0x12).....   | 130 |
| 5.2 GNSS Data .....                                  | 133 |
| 5.2.1 LLH Position (0x81, 0x03).....                 | 133 |
| 5.2.2 ECEF Position (0x81, 0x04).....                | 134 |
| 5.2.3 NED Velocity (0x81, 0x05).....                 | 135 |
| 5.2.4 ECEF Velocity (0x81, 0x06).....                | 136 |
| 5.2.5 DOP Data (0x81, 0x07).....                     | 137 |
| 5.2.6 UTC Time (0x81, 0x08).....                     | 138 |
| 5.2.7 GPS Time (0x81, 0x09) .....                    | 139 |
| 5.2.8 Clock Information (0x81, 0x0A).....            | 139 |
| 5.2.9 GNSS Fix Information (0x81, 0x0B).....         | 140 |
| 5.2.10 Space Vehicle Information (0x81, 0x0C) .....  | 141 |
| 5.2.11 Hardware Status (0x81, 0x0D).....             | 142 |
| 5.2.12 DGNSS Information (0x81, 0x0E).....           | 143 |
| 5.2.13 DGNSS Channel Status (0x81, 0x0F) .....       | 144 |
| 5.3 Estimation Filter Data .....                     | 145 |
| 5.3.1 Filter Status (0x82, 0x10).....                | 145 |
| 5.3.2 GPS Timestamp (0x82, 0x11).....                | 147 |
| 5.3.3 LLH Position (0x82, 0x01).....                 | 148 |
| 5.3.4 LLH Position Uncertainty (0x82, 0x08) .....    | 149 |
| 5.3.5 NED Velocity (0x82, 0x02).....                 | 149 |
| 5.3.6 NED Velocity Uncertainty (0x82, 0x09) .....    | 150 |

|   |     |
|---|-----|
| 5.3.7 Orientation, Quaternion (0x82, 0x03) .....                    | 151 |
| 5.3.8 Attitude Uncertainty, Quaternion Elements (0x82, 0x12).....   | 152 |
| 5.3.9 Orientation, Euler Angles (0x82, 0x05).....                   | 153 |
| 5.3.10 Attitude Uncertainty, Euler Angles (0x82, 0x0A).....         | 154 |
| 5.3.11 Orientation, Matrix (0x82, 0x04).....                        | 155 |
| 5.3.12 Compensated Angular Rate (0x82, 0x0E) .....                  | 156 |
| 5.3.13 Gyro Bias (0x82, 0x06) .....                                 | 157 |
| 5.3.14 Gyro Bias Uncertainty (0x82, 0x0B).....                      | 157 |
| 5.3.15 Gyro Scale Factor (0x82, 0x16) .....                         | 158 |
| 5.3.16 Gyro Scale Factor Uncertainty (0x82, 0x18).....              | 158 |
| 5.3.17 Compensated Acceleration (0x82, 0x1C) .....                  | 159 |
| 5.3.18 Linear Acceleration (0x82, 0x0D) .....                       | 160 |
| 5.3.19 Accel Bias (0x82, 0x07) .....                                | 161 |
| 5.3.20 Accel Bias Uncertainty (0x82, 0x0C) .....                    | 161 |
| 5.3.21 Accel Scale Factor (0x82, 0x17).....                         | 162 |
| 5.3.22 Accel Scale Factor Uncertainty (0x82, 0x19).....             | 163 |
| 5.3.23 Pressure Altitude (0x82, 0x21).....                          | 164 |
| 5.3.24 Standard Atmosphere Model (0x82, 0x20) .....                 | 165 |
| 5.3.25 Gravity Vector (0x82, 0x13) .....                            | 166 |
| 5.3.26 WGS84 Local Gravity Magnitude (0x82, 0x0F) .....             | 167 |
| 5.3.27 Heading Update Source State (0x82, 0x14) .....               | 168 |
| 5.3.28 Magnetic Model Solution (0x82, 0x15) .....                   | 169 |
| 5.3.29 Mag Auto Hard Iron Offset (0x82, 0x25) .....                 | 170 |
| 5.3.30 Mag Auto Hard Iron Offset Uncertainty (0x82, 0x28).....      | 170 |
| 5.3.31 Mag Auto Soft Iron Matrix (0x82, 0x26) .....                 | 171 |
| 5.3.32 Mag Auto Soft Iron Matrix Uncertainty (0x82, 0x29).....      | 172 |
| 5.3.33 GNSS Antenna Offset Correction (0x82, 0x30).....             | 173 |
| 5.3.34 GNSS Antenna Offset Correction Uncertainty (0x82, 0x31)..... | 174 |
| 6 MIP Packet Reference.....   | 175 |
| 6.1 Structure .....   | 175 |
| 6.2 Payload Length Range .....                                      | 175 |
| 6.3 MIP Checksum Range .....  | 175 |
| 6.4 16-bit Fletcher Checksum Algorithm (C Language).....            | 175 |
| 7 Advanced Programming.....   | 176 |
| 7.1 Multiple Commands in a Single Packet.....                       | 176 |

|   |     |
|---|-----|
| 7.2 Direct Modes .....                              | 177 |
| 7.3 Internal Diagnostic Functions.....              | 177 |
| 7.3.1 3DM-GX5-45 Internal Diagnostic Commands ..... | 177 |
| 7.4 Handling High Rate Data .....                   | 178 |
| 7.4.1 Runaway Latency .....                         | 178 |
| 7.4.2 Dropped Packets .....                         | 178 |
| 7.5 Creating Fixed Data Packet Format .....         | 179 |
| 7.6 Advanced Programming Models .....               | 180 |
| 8 Glossary.....                                     | 181 |



## 1. API Introduction

The 3DM-GX5-45 programming interface is comprised of a compact set of setup and control commands and a very flexible user-configurable data output format. The commands and data are divided into four command sets and three data sets corresponding to the internal architecture of the device. The four command sets consist of a set of “Base” commands (a set that is common across many types of devices), a set of unified “3DM” (3D Motion) commands that are specific to the LORD Sensing inertial product line, a set of “Estimation Filter” commands that are specific to LORD Sensing navigation and advanced AHRS devices, and a set of “System” commands that are specific to sensor systems comprised of more than one internal sensor block. The data sets represent the three types of data that the 3DM-GX5-45 is capable of producing: “Estimation Filter” (Position, Velocity, and Attitude) data, “GNSS” (Global Navigation Satellite System) data, and “IMU” (Inertial Measurement Unit) data. The type of estimation filter used in the 3DM-GX5-45 is an Auto-Adaptive Extended Kalman Filter (EKF).

|                                   |  |
|-----------------------------------|--|
| <b>Base commands</b>              | Ping, Idle, Resume, Get ID Strings, etc.                   |
| <b>3DM commands</b>               | Poll IMU Data, Estimation Filter Data, etc.                |
| <b>Estimation Filter commands</b> | Reset Filter, Sensor to Vehicle Frame Transformation, etc. |
| <b>System commands</b>            | Switch Communications Mode, etc.                           |
| <b>IMU data</b>                   | Acceleration Vector, Gyro Vector, etc.                     |
| <b>GNSS data</b>                  | GNSS Position, Velocity, Satellite Data, Fix Data, etc.    |
| <b>Estimation Filter data</b>     | Position, Velocity, Attitude, Acceleration Estimates, etc. |

The protocol is packet based. All commands, replies, and data are sent and received as fields in a message packet. Commands are all confirmed with an ack/nack (with a few exceptions). The packets have a descriptor type field based on their contents, so it is easy to identify if a packet contains IMU data, GNSS data, Estimation Filter data, commands, or replies.

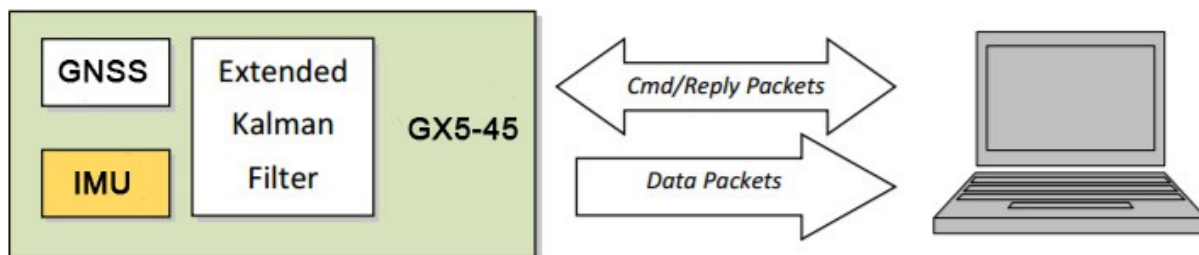

## 2. Basic Programming

The 3DM-GX5-45 is designed to stream Estimation Filter, GNSS, and IMU data packets over a common interface as efficiently as possible. To this end, programming the device consists of a configuration stage where the data messages and data rates are configured. The configuration stage is followed by a data streaming stage where the program starts the incoming data packet stream.

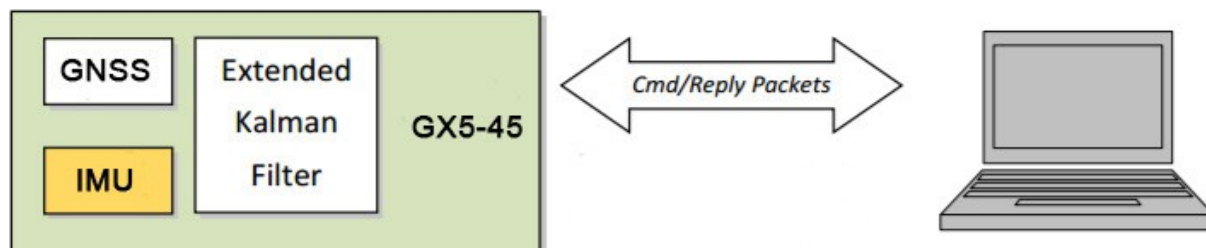

In this section there is an overview of the packet, an overview of command and reply packets, an overview of how an incoming data packet is constructed, and then an example setup command sequence that can be used directly with the 3DM-GX5-45 either through a COM utility or as a template for software development.

### 2.1 MIP Packet Overview

This is an overview of the 3DM-GX5-45 packet structure. The packet structure used is the LORD “MIP” packet. A reference to the general packet structure is presented in the [MIP Packet Reference](#) section. An overview of the packet is presented here.

The MIP packet “wrapper” consists of a four byte header and two byte checksum footer:

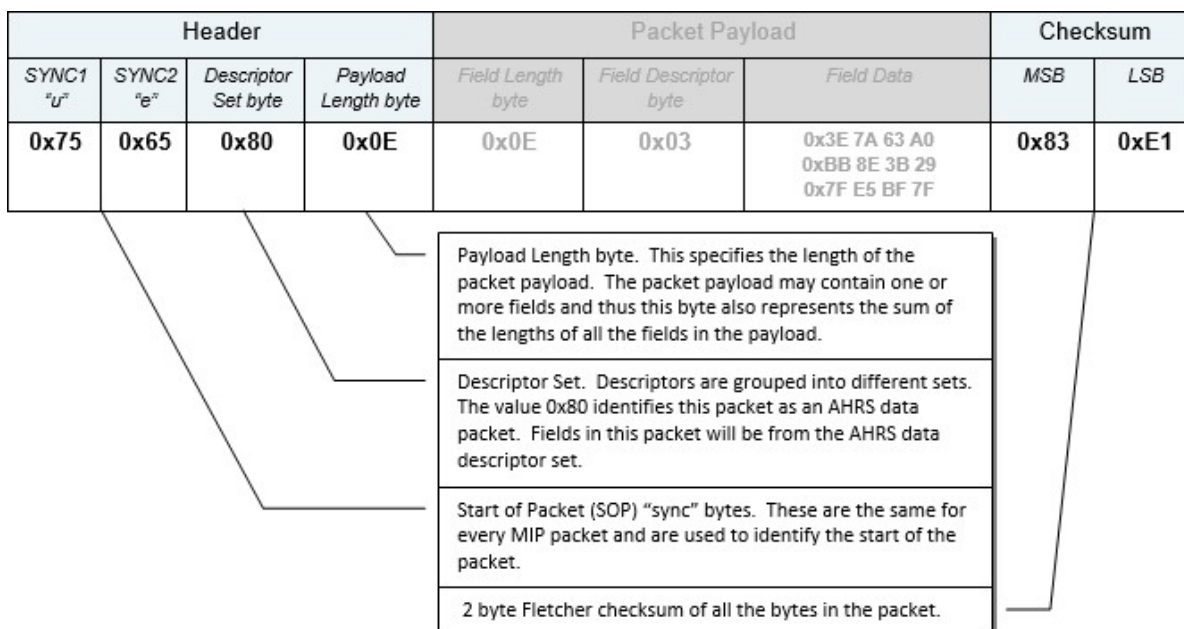

The packet payload section contains one or more fields. Fields have a length byte, descriptor byte, and data. The diagram below shows a packet payload with a single field.

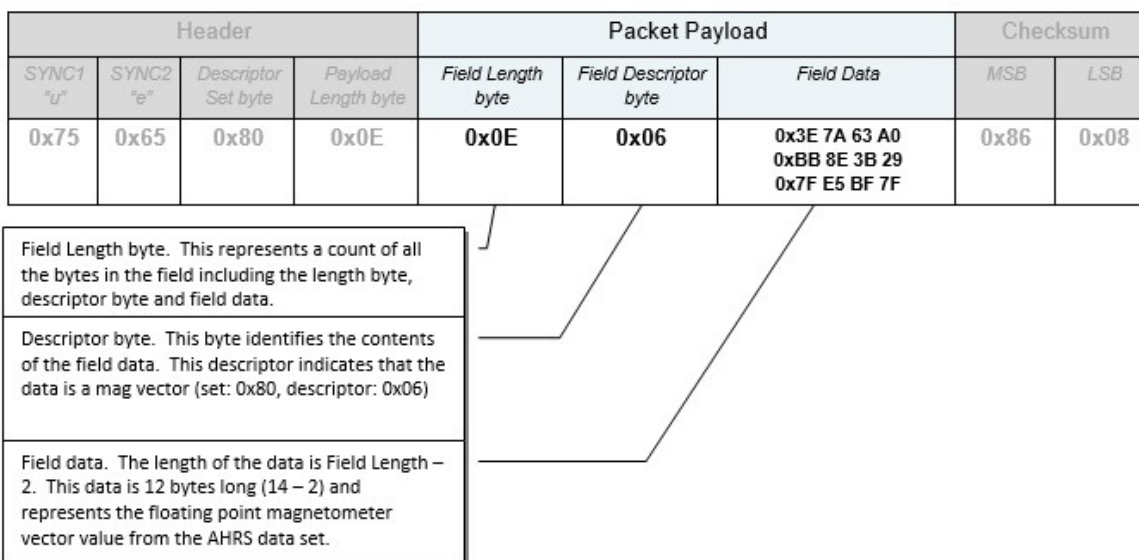

Below is an example of a packet payload with two fields (gyro vector and mag vector). Note the payload length byte of **0x1C** which is the sum of the two field length bytes **0x0E** + **0x0E**:

| Header              |                     |                                      |  | Packet Payload (2 Fields)       |                                     |   |                                 |                                     |   | Checksum   |            |
|---------------------|---------------------|--------------------------------------|--|---------------------------------|-------------------------------------|---|---------------------------------|-------------------------------------|---|------------|------------|
| <i>SYNC1</i><br>"u" | <i>SYNC2</i><br>"e" | <i>Descriptor</i><br><i>Set byte</i> | <i>Payload</i><br><i>Length</i><br><i>byte</i> | <i>Field 1</i><br><i>Length</i> | <i>Field 1</i><br><i>Descriptor</i> | <i>Field 1</i><br><i>Data</i>                   | <i>Field 2</i><br><i>Length</i> | <i>Field 2</i><br><i>Descriptor</i> | <i>Field 2</i><br><i>Data</i>                   | <i>MSB</i> | <i>LSB</i> |
| 0x75                | 0x65                | 0x80                                 | <b>0x1C</b>                                    | <b>0x0E</b>                     | <b>0x05</b>                         | 0x3E 7A 63 A0<br>0xBB 8E 3B 29<br>0x7F E5 BF 7F | <b>0x0E</b>                     | <b>0x06</b>                         | 0x3E 7A 63 A0<br>0xBB 8E 3B 29<br>0x7F E5 BF 7F | 0xE0       | 0xC6       |

## 2.2 Command Overview

The basic command sequence begins with the host sending a command to the device. A command packet contains a field with the command value and any command arguments.

The device responds by sending a reply packet. The reply contains at minimum an ACK/NACK field. If any additional data is included in a reply, it appears as a second field in the packet.

### 2.2.1 Example "Ping" Command Packet

Below is an example of a "Ping" command packet from the Base command set. A "Ping" command has no arguments. Its function is to determine if a device is present and responsive:

| Header  |                     |                                      |  | Packet Payload                               |  |                             | Checksum   |            |
|---|---------------------|--------------------------------------|--|--|--|-----------------------------|------------|------------|
| <i>SYNC1</i><br>"u"   | <i>SYNC2</i><br>"e" | <i>Descriptor</i><br><i>Set byte</i> | <i>Payload</i><br><i>Length</i><br><i>byte</i> | <i>Field</i><br><i>Byte</i><br><i>Length</i> | <i>Field</i><br><i>Descriptor</i><br><i>Byte</i> | <i>Field</i><br><i>Data</i> | <i>MSB</i> | <i>LSB</i> |
| 0x75  | 0x65                | 0x01                                 | 0x02   | 0x02   | 0x01   | N/A                         | 0xE0       | 0xC6       |
| <i>Copy-Paste version of command: "7565 0102 0201 E0C6"</i> |                     |                                      |  |  |  |                             |            |            |

The packet header has the "ue" starting sync bytes characteristic of all [MIP packets](#). The descriptor set byte (0x01) identifies the payload as being from the Base command set. The length of the payload portion is 2 bytes. The payload portion of the packet consists of one field. The field starts with the length of the field which is followed by the descriptor byte (0x01) of the field. The field descriptor value is the command value. Here the descriptor identifies the command as the "Ping" command from the Base command descriptor set. There are no parameters associated with the ping command, so the field data is empty. The checksum is a two byte [Fletcher checksum](#) (see the [MIP Packet Reference](#) for instructions on how to compute a Fletcher two byte checksum).

## 2.2.2 Example “Ping” Reply Packet

The “Ping” command will generate a reply packet from the device. The reply packet will contain an ACK/NACK field. The ACK/NACK field contains an “echo” of the command byte plus an error code. An error code of 0 is an “ACK” and a non-zero error code is a “NACK”:

| Header  |                  |                            |                            | Packet Payload           |                              |  | Checksum   |            |
|---|------------------|----------------------------|----------------------------|--------------------------|------------------------------|--|------------|------------|
| <i>SYNC1 “u”</i>  | <i>SYNC2 “e”</i> | <i>Descriptor Set byte</i> | <i>Payload Length byte</i> | <i>Field Byte Length</i> | <i>Field Descriptor Byte</i> | <i>Field Data</i>                      | <i>MSB</i> | <i>LSB</i> |
| 0x75  | 0x65             | 0x01                       | 0x04                       | 0x04                     | 0xF1                         | Command Echo: 0x01<br>Error code: 0x00 | 0xD5       | 0x6A       |
| <i>Copy-Paste version of reply:... “7565 0104 04F1 0100 D56A”</i> |                  |                            |                            |                          |                              |  |            |            |

The packet header has the “ue” starting sync bytes characteristic of all [MIP packets](#). The descriptor set byte (0x01) identifies the payload fields as being from the Base command set. The length of the payload portion is 4 bytes. The payload portion of the packet consists of one field. The field starts with the length of the field which is followed by the descriptor byte (0xF1) of the field. The field descriptor byte identifies the reply as the “ACK/NACK” from the Base command descriptor set. The field data consists of an “echo” of the original command (0x01) followed by the error code for the command (0x00). In this case the error is zero, so the field represents an “ACK”. Some examples of non-zero error codes that might be sent are “timeout”, “not implemented”, and “invalid parameter in command”. The checksum is a two byte [Fletcher checksum](#) (see the [MIP Packet Reference](#) for instructions on how to compute a Fletcher two byte checksum).

*The ACK/NACK descriptor value (0xF1) is the same in all descriptor sets. The value belongs to a set of reserved global descriptor values.*

*The reply packet may have additional fields that contain information in reply to the command. For example, requesting [Device Status](#) will result in a reply packet that contains two fields in the packet payload: an ACK/NACK field and a device status information field.*

## 2.3 Data Overview

Data packets are generated by the device. When the device is powered up, it may be configured to immediately stream data packets out to the host or it may be “idle” and waiting for a command to either start continuous data or to get data by “polling” (one data packet per request). Either way, the data packet is generated by the device in the same way.

### 2.3.1 Example Data Packet:

Below is an example of a MIP data packet which has one field that contains the scaled accelerometer vector.

| Header   |                     |                                      |                                      | Packet Payload                     |  |   | Checksum   |            |
|--|---------------------|--------------------------------------|--------------------------------------|------------------------------------|--|---|------------|------------|
| <i>SYNC1</i><br>“u”  | <i>SYNC2</i><br>“e” | <i>Descriptor</i><br><i>Set byte</i> | <i>Payload</i><br><i>Length byte</i> | <i>Field Byte</i><br><i>Length</i> | <i>Field</i><br><i>Descriptor</i><br><i>Byte</i> | <i>Field Data:</i><br><i>Accel vector (12 bytes,</i><br><i>3 float - X, Y, Z)</i> | <i>MSB</i> | <i>LSB</i> |
| 0x75   | 0x65                | 0x80                                 | 0x0E                                 | 0x0E                               | 0x04   | 0x3E 7A 63 A0<br>0xBB 8E 3B 29<br>0x7F E5 BF 7F                                   | 0x84       | 0xEE       |
| <i>Copy-Paste version: "7565 800E 0E04 3E7A 63A0 BB8E 3B29 7FE5 BF7F 84EE"</i> |                     |                                      |                                      |                                    |  |   |            |            |

The packet header has the “ue” starting sync bytes characteristic of all MIP packets. The descriptor set byte (0x80) identifies the payload field as being from the IMU data set. The length of the packet payload portion is 14 bytes (0x0E). The payload portion of the packet starts with the length of the field. "E The field descriptor byte (0x04) identifies the field data as the scaled accelerometer vector from the IMU data descriptor set. The field data itself is three single precision floating point values of 4 bytes each (total of 12 bytes) representing the X, Y, and Z axis values of the vector. The checksum is a two byte Fletcher checksum (see the [MIP Packet Reference](#) for instructions on how to compute a Fletcher two byte checksum).

The format of the field data is fully and unambiguously specified by the descriptor. In this example, the field descriptor (0x04) specifies that the field data holds an array of three single precision IEEE-754 floating point numbers in big-endian byte order and that the values represent units of “g’s” and the order of the values is X, Y, Z vector order. Any other specification would require a different descriptor (see the [Data Reference](#) section of this manual).

*Data polling commands generate two individual reply packets: An ACK/NACK packet and a data packet. Enable/Disable continuous data commands generate an ACK/NACK packet followed by the continuous stream of data packets.*

*The IMU and Estimation Filter data packets can be set up so that each data quantity is sent at a different rate. For example, you can setup continuous data to send the accelerometer vector at 100*

*Hz and the delta theta vector at 5 Hz. This means that packets will be sent at 100 Hz and each one will have the accelerometer vector but only every 20th packet will have the delta theta vector. This helps reduce bandwidth and buffering requirements. An example of this is given in the [IMU Message Format](#) command.*

## 2.4 Example Setup Sequence

Setup involves a series of command/reply pairs. The example below demonstrates actual setup sequences that you can send directly to the 3DM-GX5-45 either programmatically or by using a COM utility. In most cases only minor alterations will be needed to adapt these examples for your application.

### 2.4.1 Continuous Data Example Command Sequence

Most applications will operate with the 3DM-GX5-45 sending a continuous data stream. In the following example, the IMU data format is set, followed by the Estimation Filter data format. To reduce the amount of streaming data, if present during the configuration, the device is placed into the idle state while performing the device initialization; when configuration is complete, the required data streams are enabled to bring the device out of idle mode. Finally, the configuration is saved so that it will be loaded on subsequent power-ups, eliminating the need to perform the configuration again.

#### 1. Put the Device in Idle Mode

Send the "[Set To Idle](#)" command to put the device in the idle state (reply is ACK/NACK), disabling the data- streams. This is not required but reduces the parsing burden during initialization and makes visual confirmation of the commands easier.

|   | MIP Packet Header   |                     |                                      |                                 | Command/Reply Fields          |                                  |                                    | Checksum   |            |
|---|---------------------|---------------------|--------------------------------------|---------------------------------|-------------------------------|----------------------------------|------------------------------------|------------|------------|
|   | <i>SYNC1</i><br>"u" | <i>SYNC2</i><br>"e" | <i>Descriptor</i><br><i>Set byte</i> | <i>Payload</i><br><i>Length</i> | <i>Field</i><br><i>Length</i> | <i>Cmd.</i><br><i>Descriptor</i> | <i>Field Data</i>                  | <i>MSB</i> | <i>LSB</i> |
| <b>Command:</b><br><i>Set to Idle</i>                           | 0x75                | 0x65                | 0x01                                 | 0x02                            | 0x02                          | 0x02                             | N/A                                | 0xE1       | 0xC7       |
| <b>Reply:</b><br><i>ACK/NACK</i>                                | 0x75                | 0x65                | 0x01                                 | 0x04                            | 0x04                          | 0xF1                             | Cmd echo: 0x02<br>Error code: 0x00 | 0xD6       | 0x6C       |
| <i>Copy-Paste version of the command: "7565 0102 0202 E1C7"</i> |                     |                     |                                      |                                 |                               |                                  |                                    |            |            |

## 2. Configure the IMU Data-stream Format

Send a “Set IMU Message Format” command (reply is ACK/NACK). This example requests GPS correlation timestamp, scaled gyro, and scaled accelerometer information at 50 Hz (500Hz base rate divided by a rate decimation of 10 on the 3DM-GX5-45 = 50 Hz.) This will result in a single IMU data packet sent at 50Hz containing the IMU GPS correlation timestamp followed by the scaled gyro field and the scaled accelerometer field. This is a very typical configuration for a base level of inertial data. If different rates were requested, then each packet would only contain the data quantities that fall in the same decimation frame (see the [Multiple Rate Data](#) section). If the stream was not disabled in the previous step, the IMU data would begin stream immediately.

*Please note, this command will not append the requested descriptors to the current IMU data-stream configuration, it will overwrite it completely.*

|   | MIP Packet Header |              |                        |                   | Command/Reply Fields |                    |   | Checksum |      |
|---|-------------------|--------------|------------------------|-------------------|----------------------|--------------------|---|----------|------|
|   | SYNC1<br>“u”      | SYNC2<br>“e” | Descriptor<br>Set byte | Payload<br>Length | Field<br>Length      | Cmd.<br>Descriptor | Field Data  | MSB      | LSB  |
| <b>Command:</b><br><i>New IMU<br/>Message<br/>Format</i>                                    | 0x75              | 0x65         | 0x0C                   | 0x0D              | 0x0D                 | 0x08               | Function: 0x01<br>Desc. count: 0x03<br>GPS TS Desc.: 0x12<br>Rate Dec: 0x000A<br>Accel Desc.: 0x04<br>Rate Dec: 0x000A<br>Ang Rate Desc: 0x05<br>Rate Dec: 0x000A | 0x45     | 0xF2 |
| <b>Reply:</b><br><i>ACK/NACK</i>  | 0x75              | 0x65         | 0x0C                   | 0x04              | 0x04                 | 0xF1               | Cmd echo: 0x08<br>Error code: 0x00  | 0xE7     | 0xBA |
| <i>Copy-Paste version of the command: “7565 0C0D 0D08 0103 1200 0A04 000A 0500 0A45 F2”</i> |                   |              |                        |                   |                      |                    |   |          |      |



### 3. Configure the Estimation Filter Data-stream Format

The following configuration command requests the GPS Timestamp followed by the Estimated LLH Position, Estimated NED Velocity, Estimated Orientation in Quaternion form, and Filter Status at 50 Hz (500Hz base rate divided by a rate decimation of 10 on the 3DM-GX5-45 = 50 Hz.) This will result in a single IMU data packet sent at 50 Hz containing the requested fields in the requested order. If different rates were requested, then each packet would only contain the data quantities that fall in the same data rate frame (see the [Multiple Rate Data](#) section). If the stream was not disabled in the previous step, the Estimation Filter data would begin stream immediately.

*Please note, this command will not append the requested descriptors to the current Estimation Filter data stream configuration, it will overwrite it completely.*

|  | MIP Packet Header |              |                        |                   | Command/Reply Fields |               |  | Checksum |      |
|--|-------------------|--------------|------------------------|-------------------|----------------------|---------------|--|----------|------|
|  | SYNC1<br>"u"      | SYNC2<br>"e" | Descriptor<br>Set byte | Payload<br>Length | Field<br>Length      | Cmd.<br>Desc. | Field Data   | MSB      | LSB  |
| <b>Command:</b><br>New<br>Estimation<br>Filter<br>Message<br>Format  | 0x75              | 0x65         | 0x0C                   | 0x13              | 0x13                 | 0x0A          | Function: 0x01<br>Desc. count: 0x05<br>GPS TS Desc.: 0x11<br>Rate Dec: 0x000A<br>Filter Status Desc: 0x10<br>Rate Dec: 0x000A<br>Est. Pos. Desc.: 0x01<br>Rate Dec: 0x000A<br>Est. Vel. Desc.: 0x02<br>Rate Dec: 0x000A<br>Est. Quat. Desc: 0x03<br>Rate Dec: 0x000A | 0x75     | 0x62 |
| <b>Reply:</b><br>ACK/NACK  | 0x75              | 0x65         | 0x0C                   | 0x04              | 0x04                 | 0xF1          | Cmd echo: 0x0A<br>Error code: 0x00   | 0xE9     | 0xBE |
| <i>Copy-Paste version of the command: "7565 0C13 130A 0105 1100 0A10 000A 0100 0A02 000A 0300 0A75 62"</i> |                   |              |                        |                   |                      |               |  |          |      |

#### 4. Save the IMU and Estimation Filter MIP Message Format

To save the IMU and Estimation Filter MIP Message format, use the “Save” function selector (0x03) in the IMU and Estimation Filter Message Format commands. Below we’ve combined the two commands as two fields in the same packet. Notice that the two reply ACKs comes in one packet also. Alternatively, they could be sent as separate packets.

|   | MIP Packet Header   |                     |                                      |                                 | Command/Reply Fields          |                             |                                     | Checksum   |            |
|---|---------------------|---------------------|--------------------------------------|---------------------------------|-------------------------------|-----------------------------|-------------------------------------|------------|------------|
|   | <i>SYNC1</i><br>“u” | <i>SYNC2</i><br>“e” | <i>Descriptor</i><br><i>Set byte</i> | <i>Payload</i><br><i>Length</i> | <i>Field</i><br><i>Length</i> | <i>Cmd.</i><br><i>Desc.</i> | <i>Field Data</i>                   | <i>MSB</i> | <i>LSB</i> |
| <b>Command Field 1:</b><br><i>Save Current IMU Message Format</i>               | 0x75                | 0x65                | 0x0C                                 | 0x08                            | 0x04                          | 0x08                        | Function: 0x03<br>Desc. count: 0x00 |            |            |
| <b>Command Field 2:</b><br><i>Save Current Estimation Filter Message Format</i> |                     |                     |                                      |                                 | 0x04                          | 0x0A                        | Function: 0x03<br>Desc. count: 0x00 | 0x0E       | 0x31       |
| <b>Reply Field 1:</b><br><i>ACK/NACK</i>  | 0x75                | 0x65                | 0x0C                                 | 0x08                            | 0x04                          | 0xF1                        | Cmd echo: 0x08<br>Error code: 0x00  |            |            |
| <b>Reply Field 2:</b><br><i>ACK/NACK</i>  |                     |                     |                                      |                                 | 0x04                          | 0xF1                        | Cmd echo: 0x0A<br>Error code: 0x00  | 0xEA       | 0x71       |
| <i>Copy-Paste version of the command: “7565 0C08 0408 0300 040A 0300 0E31”</i>  |                     |                     |                                      |                                 |                               |                             |                                     |            |            |

## 5. Enable the IMU and Estimation Filter Data-streams

Send an [Enable/Disable Continuous Stream](#) command to enable the IMU and Estimation Filter continuous streams (reply is ACK). These streams may have already been enabled by default; this step is to confirm they are enabled. These streams will begin streaming data immediately.

|  | MIP Packet Header   |                     |                                      |                                 | Command/Reply Fields          |                             |  | Checksum   |            |
|--|---------------------|---------------------|--------------------------------------|---------------------------------|-------------------------------|-----------------------------|--|------------|------------|
|  | <i>SYNC1</i><br>"u" | <i>SYNC2</i><br>"e" | <i>Descriptor</i><br><i>Set byte</i> | <i>Payload</i><br><i>Length</i> | <i>Field</i><br><i>Length</i> | <i>Cmd.</i><br><i>Desc.</i> | <i>Field Data</i>  | <i>MSB</i> | <i>LSB</i> |
| <b>Command Field 1:</b><br><i>Enable Continuous IMU Message</i>                      | 0x75                | 0x65                | 0x0C                                 | 0x0A                            | 0x05                          | 0x11                        | Function: 0x01<br>IMU: 0x01<br>On: 0x01                  |            |            |
| <b>Command Field 2:</b><br><i>Enable Continuous Estimation Filter Message</i>        |                     |                     |                                      |                                 | 0x05                          | 0x11                        | Function: 0x01<br>Estimation Filter:<br>0x03<br>On: 0x01 | 0x24       | 0xCC       |
| <b>Reply Field 1:</b><br><i>ACK/NACK</i>   | 0x75                | 0x65                | 0x0C                                 | 0x08                            | 0x04                          | 0xF1                        | Cmd echo: 0x11<br>Error code: 0x00                       |            |            |
| <b>Reply Field 2:</b><br><i>ACK/NACK</i>   |                     |                     |                                      |                                 | 0x04                          | 0xF1                        | Cmd echo: 0x11<br>Error code: 0x00                       | 0xFA       | 0xB5       |
| <i>Copy-Paste version of the command: "7565 0C0A 0511 0101 0105 1101 0301 24 CC"</i> |                     |                     |                                      |                                 |                               |                             |  |            |            |

## 6. Resume the Device: (Optional)

Sending the “Resume” command is another method of re-enabling transmission of enabled data streams. If the "Resume" command is sent *before* the "Enable IMU Data Stream" command, the node will resume the state it was in when the "Idle" command was sent. If the "Resume" command is sent *after* enabling the IMU Data Stream, the node will continue streaming. (reply is ACK/NACK).

|   | MIP Packet Header   |                     |                                      |                                 | Command/Reply Fields          |                             |                                    | Checksum   |            |
|---|---------------------|---------------------|--------------------------------------|---------------------------------|-------------------------------|-----------------------------|------------------------------------|------------|------------|
|   | <i>SYNC1</i><br>"u" | <i>SYNC2</i><br>"e" | <i>Descriptor</i><br><i>Set byte</i> | <i>Payload</i><br><i>Length</i> | <i>Field</i><br><i>Length</i> | <i>Cmd.</i><br><i>Desc.</i> | <i>Field Data</i>                  | <i>MSB</i> | <i>LSB</i> |
| <b>Command:</b><br><i>Resume</i>                                | 0x75                | 0x65                | 0x01                                 | 0x02                            | 0x02                          | 0x06                        | N/A                                | 0xE5       | 0xCB       |
| <b>Reply:</b><br><i>ACK/NACK</i>                                | 0x75                | 0x65                | 0x01                                 | 0x04                            | 0x04                          | 0xF1                        | Cmd echo: 0x06<br>Error code: 0x00 | 0xDA       | 0x74       |
| <i>Copy-Paste version of the command: "7565 0102 0206 E5CB"</i> |                     |                     |                                      |                                 |                               |                             |                                    |            |            |

## 7. Initialize the Filter

At this point in the setup, the 3DM-GX5-45 is streaming data, but the Kalman Filter is not yet initialized. For a successful initialization to occur the GNSS must have a fix and the initial orientation must be known. The orientation may be initialized in different ways: Setting all of the attitude elements manually, setting only the heading and allowing the device to determine pitch and roll, using the internal IMU solution (which requires the magnetometers) to provide the initial orientation, or via auto-initialization, which uses the chosen heading update source to initialize. In this example, we will assume the magnetometers are available and use the IMU solution to initialize the Kalman Filter. Once the attitude is initialized and the GPS fix becomes valid, the Kalman Filter estimation will propagate. Note that this step is not necessary if you have the auto-initialize option enabled:

### Poll for current Complementary Filter Euler Angle output:

|  | MIP Packet Header   |                     |                            |                                 | Command/Reply Fields          |                             |   | Checksum   |            |
|--|---------------------|---------------------|----------------------------|---------------------------------|-------------------------------|-----------------------------|---|------------|------------|
|  | <i>SYNC1</i><br>"u" | <i>SYNC2</i><br>"e" | <i>Desc.</i><br><i>Set</i> | <i>Payload</i><br><i>Length</i> | <i>Field</i><br><i>Length</i> | <i>Cmd.</i><br><i>Desc.</i> | <i>Field Data</i>   | <i>MSB</i> | <i>LSB</i> |
| <b>Command:</b><br><i>Poll for CF Euler</i>                                  | 0x75                | 0x65                | 0x0C                       | 0x07                            | 0x07                          | 0x01                        | Function: 0x00<br>Field Count: 0x00<br>Euler Desc: 0x06<br>Reserved: 0x00 | 0x02       | 0xFC       |
| <b>Reply Field 1:</b><br><i>ACK/NACK</i>                                     | 0x75                | 0x65                | 0x0C                       | 0x04                            | 0x04                          | 0xF1                        | Cmd echo: 0x01<br>Error code: 0x00  | 0xE0       | 0xAC       |
| <b>Reply Field 2:</b><br><i>Data Packet</i>                                  | 0x75                | 0x65                | 0x80                       | 0x0E                            | 0x0E                          | 0x0C                        | Roll: 0xBAE3ED9B<br>Pitch:<br>0x3C7D6DDF<br>Yaw: 0xBF855CF5               | 0x41       | 0xBB       |
| <i>Copy-Paste version of the command: "7565 0C07 0701 0001 0C00 0002 FC"</i> |                     |                     |                            |                                 |                               |                             |   |            |            |

### Initialize attitude:

|   | MIP Packet Header   |                     |                            |                                 | Command/Reply Fields          |                             |   | Checksum   |            |
|---|---------------------|---------------------|----------------------------|---------------------------------|-------------------------------|-----------------------------|---|------------|------------|
|   | <i>SYNC1</i><br>"u" | <i>SYNC2</i><br>"e" | <i>Desc.</i><br><i>Set</i> | <i>Payload</i><br><i>Length</i> | <i>Field</i><br><i>Length</i> | <i>Cmd.</i><br><i>Desc.</i> | <i>Field Data</i>   | <i>MSB</i> | <i>LSB</i> |
| <b>Command:</b><br><i>Initialize Attitude</i>   | 0x75                | 0x65                | 0x0D                       | 0x06                            | 0x06                          | 0x02                        | Roll: 0xBAE3ED9B<br>Pitch:<br>0x3C7D6DDF<br>Yaw: 0xBF855CF5 | 0xC4       | 0x09       |
| <b>Reply :</b><br><i>ACK/NACK</i>   | 0x75                | 0x65                | 0x0D                       | 0x04                            | 0x04                          | 0xF1                        | Cmd echo: 0x02<br>Error code: 0x00                          | 0xE2       | 0xB4       |
| <i>Copy-Paste version of the command: "7565 0D0E 0E02 BAE3 ED9B 3C7D 6DDF BF85 5CF5 C409"</i> |                     |                     |                            |                                 |                               |                             |   |            |            |

## 2.4.2 Polling Data Example Sequence

Polling for data is less efficient than processing a continuous data stream, but may be more appropriate for certain applications. The main difference from the continuous data example is the inclusion of the Poll data commands in the data loop:

- 1. Put the Device in Idle Mode (Disabling the data-streams)**  
Same as continuous streaming (*Put the Device in Idle Mode*).
- 2. Configure the IMU data-stream format**  
Same as continuous streaming (*Configure the IMU Data-stream Format*).
- 3. Configure the Estimation Filter data-stream format**  
Same as continuous streaming (*Configure the Estimation Filter Data-stream Format*).
- 4. Save the IMU and Estimation Filter MIP Message format**  
Same as continuous streaming (*Save the IMU and Estimation Filter MIP Message Format*).
- 5. Enable the IMU and Estimation Filter data-streams**  
Same as continuous streaming (*Enable the IMU and Estimation Filter Data-streams*).
- 6. Resume the Device**  
Returns to the state when Idle was called, except for when Enable Stream command is sent (*Resume the Device: (Optional)*).
- 7. Initialize the Filter**  
Same as continuous streaming (*Initialize the Filter*).

### Send Individual Data Polling Commands

Send individual [Poll IMU Data](#) and [Poll Estimation Filter Data](#) commands in your data collection loop. After the ACK/NACK is sent by the device, a single data packet will be sent according to the settings in the previous steps. Note that the ACK/NACK has the same descriptor set value as the command, but the data packet has the descriptor set value for the type of data (IMU or Estimation Filter):

|  | MIP Packet Header   |                     |                            |                                 | Command/Reply Fields          |                             |   | Checksum   |            |
|--|---------------------|---------------------|----------------------------|---------------------------------|-------------------------------|-----------------------------|---|------------|------------|
|  | <i>SYNC1</i><br>"u" | <i>SYNC2</i><br>"e" | <i>Desc.</i><br><i>Set</i> | <i>Payload</i><br><i>Length</i> | <i>Field</i><br><i>Length</i> | <i>Cmd.</i><br><i>Desc.</i> | <i>Field Data</i>                               | <i>MSB</i> | <i>LSB</i> |
| <b>Command:</b><br><i>Poll IMU Data</i>                              | 0x75                | 0x65                | 0x0C                       | 0x04                            | 0x04                          | 0x01                        | Option: 0x00<br>Desc Count: 0x00                | 0xEF       | 0xDA       |
| <b>Reply Field 1:</b><br><i>ACK/NACK</i>                             | 0x75                | 0x65                | 0x0C                       | 0x04                            | 0x04                          | 0xF1                        | Cmd echo: 0x01<br>Error code: 0x00              | 0xE0       | 0xAC       |
| <b>IMU Data</b><br><b>Packet Field 1:</b><br><i>Gyro Vector</i>      | 0x75                | 0x65                | 0x80                       | 0x1C                            | 0x0E                          | 0x04                        | 0x3E 7A 63 A0<br>0xBB 8E 3B 29<br>0x7F E5 BF 7F | 0x41       | 0xBB       |
| <b>IMU Data</b><br><b>Packet Field 2:</b><br><i>Accel Vector</i>     |                     |                     |                            |                                 | 0x0E                          | 0x03                        | 0x3E 7A 63 A0<br>0xBB 8E 3B 29<br>0x7F E5 BF 7F | 0xAD       | 0xDC       |
| <i>Copy-Paste version of the command: "7565 0C04 0401 0000 EFDA"</i> |                     |                     |                            |                                 |                               |                             |   |            |            |

You may specify the format of the data packet on a per-polling-command basis rather than using the pre-set data format (see the [Poll IMU Data](#) and [Poll Estimation Filter Data](#) sections).

The polling command has an option to suppress the ACK/NACK in order to keep the incoming stream clear of anything except data packets. Set the option byte to 0x01 for this feature.

## 2.5 Parsing Incoming Packets

Setup is usually the easy part of programming the 3DM-GX5-45. Once you start continuous data streaming, parsing and processing the incoming data packet stream will become the primary focus. The stream of data from the IMU and Kalman Filter (Estimation Filter) are usually the dominant source of data since they come in the fastest. Polling for data may seem to be a logical solution to controlling the data flow, and this may be appropriate for some applications, but if your application requires the precise delivery of inertial data, it is often necessary to have the data stream drive the process rather than having the host try to control the data stream through polling.

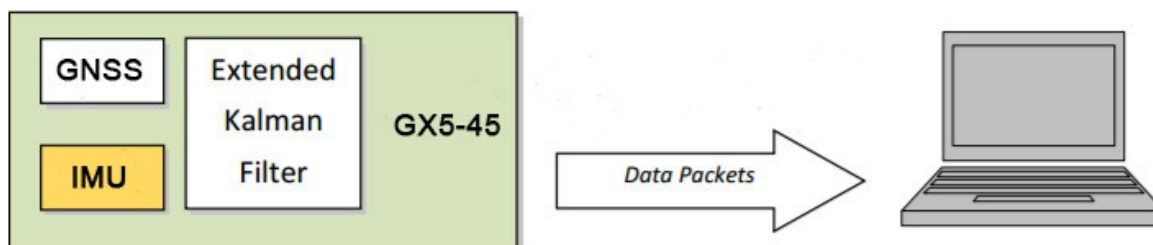

The “descriptor set” qualifier in the MIP packet header is a feature that greatly aids the management of the incoming packet stream by making it easy to sort the packets into logical sub-streams and route those streams to appropriate handlers. The first step is to parse the incoming character stream into packets.

It is important to take an organized approach to parsing continuous data. The basic strategy is this: parse the incoming stream of characters for the packet starting sequence “ue” and then wait for the entire packet to come in based on the packet length byte which arrives after the “ue” and descriptor set byte. Make sure you have a timeout on your wait loop in case your stream is out of sync and the starting “ue” sequence winds up being a “ghost” sequence. If you timeout, restart the parsing with the first character after the ghost “ue”. Once the stream is in sync, it is rare that you will hit a timeout unless you have an unreliable communications link. After verifying the checksum, examine the “descriptor set” field in the header of the packet. This tells you immediately how to handle the packet.

Based on the value of the descriptor set field in the packet header, pass the packet to either a command handler (if it is a Base command or 3DM command descriptor set) or a data handler (if it is an IMU, or Estimation Filter data set). Since you know beforehand that the IMU and Estimation Filter data packets will be coming in fastest, you can tune your code to buffer or handle these packets at a high priority. Replies to commands generally happen sequentially after a command so the incidence of these is under program control.

For multi-threaded applications, it is often useful to use queues to buffer packets bound for different packet handler threads. The depth of the queue can be tuned so that no packets are dropped while



waiting for their associated threads to process the packets in the queue. See [Advanced Programming Models](#) section for more information on this topic.

Once you have sorted the different packets and sent them to the proper packet handler, the packet handler may parse the packet payload fields and handle each of the fields as appropriate for the application. For simple applications, it is perfectly acceptable to have a single handler for all packet types. Likewise, it is perfectly acceptable for a single parser to handle both the packet type and the fields in the packet. The ability to sort the packets by type is just an option that simplifies the implementation of more sophisticated applications.

## 2.6 Multiple Rate Data

The message format commands ([IMU Message Format](#) and [Estimation Filter Message Format](#)) allow you to set different data rates for different data quantities. This is a very useful feature especially for IMU data because some data, such as accelerometer and gyroscope data, usually requires higher data rates (>100 Hz) than other IMU data such as Magnetometer (20 Hz typical) data. The ability to send data at different rates reduces the parsing load on the user program and decreases the bandwidth requirements of the communications channel. Multiple rate data is scheduled on a common sampling rate clock. This means that if there is more than one data rate scheduled, the schedules coincide periodically. For example, if you request Accelerometer data at 100 Hz and Magnetometer data at 50 Hz, the magnetometer schedule coincides with the Accelerometer schedule 50% of the time. When the schedules coincide, then the two data quantities are delivered in the same packet. In other words, in this example, you will receive data packets at 100 Hz and every packet will have an accelerometer data field and EVERY OTHER packet will also include a magnetometer data field:

| <i>Packet 1</i> | <i>Packet 2</i> | <i>Packet 3</i> | <i>Packet 4</i> | <i>Packet 5</i> | <i>Packet 6</i> | <i>Packet 7</i> | <i>Packet 8</i> | ...   |
|-----------------|-----------------|-----------------|-----------------|-----------------|-----------------|-----------------|-----------------|-------|
| Accel           | Accel<br>Mag    | Accel           | Accel<br>Mag    | Accel           | Accel<br>Mag    | Accel           | Accel<br>Mag    | Accel |

If a timestamp is included at 100 Hz, then the timestamp will also be included in every packet in this example. It is important to note that *the data in a packet with a timestamp is always synchronous with the timestamp*. This assures that multiple rate data is always synchronous.

| <i>Packet 1</i>    | <i>Packet 2</i>           | <i>Packet 3</i>    | <i>Packet 4</i>           | <i>Packet 5</i>    | <i>Packet 6</i>           | ...   |
|--------------------|---------------------------|--------------------|---------------------------|--------------------|---------------------------|-------|
| Accel<br>Timestamp | Accel<br>Mag<br>Timestamp | Accel<br>Timestamp | Accel<br>Mag<br>Timestamp | Accel<br>Timestamp | Accel<br>Mag<br>Timestamp | Accel |

## 2.7 Data Synchronicity

Because the MIP packet allows multiple data fields to be in a single packet, it may be assumed that a single timestamp field in the packet applies to all the data in the packet. In other words, it may be assumed that all the data fields in the packet were sampled at the same time.

IMU and Estimation Filter data are generated independently by two systems with different clocks. The importance of time is different in each system and the data they produce. The IMU data requires precise microsecond resolution and perfectly regular intervals in its timestamps. The Kalman Filter resides on a separate processor and must derive its timing information from the two data sources.

The time base difference is one of the factors that necessitate separation of the IMU and Estimation Filter data into separate packets. Conversely, the common time base of the different data quantities within one system is what allows grouping multiple data quantities into a single packet with a common timestamp. In other words, IMU data is always grouped with a timestamp generated from the IMU time base, and estimation filter data is always grouped with a timestamp from the Estimation Filter time base, etc.

All data streams (IMU and Estimation Filter) on the 3DM-GX5-45 output a “GPS Time”- formatted timestamp. This allows a precise common time base for all data. Due to the differences in clocks on each device, the period between two consecutive timestamp values may not be constant; this occurs because periodic corrections are applied to the IMU and Estimation Filter timestamps when the GPS Time Update Command is applied.

## 2.8 Communications Bandwidth Management

Because of the large amount and variety of data that is available from the 3DM-GX5-45, it is quite easy to overdrive the bandwidth of the communications channel. This can result in dropped packets. The 3DM-GX5-45 does not do analysis of the bandwidth requirements for any given output data configuration, it will simply drop a packet if its internal serial buffer is being filled faster than it is being emptied. It is up to the programmer to analyze the size of the data packets requested and the available bandwidth of the communications channel. Often the best way to determine this is empirically by trying different settings and watching for dropped packets. Below are some guidelines on how to determine maximum bandwidth for your application.

## 2.8.1 UART Bandwidth Calculation

Below is an equation for the maximum theoretical UART baud rate for a given message configuration. Although it is possible to calculate the approximate bandwidth required for a given setup, there is no guarantee that the system can support that setup due to internal processing delays. The best approach is to try a setting based on an initial estimate and watch for dropped packets. If there are dropped packets, increase the baud rate, reduce the data rate, or decrease the size or number of packets.

$$n(k \times f_{mr}) + n \sum (S_f \times f_{dr})$$

Where:

$S_f$  = size of data field in bytes

$f_{dr}$  = field of data rate in Hz

$f_{mr}$  = maximum data rate in Hz

$n$  = size of UART word = 10 bits

$k$  = size of MIP wrapper = 6 bytes

which becomes:

$$60f_{mr} + 10 \sum (S_f \times f_{dr})$$

### Example:

For an IMU message format of Accelerometer Vector (14 byte data field) + Internal Timestamp (six byte data field), both at 100 Hz, the theoretical minimum baud rate would be:

$$\begin{aligned} &= 60 \times 100 + 10((14 \times 100) + (6 \times 100)) \\ &= 26000 \text{ BAUD} \end{aligned}$$

In practice, if you set the baud rate to 115200 the packets come through without any packet drops. If you set the baud rate to the next available lower rate of 19200, which is lower than the calculated

minimum, you get regular packet drops. The only way to determine a packet drop is by observing a timestamp in sequential packets. The interval should not change from packet to packet. If it does change then packets were dropped.

## 2.8.2 USB vs. UART

The 3DM-GX5-45 has a dual communication interface: USB or UART. There is an important difference between USB and UART communication with regards to data bandwidth. The USB “virtual COM port” that the 3DM-GX5-45 implements runs at USB “full-speed” setting of 12Mbs (megabits per second). However, USB is a polled master-slave system and so the slave (3DM-GX5-45) can only communicate when polled by the master. This results in inconsistent data streaming - that is, the data comes in spurts rather than at a constant rate and, although rare, sometimes data can be dropped if the host processor fails to poll the USB device in a timely manner.

With the UART the opposite is true. The 3DM-GX5-45 operates without UART handshaking which means it streams data out at a very consistent rate without stopping. Since the host processor has no handshake method of pausing the stream, it must instead make sure that it can process the incoming packet stream non-stop without dropping packets.

In practice, USB and UART communications behave similarly on a Windows based PC, however, UART is the preferred communications system if consistent, deterministic communications timing behavior is required. USB is preferred if you require more data than is possible over the UART and you can tolerate the possibility of variable latency in the data delivery and very occasional packet drops due to host system delays in servicing the USB port.

### 3. Command and Data Summary

Below is a summary of the commands and data available in the programming interface. Commands and data are denoted by two values. The first value denotes the “descriptor set” that the command or data belongs to (Base command, 3DM command, Estimation Filter Command, IMU data, GNSS data, or Estimation Filter data) and the second value denotes the unique command or data “descriptor” in that set. The pair of values constitutes a “full descriptor”.

#### 3.1 Commands

##### 3.1.1 Base Command Set (0x01)

|                                     |              |
|-------------------------------------|--------------|
| Ping                                | (0x01, 0x01) |
| Set to Idle                         | (0x01, 0x02) |
| Get Device Information              | (0x01, 0x03) |
| Get Device Descriptor Sets          | (0x01, 0x04) |
| Device Built-In Test (BIT)          | (0x01, 0x05) |
| Resume                              | (0x01, 0x06) |
| Get Extended Device Descriptor Sets | (0x01, 0x07) |
| GPS Time Update                     | (0x01, 0x72) |
| Device Reset                        | (0x01, 0x7E) |

##### 3.1.2 3DM Command Set (0x0C)

|  |              |
|--|--------------|
| Poll IMU Data                                | (0x0C, 0x01) |
| Poll GNSS Data                               | (0x0C, 0x02) |
| Poll Estimation Filter Data                  | (0x0C, 0x03) |
| Get IMU Data Rate Base                       | (0x0C, 0x06) |
| Get GNSS Data Rate Base                      | (0x0C, 0x07) |
| Get Estimation Filter Data Rate Base         | (0x0C, 0x0B) |
| IMU Message Format                           | (0x0C, 0x08) |
| GNSS Message Format                          | (0x0C, 0x09) |
| Estimation Filter Message Format             | (0x0C, 0x0A) |
| Enable/Disable Device Continuous Data Stream | (0x0C, 0x11) |
| GNSS Constellation Settings                  | (0x0C, 0x21) |
| GNSS SBAS Settings                           | (0x0C, 0x22) |
| GNSS Assisted Fix Control                    | (0x0C, 0x23) |
| GNSS Assist Time Update                      | (0x0C, 0x24) |
| Device Startup Settings                      | (0x0C, 0x30) |
| Accel Bias                                   | (0x0C, 0x37) |
| Gyro Bias                                    | (0x0C, 0x38) |
| Capture Gyro Bias                            | (0x0C, 0x39) |
| Magnetometer Hard Iron Offset                | (0x0C, 0x3A) |

|                                   |              |
|-----------------------------------|--------------|
| Magnetometer Soft Iron Matrix     | (0x0C, 0x3B) |
| Coning and Sculling Enable        | (0x0C, 0x3E) |
| Change UART Baud rate             | (0x0C, 0x40) |
| Advanced Low-Pass Filter Settings | (0x0C, 0x50) |
| Complementary Filter Settings     | (0x0C, 0x51) |
| Device Status*                    | (0x0C, 0x64) |
| Raw RTCM 2.3 Message              | (0x0C, 0x20) |

### 3.1.3 Estimation Filter Command Set (0x0D)

|  |              |
|--|--------------|
| Reset Filter                                 | (0x0D, 0x01) |
| Set Initial Attitude                         | (0x0D, 0x02) |
| Set Initial Heading                          | (0x0D, 0x03) |
| Vehicle Dynamics Mode                        | (0x0D, 0x10) |
| Sensor to Vehicle Frame Transformation       | (0x0D, 0x11) |
| Sensor to Vehicle Frame Offset               | (0x0D, 0x12) |
| Antenna Offset                               | (0x0D, 0x13) |
| Estimation Control Flags                     | (0x0D, 0x14) |
| GNSS Source Control                          | (0x0D, 0x15) |
| External GNSS Update                         | (0x0D, 0x16) |
| Heading Update Control                       | (0x0D, 0x18) |
| External Heading Update                      | (0x0D, 0x17) |
| External Heading Update with Timestamp       | (0x0D, 0x1F) |
| Pitch-Roll Aiding Control                    | (0x0D, 0x4B) |
| Altitude Aiding Control                      | (0x0D, 0x47) |
| Auto-Initialization Control                  | (0x0D, 0x19) |
| Magnetometer Noise Standard Deviation        | (0x0D, 0x42) |
| Gravity Noise Standard Deviation             | (0x0D, 0x28) |
| Pressure Altitude Noise Standard Deviation   | (0x0D, 0x29) |
| Accelerometer Noise Standard Deviation       | (0x0D, 0x1A) |
| Accelerometer Bias Model Parameters          | (0x0D, 0x1C) |
| Gyroscope Noise Standard Deviation           | (0x0D, 0x1B) |
| Gyroscope Bias Model Parameters              | (0x0D, 0x1D) |
| Hard Iron Offset Process Noise               | (0x0D, 0x2B) |
| Soft Iron Matrix Process Noise               | (0x0D, 0x2C) |
| Zero Velocity Update Control                 | (0x0D, 0x1E) |
| Zero Angular Rate Update Control             | (0x0D, 0x20) |
| Tare Orientation                             | (0x0D, 0x21) |
| Commanded Zero Velocity Update               | (0x0D, 0x22) |
| Commanded Zero Angular Rate Update           | (0x0D, 0x23) |
| Declination Source                           | (0x0D, 0x43) |
| Inclination Source                           | (0x0D, 0x4C) |
| Magnetic Field Magnitude Source              | (0x0D, 0x4D) |
| Gravity Magnitude Error Adaptive Measurement | (0x0D, 0x44) |

|   |              |
|---|--------------|
| Magnetometer Magnitude Error Adaptive Measurement | (0x0D, 0x45) |
| Magnetometer Dip Angle Error Adaptive Measurement | (0x0D, 0x46) |
| Magnetometer Capture Auto Calibration             | (0x0D, 0x27) |

### 3.1.4 System Command Set (0x7F)

|                     |              |
|---------------------|--------------|
| Communication Mode* | (0x7F, 0x10) |
|---------------------|--------------|

*\*Advanced commands*

## 3.2 Data

### 3.2.1 IMU Data Set (0x80)

|                                 |              |
|---------------------------------|--------------|
| Scaled Accelerometer Vector     | (0x80, 0x04) |
| Scaled Gyro Vector              | (0x80, 0x05) |
| Scaled Magnetometer Vector      | (0x80, 0x06) |
| Scaled Ambient Pressure         | (0x80, 0x17) |
| Delta Theta Vector              | (0x80, 0x07) |
| Delta Velocity Vector           | (0x80, 0x08) |
| CF Orientation Matrix           | (0x80, 0x09) |
| CF Quaternion                   | (0x80, 0x0A) |
| CF Euler Angles                 | (0x80, 0x0C) |
| CF Stabilized MagVector (North) | (0x80, 0x10) |
| CF Stabilized AccelVector (Up)  | (0x80, 0x11) |
| GPS Correlation Timestamp       | (0x80, 0x12) |

### 3.2.2 GNSS Data Set (0x81)

|                                 |              |
|---------------------------------|--------------|
| LLH Position                    | (0x81, 0x03) |
| ECEF Position                   | (0x81, 0x04) |
| NED Velocity                    | (0x81, 0x05) |
| ECEF Velocity                   | (0x81, 0x06) |
| Dilution of Precision(DOP) Data | (0x81, 0x07) |
| UTC Time                        | (0x81, 0x08) |
| GPS Time                        | (0x81, 0x09) |
| Clock Information               | (0x81, 0x0A) |
| GNSS Fix Information            | (0x81, 0x0B) |
| Space-Vehicle Information (SVI) | (0x81, 0x0C) |
| Hardware Status                 | (0x81, 0x0D) |
| DGNSS Information               | (0x81, 0x0E) |
| DGNSS Channel Status            | (0x81, 0x0F) |

### 3.2.3 Estimation Filter Data Set (0x82)

|  |              |
|--|--------------|
| Filter Status                              | (0x82, 0x10) |
| GPS Timestamp                              | (0x82, 0x11) |
| LLH Position                               | (0x82, 0x01) |
| LLH Position Uncertainty                   | (0x82, 0x08) |
| NED Velocity                               | (0x82, 0x02) |
| NED Velocity Uncertainty                   | (0x82, 0x09) |
| Orientation, Quaternion                    | (0x82, 0x03) |
| Attitude Uncertainty, Quaternion Elements  | (0x82, 0x12) |
| Orientation, Euler Angles                  | (0x82, 0x05) |
| Attitude Uncertainty, Euler Angles         | (0x82, 0x0A) |
| Orientation, Matrix                        | (0x82, 0x04) |
| Compensated Angular Rate                   | (0x82, 0x0E) |
| Gyro Bias                                  | (0x82, 0x06) |
| Gyro Bias Uncertainty                      | (0x82, 0x0B) |
| Gyro Scale Factor                          | (0x82, 0x16) |
| Gyro Scale Factor Uncertainty              | (0x82, 0x18) |
| Compensated Linear Acceleration            | (0x82, 0x1C) |
| Linear Acceleration                        | (0x82, 0x0D) |
| Accel Bias                                 | (0x82, 0x07) |
| Accel Bias Uncertainty                     | (0x82, 0x0C) |
| Accel Scale Factor                         | (0x82, 0x17) |
| Accel Scale Factor Uncertainty             | (0x82, 0x19) |
| Pressure Altitude                          | (0x82, 0x21) |
| Standard Atmosphere Model                  | (0x82, 0x20) |
| Gravity Vector                             | (0x82, 0x13) |
| WGS84 Local Gravity Magnitude              | (0x82, 0x0F) |
| Heading Update Source State                | (0x82, 0x14) |
| Magnetic Model Solution                    | (0x82, 0x15) |
| Mag Auto Hard Iron Offset                  | (0x82, 0x25) |
| Mag Auto Hard Iron Offset Uncertainty      | (0x82, 0x28) |
| Mag Auto Soft Iron Matrix                  | (0x82, 0x26) |
| Mag Auto Soft Iron Matrix Uncertainty      | (0x82, 0x29) |
| GNSS Antenna Offset Correction             | (0x82, 0x30) |
| GNSS Antenna Offset Correction Uncertainty | (0x82, 0x31) |



## 4. Command Reference

### 4.1 Base Commands

The Base command set is common to many LORD Sensing devices. With the Base command set it is possible to identify many properties and do basic functions on a device even if you do not recognize its specialized functionality or data. The commands work the same way on all devices that implement this set.

| 4.1.1 Ping (0x01, 0x01)   |   |                         |                  |                       |  |                    |  |            |            |
|---|---|-------------------------|------------------|-----------------------|--|--------------------|--|------------|------------|
| <b>Description</b>  | Send "Ping" command<br>Device responds with ACK if present. |                         |                  |                       |  |                    |  |            |            |
| <b>Field Format</b>   | <i>Field Length</i>   | <i>Field Descriptor</i> |                  |                       | <i>Field Data</i>  |                    |  |            |            |
| <i>Command</i>  | 0x02  | 0x01                    |                  |                       | N/A  |                    |  |            |            |
| <i>Reply:<br/>ACK/NACK</i>                                      | 0x04  | 0xF1                    |                  |                       | U8 - echo the command byte<br>U8 - error code (0: ACK, non-zero: NACK) |                    |  |            |            |
| <b>Example</b>  | MIP Packet Header   |                         |                  |                       | Command/Reply Fields   |                    |  | Checksum   |            |
|   | <i>Sync1</i>  | <i>Sync2</i>            | <i>Desc. Set</i> | <i>Payload Length</i> | <i>Field Length</i>  | <i>Field Desc.</i> | <i>Field Data</i>                      | <i>MSB</i> | <i>LSB</i> |
| <i>Command:<br/>Ping</i>  | 0x75  | 0x65                    | 0x01             | 0x02                  | 0x02   | 0x01               |  | 0xE0       | 0xC6       |
| <i>Reply:<br/>ACK/NACK</i>                                      | 0x75  | 0x65                    | 0x01             | 0x04                  | 0x04   | 0xF1               | Command echo: 0x01<br>Error code: 0x00 | 0xD5       | 0x6A       |
| <i>Copy-Paste version of the command: "7565 0102 0201 E0C6"</i> |   |                         |                  |                       |  |                    |  |            |            |

## 4.1.2 Set To Idle (0x01, 0x02)

|   |  |              |                  |                         |                      |  |  |            |            |
|---|--|--------------|------------------|-------------------------|----------------------|--|--|------------|------------|
| <b>Description</b>  | Place device into idle mode<br><br>Command has no parameters. Device responds with ACK if successfully placed in idle mode. This command will suspend streaming (if enabled) to allow it to respond to status and setup commands. You may restore the device mode by issuing the <a href="#">Resume</a> command. |              |                  |                         |                      |  |  |            |            |
| <b>Field Format</b>   | <i>Field Length</i>  |              |                  | <i>Field Descriptor</i> |                      | <i>Field Data</i>  |  |            |            |
| <i>Command</i>  | 0x02   |              |                  | 0x02                    |                      | N/A  |  |            |            |
| <i>Reply: ACK/<br/>NACK</i>                                     | 0x04   |              |                  | 0xF1                    |                      | U8 - echo the command byte<br>U8 - error code (0: ACK, non-zero: NACK) |  |            |            |
| <b>Example</b>  | MIP Packet Header  |              |                  |                         | Command/Reply Fields |  |  | Checksum   |            |
|   | <i>Sync1</i>   | <i>Sync2</i> | <i>Desc. Set</i> | <i>Payload Length</i>   | <i>Field Length</i>  | <i>Field Desc.</i>   | <i>Field Data</i>                      | <i>MSB</i> | <i>LSB</i> |
| <i>Command:<br/>Set to Idle</i>                                 | 0x75   | 0x65         | 0x01             | 0x02                    | 0x02                 | 0x02   |  | 0xE1       | 0xC7       |
| <i>Reply:<br/>ACK/NACK</i>                                      | 0x75   | 0x65         | 0x01             | 0x04                    | 0x04                 | 0xF1   | Command echo: 0x02<br>Error code: 0x00 | 0xD6       | 0x6C       |
| <i>Copy-Paste version of the command: "7565 0102 0202 E1C7"</i> |  |              |                  |                         |                      |  |  |            |            |

## 4.1.3 Get Device Information (0x01, 0x03)

| 4.1.3 Get Device Information (0x01, 0x03)                |   |                  |               |                  |  |             |  |          |      |
|--|---|------------------|---------------|------------------|--|-------------|--|----------|------|
| Description  | Get the device ID strings and firmware version. |                  |               |                  |  |             |  |          |      |
| Field Format   | Field Length                                    | Field Descriptor |               |                  | Field Data   |             |  |          |      |
| Command  | 0x02  | 0x03             |               |                  | N/A  |             |  |          |      |
| Reply Field 1:<br>ACK/NACK                               | 0x04  | 0xF1             |               |                  | U8 - echo the command byte<br>U8 - error code (0: ACK, non-zero: NACK) |             |  |          |      |
| Reply Field 2:<br>Array of<br>Descriptors                | 0x54  | 0x81             | Binary Offset | Description      | Data Type  | Uni s       |  |          |      |
|  |   |                  | 0             | Firmware version | U16  | N/A         |  |          |      |
|  |   |                  | 2             | Model Name       | String(16)   | N/A         |  |          |      |
|  |   |                  | 18            | Model Number     | String(16)   | N/A         |  |          |      |
|  |   |                  | 34            | Serial Number    | String(16)   | N/A         |  |          |      |
|  |   |                  | 50            | Reserved         | String (16)  | N/A         |  |          |      |
|  |   |                  | 66            | Options          | String (16)  | N/A         |  |          |      |
| Example  | MIP Packet Header                               |                  |               |                  | Command/Reply Fields   |             |  | Checksum |      |
|  | Sync1   | Sync2            | Desc. Set     | Payload Length   | Field Length   | Field Desc. | Field Data   | MSB      | LSB  |
| Command:<br>Get Device Info                              | 0x75  | 0x65             | 0x01          | 0x02             | 0x02   | 0x03        |  | 0xE2     | 0xC8 |
| Reply Field 1:<br>ACK/NACK                               | 0x75  | 0x65             | 0x01          | 0x58             | 0x04   | 0xF1        | Command echo:<br>0x03<br>Error code:<br>0x00   |          |      |
| Reply Field 2:<br>Device Info Field                      |   |                  |               |                  | 0x54   | 0x81        | FW Version: 0x05FE<br>" 3DM-GX5-45"<br>" 6232-4270"<br>" 6232-00122"<br>" "<br>" 5g, 150d/s" | 0x##     | 0x## |
| Copy-Paste version of the command: "7565 0102 0203 E2C8" |   |                  |               |                  |  |             |  |          |      |

## 4.1.4 Get Device Descriptor Sets (0x01, 0x04)

|   |  |                         |  |                       |                             |                    |   |                 |            |
|---|--|-------------------------|--|-----------------------|-----------------------------|--------------------|---|-----------------|------------|
| <b>Description</b>  | Get the set of descriptors that this device supports   |                         |  |                       |                             |                    |   |                 |            |
|   | Reply has two fields: “ACK/NACK” and “Descriptors”. The “Descriptors” field is an array of 16 bit values. The MSB specifies the descriptor set and the LSB specifies the descriptor. |                         |  |                       |                             |                    |   |                 |            |
| <b>Field Format</b>   | <i>Field Length</i>  | <i>Field Descriptor</i> | <i>Field Data</i>  |                       |                             |                    |   |                 |            |
| <i>Command</i>  | 0x02   | 0x04                    | N/A  |                       |                             |                    |   |                 |            |
| <i>Reply Field 1: ACK/NACK</i>                                  | 0x04   | 0xF1                    | U8 - echo the command byte<br>U8 - error code (0: ACK, non-zero: NACK) |                       |                             |                    |   |                 |            |
| <i>Reply Field 2: Array of Descriptors</i>                      | 2 x <Number of descriptors> + 2  | 0x82                    | <i>Binary Offset</i>   | <i>Description</i>    | <i>Data Type</i>            |                    |   |                 |            |
|   |  |                         | 0  | MSB: Descriptor Set   | U16                         |                    |   |                 |            |
|   |  |                         |  | LSB: Descriptor       |                             |                    |   |                 |            |
|   |  |                         | 2  | MSB: Descriptor Set   | U16                         |                    |   |                 |            |
| LSB: Descriptor   |  |                         |  |                       |                             |                    |   |                 |            |
| ...   |  |                         | etc.   | ...                   |                             |                    |   |                 |            |
| <b>Example</b>  | <b>MIP Packet Header</b>   |                         |  |                       | <b>Command/Reply Fields</b> |                    |   | <b>Checksum</b> |            |
|   | <i>Sync1</i>   | <i>Sync2</i>            | <i>Desc. Set</i>   | <i>Payload Length</i> | <i>Field Length</i>         | <i>Field Desc.</i> | <i>Field Data</i>   | <i>MSB</i>      | <i>LSB</i> |
| <i>Command: Get Device Info</i>                                 | 0x75   | 0x65                    | 0x01   | 0x02                  | 0x02                        | 0x04               |   | 0xE3            | 0xC9       |
| <i>Reply Field 1: ACK/NACK</i>                                  | 0x75   | 0x65                    | 0x01   | <(2 x n) + 6>         | 0x04                        | 0xF1               | Command echo: 0x01<br>Error code: 0x00                            |                 |            |
| <i>Reply Field 2: Array of Descriptors</i>                      |  |                         |  |                       | <(2 x n) + 2>               | 0x82               | 0x0101<br>0x0102<br>0x0103<br>0x0C01<br>0x0C02<br>nth descriptor: | 0x##            | 0x##       |
| <i>Copy-Paste version of the command: “7565 0102 0204 E3C9”</i> |  |                         |  |                       |                             |                    |   |                 |            |

## 4.1.5 Device Built-In Test (0x01, 0x05)

|   |  |                |                         |                          |  |                                       |                   |   |            |
|---|--|----------------|-------------------------|--------------------------|--|---------------------------------------|-------------------|---|------------|
| <b>Description</b>                        | Run the device Built-In Test (BIT). The Built-In Test command always returns a 32 bit value. A value of 0 means that all tests passed. A non-zero value indicates that not all tests passed. The failure flags are device dependent. The flags for the 3DM-GX5-45 are defined below. |                |                         |                          |  |                                       |                   |   |            |
|   | 3DM-GX5-45 BIT Error Flags:  |                |                         |                          |  |                                       |                   |   |            |
|   | <i>Byte</i>  | Byte 4 (MSB)   |                         | Byte 3                   |  | Byte 2                                |                   | Byte 1 (LSB)  |            |
|   | <i>Device</i>  | Kalman Filter  |                         | GNSS                     |  | Sensor Board                          |                   | Processor Board                                       |            |
|   | <i>Bit 1 (LSB)</i>   | Solution Fault |                         | Reserved                 |  | IMU Communication Fault               |                   | WDT Reset (Latching, Reset after first commanded BIT) |            |
|   | <i>Bit 2</i>   | Reserved       |                         | GPS Communications Fault |  | Magnetometer Fault (if applicable)    |                   | Reserved  |            |
|   | <i>Bit 3</i>   | Reserved       |                         | GPS Solution Fault       |  | Pressure Sensor Fault (if applicable) |                   | Reserved  |            |
|   | <i>Bit 4</i>   | Reserved       |                         | GPS Antenna Short Fault  |  | Reserved                              |                   | Reserved  |            |
|   | <i>Bit 5</i>   | Reserved       |                         | Reserved                 |  | Reserved                              |                   | Reserved  |            |
|   | <i>Bit 6</i>   | Reserved       |                         | Reserved                 |  | Reserved                              |                   | Reserved  |            |
| <i>Bit 7</i>                              | Reserved   |                | Reserved                |                          | Reserved   |                                       | Reserved          |   |            |
| <i>Bit 8 (MSB)</i>                        | Reserved   |                | Reserved                |                          | Reserved   |                                       | Reserved          |   |            |
| <b>Field Format</b>                       | <i>Field Length</i>  |                | <i>Field Descriptor</i> |                          | <i>Field Data</i>  |                                       |                   |   |            |
| <i>Command</i>                            | 0x02   |                | 0x05                    |                          | N/A  |                                       |                   |   |            |
| <i>Reply Field 1: ACK/NACK</i>            | 0x04   |                | 0xF1                    |                          | U8 - echo the command byte<br>U8 - error code (0: ACK, non-zero: NACK) |                                       |                   |   |            |
| <i>Reply Field 2: Array of BIT Errors</i> | 0x06   |                | 0x83                    |                          | U32 - BIT Error Flags  |                                       |                   |   |            |
| <b>Example</b>                            | MIP Packet Header  |                |                         |                          | Command/Reply Fields   |                                       |                   | Checksum  |            |
|   | <i>Sync1</i>   | <i>Sync2</i>   | <i>Desc. Set</i>        | <i>Payload Length</i>    | <i>Field Length</i>  | <i>Field Desc.</i>                    | <i>Field Data</i> | <i>MSB</i>  | <i>LSB</i> |
| <i>Command Built-In Test</i>              | 0x75   | 0x65           | 0x01                    | 0x02                     | 0x02   | 0x05                                  | N/A               | 0xE4  | 0xCA       |

|   |      |      |      |      |      |      |                                    |      |      |
|---|------|------|------|------|------|------|------------------------------------|------|------|
| <i>Reply Field 1:<br/>ACK/NACK</i>                              | 0x75 | 0x65 | 0x01 | 0x0A | 0x04 | 0xF1 | Echo cmd: 0x05<br>Error code: 0x00 |      |      |
| <i>Reply Field 2:<br/>BIT Error Flags</i>                       |      |      |      |      | 0x06 | 0x83 | BIT Error Flags:<br>0x00000000     | 0x68 | 0x7D |
| <i>Copy-Paste version of the command: "7565 0102 0205 E4CA"</i> |      |      |      |      |      |      |                                    |      |      |

### 4.1.6 Resume (0x01, 0x06)

|   |  |              |                         |                       |  |                    |  |            |            |
|---|--|--------------|-------------------------|-----------------------|--|--------------------|--|------------|------------|
| <b>Description</b>  | Place device back into the mode it was in before issuing the <a href="#">Set To Idle</a> command.<br>If the Set To Idle command was not issued, then the device is placed in default mode. Command has no parameters. Device responds with ACK if stream successfully enabled. |              |                         |                       |  |                    |  |            |            |
| <b>Field Format</b>   | <i>Field Length</i>  |              | <i>Field Descriptor</i> |                       | <i>Field Data</i>  |                    |  |            |            |
| <i>Command</i>  | 0x02   |              | 0x06                    |                       | N/A  |                    |  |            |            |
| <i>Reply:<br/>ACK/NACK</i>                                      | 0x04   |              | 0xF1                    |                       | U8 - echo the command byte<br>U8 - error code (0: ACK, non-zero: NACK) |                    |  |            |            |
| <b>Example</b>  | MIP Packet Header  |              |                         |                       | Command/Reply Fields   |                    |  | Checksum   |            |
|   | <i>Sync1</i>   | <i>Sync2</i> | <i>Desc. Set</i>        | <i>Payload Length</i> | <i>Field Length</i>  | <i>Field Desc.</i> | <i>Field Data</i>                      | <i>MSB</i> | <i>LSB</i> |
| <i>Command:<br/>Resume</i>                                      | 0x75   | 0x65         | 0x01                    | 0x02                  | 0x02   | 0x06               |  | 0xE5       | 0xCB       |
| <i>Reply:<br/>ACK/NACK</i>                                      | 0x75   | 0x65         | 0x01                    | 0x04                  | 0x04   | 0xF1               | Command echo: 0x01<br>Error code: 0x00 | 0xDA       | 0x74       |
| <i>Copy-Paste version of the command: "7565 0102 0206 E5CB"</i> |  |              |                         |                       |  |                    |  |            |            |

### 4.1.7 Get Extended Device Descriptor Sets (0x01, 0x07)

|                     |   |  |                         |  |                   |  |  |  |  |
|---------------------|---|--|-------------------------|--|-------------------|--|--|--|--|
| <b>Description</b>  | Get the extended set of descriptors that this device supports (descriptors in addition to the set returned by the <a href="#">Get Device Descriptors</a> command)<br><br>Reply has two fields: "ACK/NACK" and "Descriptors". The "Descriptors" field is an array of 16 bit values. The MSB specifies the descriptor set and the LSB specifies the descriptor. |  |                         |  |                   |  |  |  |  |
| <b>Notes</b>        | The <a href="#">Get Device Descriptor Sets</a> command is present on all devices supporting the MIP protocol. Extended descriptors are only supported on some devices. You may check for extended descriptors by searching for the 0x0107 descriptor in the list returned by the <a href="#">Get Device Descriptor Sets</a> command.                          |  |                         |  |                   |  |  |  |  |
| <b>Field Format</b> | <i>Field Length</i>   |  | <i>Field Descriptor</i> |  | <i>Field Data</i> |  |  |  |  |

|   |                                    |              |  |  |                             |                        |   |                 |            |
|---|------------------------------------|--------------|--|--|-----------------------------|------------------------|---|-----------------|------------|
| <i>Command</i>  | 0x02                               | 0x07         | N/A  |  |                             |                        |   |                 |            |
| <i>Reply Field 1:<br/>ACK/NACK</i>                              | 0x04                               | 0xF1         | U8 - echo the command byte<br>U8 - error code (0: ACK, non-zero: NACK) |  |                             |                        |   |                 |            |
| <i>Reply Field 2:<br/>Array of<br/>Descriptors</i>              | 2 x <Number of<br>descriptors> + 2 | 0x86         | <i>Binary<br/>Offset</i>   | <i>Description</i>                     | <i>Data Type</i>            |                        |   |                 |            |
|   |                                    |              | 0  | MSB: Descriptor Set<br>LSB: Descriptor | U16                         |                        |   |                 |            |
|   |                                    |              | 1  | MSB: Descriptor Set<br>LSB: Descriptor | U16                         |                        |   |                 |            |
|   |                                    |              | ...  | etc.                                   | ...                         |                        |   |                 |            |
| <b>Example</b>  | <b>MIP Packet Header</b>           |              |  |  | <b>Command/Reply Fields</b> |                        |   | <b>Checksum</b> |            |
|   | <i>Sync1</i>                       | <i>Sync2</i> | <i>Desc.<br/>Set</i>   | <i>Payload<br/>Length</i>              | <i>Field<br/>Length</i>     | <i>Field<br/>Desc.</i> | <i>Field Data</i>   | <i>MSB</i>      | <i>LSB</i> |
| <i>Command:<br/>Get Extended<br/>Descriptor Sets</i>            | 0x75                               | 0x65         | 0x01   | 0x02                                   | 0x02                        | 0x07                   |   | 0xE6            | 0xCC       |
| <i>Reply Field 1:<br/>ACK/NACK</i>                              | 0x75                               | 0x65         | 0x01   | <(2 x n)<br>+6>                        | 0x04                        | 0xF1                   | Command echo: 0x07<br>Error code: 0x00                            |                 |            |
| <i>Reply Field 2:<br/>Array of<br/>Descriptors</i>              |                                    |              |  |  | <(2 x n)<br>+ 2>            | 0x86                   | first extended<br>descriptor<br>...<br>nth extended<br>descriptor | 0x##            | 0x##       |
| <i>Copy-Paste version of the command: "7565 0102 0207 E6CC"</i> |                                    |              |  |  |                             |                        |   |                 |            |

#### 4.1.8 GPS Time Update (0x01, 0x72)

|                    |   |
|--------------------|---|
| <b>Description</b> | <p>This message updates the internal GPS Time as reported in the <a href="#">Filter Timestamp</a>.</p> <p>This command enables synchronization of IMU/AHRS Timestamps with an external GPS receiver. When combined with a PPS input applied to pin 7 of the I/O connector, the GPS Correlation Timestamp in the inertial data output is synchronized with the external GPS clock. It is recommended that this update command be sent once per second. See the <a href="#">GPS Correlation Timestamp</a> command for more information.</p> <p><i>Possible function selector values:</i></p> <ul style="list-style-type: none"> <li>0x01 - Apply new settings</li> <li>0x02 - Read back current settings</li> <li>0x06 - Apply new settings with no ACK/NACK reply</li> </ul> |
|                    |   |



## 4.1.8 GPS Time Update (0x01, 0x72)

| 4.1.8 GPS Time Update (0x01, 0x72)   |  |                  |                  |                       |  |                    |   |            |            |
|--|--|------------------|------------------|-----------------------|--|--------------------|---|------------|------------|
|  | <i>Possible field selector values:</i><br>0x01 - GPS Week Number<br>0x02 - GPS Seconds |                  |                  |                       |  |                    |   |            |            |
| Field Format   | Field Length   | Field Descriptor |                  |                       | Field Data   |                    |   |            |            |
| <i>Command</i>   | 0x08   | 0x72             |                  |                       | U8 - Function Selector<br>U8 - GPS Time Field Selector<br>U32 - New Time Value |                    |   |            |            |
| <i>Reply:<br/>ACK/NACK</i>   | 0x04   | 0xF1             |                  |                       | U8 - echo the command descriptor<br>U8 - error code (0: ACK, non-zero: NACK)   |                    |   |            |            |
| <i>Reply Field 2<br/>(function = 2,<br/>selector = 1)</i>                      | 0x06   | 0x84             |                  |                       | U32 - Current GPS Week Value   |                    |   |            |            |
| <i>Reply Field 2<br/>(function = 2,<br/>selector = 2)</i>                      | 0x06   | 0x85             |                  |                       | U32 - Current GPS Seconds Value  |                    |   |            |            |
| Example  | MIP Packet Header  |                  |                  |                       | Command/Reply Fields   |                    |   | Checksum   |            |
|  | <i>Sync1</i>   | <i>Sync2</i>     | <i>Desc. Set</i> | <i>Payload Length</i> | <i>Field Length</i>  | <i>Field Desc.</i> | <i>Field Data</i>   | <i>MSB</i> | <i>LSB</i> |
| <i>Command:<br/>GPS Time Update</i>  | 0x75   | 0x65             | 0x01             | 0x08                  | 0x08   | 0x72               | Fctn (Apply): 0x01<br>Field (Week): 0x00<br>Val: 0x00000698 | 0xFD       | 0x32       |
| <i>Reply :<br/>ACK/NACK</i>  | 0x75   | 0x65             | 0x01             | 0x04                  | 0x04   | 0xF1               | Cmd echo: 0x72<br>Error code: 0x00                          | 0x46       | 0x4C       |
| <i>Copy-Paste version of the command: "7565 0108 0872 0101 0000 0698 FD32"</i> |  |                  |                  |                       |  |                    |   |            |            |

## 4.1.9 Device Reset (0x01, 0x7E)

|   |  |              |                         |                       |  |                    |  |            |            |
|---|--|--------------|-------------------------|-----------------------|--|--------------------|--|------------|------------|
| <b>Description</b>  | Resets the device.<br>Device responds with ACK if it recognizes the command and then immediately resets. |              |                         |                       |  |                    |  |            |            |
| <b>Field Format</b>   | <i>Field Length</i>  |              | <i>Field Descriptor</i> |                       | <i>Field Data</i>  |                    |  |            |            |
| <i>Command</i>  | 0x02   |              | 0x7E                    |                       | N/A  |                    |  |            |            |
| <i>Reply Field 1: ACK/NACK</i>                                  | 0x04   |              | 0xF1                    |                       | U8 - Echo the command byte<br>U8 - Error code (0: ACK, non-zero: NACK) |                    |  |            |            |
| <b>Example</b>  | MIP Packet Header  |              |                         |                       | Command/Reply Fields   |                    |  | Checksum   |            |
|   | <i>Sync1</i>   | <i>Sync2</i> | <i>Desc. Set</i>        | <i>Payload Length</i> | <i>Field Length</i>  | <i>Field Desc.</i> | <i>Field Data</i>                      | <i>MSB</i> | <i>LSB</i> |
| <i>Command: Ping</i>  | 0x75   | 0x65         | 0x01                    | 0x02                  | 0x02   | 0x7E               |  | 0x5D       | 0x43       |
| <i>Reply Field 1: ACK/NACK</i>                                  | 0x75   | 0x65         | 0x01                    | 0x04                  | 0x04   | 0xF1               | Command echo: 0x7E<br>Error code: 0x00 | 0x52       | 0x64       |
| <i>Copy-Paste version of the command: "7565 0102 027E 5D43"</i> |  |              |                         |                       |  |                    |  |            |            |

## 4.2 3DM Commands

The 3DM command set is common to the LORD Sensing Inertial sensors that support the MIP packet protocol. Because of the unified set of commands, it is easy to migrate code from one inertial sensor to another.

### 4.2.1 Poll IMU Data (0x0C, 0x01)

|  |  |              |                         |                       |   |                    |  |            |            |
|--|--|--------------|-------------------------|-----------------------|---|--------------------|--|------------|------------|
| <b>Description</b>   | Poll the device for an IMU message with the specified format   |              |                         |                       |   |                    |  |            |            |
|  | <p>This function polls for an IMU message using the provided format. The resulting message will maintain the order of descriptors sent in the command and any unrecognized descriptors are ignored. If the format is not provided, the device will attempt to use the stored format (set with the <a href="#">Set IMU Message Format</a> command.) If no format is provided and there is no stored format, the device will respond with a NACK. The reply packet contains an ACK/NACK field. The polled data packet is sent separately as an IMU Data packet.</p> <p>Possible Option Selector Values:</p> <p>0x00 - Normal ACK/NACK Reply.<br/>0x01 - Suppress the ACK/NACK reply.</p> |              |                         |                       |   |                    |  |            |            |
| <b>Field Format</b>  | <i>Field Length</i>  |              | <i>Field Descriptor</i> |                       | <i>Field Data</i>   |                    |  |            |            |
| <i>Command</i>   | 4 + 3*N  |              | 0x01                    |                       | U8 - Option Selector<br>U8 - Number of Descriptors (N)<br>N*(U8 - Descriptor, U16 Reserved) |                    |  |            |            |
| <i>Reply:<br/>ACK/ NACK</i>                                  | 0x04   |              | 0xF1                    |                       | U8 - echo the command byte<br>U8 - error code (0: ACK, non-zero: NACK)                      |                    |  |            |            |
| <b>Example</b>   | MIP Packet Header  |              |                         |                       | Command/Reply Fields  |                    |  | Checksum   |            |
|  | <i>Sync1</i>   | <i>Sync2</i> | <i>Desc. Set</i>        | <i>Payload Length</i> | <i>Field Length</i>   | <i>Field Desc.</i> | <i>Field Data</i>  | <i>MSB</i> | <i>LSB</i> |
| <i>Command:<br/>Poll IMU data<br/>(use stored format)</i>    | 0x75   | 0x65         | 0x0C                    | 0x04                  | 0x04  | 0x01               | Option: 0x00<br>Desc count: 0x00   | 0xEF       | 0xDA       |
| <i>Command:<br/>Poll IMU data<br/>(use specified format)</i> | 0x75   | 0x65         | 0x0C                    | 0x0A                  | 0x0A  | 0x01               | Option: 0x00<br>Desc count: 0x02<br>1st Descriptor: 0x04<br>Reserved: 0x0000<br>2nd Descriptor: 0x05<br>Reserved: 0x0000 | 0x06       | 0x27       |

|   |      |      |      |      |      |      |  |      |      |
|---|------|------|------|------|------|------|--|------|------|
| <i>Reply:</i><br><i>ACK/NACK</i>  | 0x75 | 0x65 | 0x0C | 0x04 | 0x04 | 0xF1 | Command echo: 0x01<br>Error code: 0x00 | 0xE0 | 0xAC |
| <i>Copy-Paste versions of the commands:</i><br><i>Stored format: "7565 0C04 0401 0000 EFDA"</i><br><i>Specified format: "7565 0C0A 0A01 0002 0400 0005 0000 0627"</i> |      |      |      |      |      |      |  |      |      |

## 4.2.2 Poll GNSS Data (0x0C, 0x02)

|   |   |                         |                  |                       |   |                    |  |            |            |
|---|---|-------------------------|------------------|-----------------------|---|--------------------|--|------------|------------|
| <b>Description</b>  | Poll the device for a GNSS message with the specified format  |                         |                  |                       |   |                    |  |            |            |
|   | <p>This function polls for a GNSS message using the provided format. The resulting message will maintain the order of descriptors sent in the command and any unrecognized descriptors are ignored. If the format is not provided, the device will attempt to use the stored format (set with the <a href="#">Set GNSS Message Format</a> command.) If no format is provided and there is no stored format, the device will respond with a NACK. The reply packet contains an ACK/NACK field. The polled data packet is sent separately as a GNSS Data packet.</p> <p>Possible Option Selector Values:</p> <p>0x00 - Normal ACK/NACK Reply.<br/>0x01 - Suppress the ACK/NACK reply.</p> |                         |                  |                       |   |                    |  |            |            |
| <b>Field Format</b>   | <i>Field Length</i>   | <i>Field Descriptor</i> |                  |                       | <i>Field Data</i>   |                    |  |            |            |
| <i>Command</i>  | 4 + 3*N   | 0x02                    |                  |                       | U8 - Option Selector<br>U8 - Number of Descriptors (N)<br>N*(U8 - Descriptor, U16 Reserved) |                    |  |            |            |
| <i>Reply:</i><br><i>ACK/ NACK</i>                               | 0x04  | 0xF1                    |                  |                       | U8 - echo the command byte<br>U8 - error code (0: ACK, non-zero: NACK)                      |                    |  |            |            |
| <b>Example</b>  | MIP Packet Header   |                         |                  |                       | Command/Reply Fields  |                    |  | Checksum   |            |
|   | <i>Sync1</i>  | <i>Sync2</i>            | <i>Desc. Set</i> | <i>Payload Length</i> | <i>Field Length</i>   | <i>Field Desc.</i> | <i>Field Data</i>  | <i>MSB</i> | <i>LSB</i> |
| <i>Command:</i><br><i>Poll GNSS data (use stored format)</i>    | 0x75  | 0x65                    | 0x0C             | 0x04                  | 0x04  | 0x02               | Option: 0x00<br>Desc count: 0x00   | 0xF0       | 0xDD       |
| <i>Command:</i><br><i>Poll GNSS data (use specified format)</i> | 0x75  | 0x65                    | 0x0C             | 0x0A                  | 0x0A  | 0x02               | Option: 0x00<br>Desc count: 0x02<br>1st Descriptor: 0x03<br>Reserved: 0x0000<br>2nd Descriptor: 0x05<br>Reserved: 0x0000 | 0x06       | 0x2A       |

|   |      |      |      |      |      |      |  |      |      |
|---|------|------|------|------|------|------|--|------|------|
| <i>Reply:<br/>ACK/NACK<br/>(Data packet is<br/>sent separately<br/>if ACK)</i>  | 0x75 | 0x65 | 0x0C | 0x04 | 0x04 | 0xF1 | Command echo: 0x02<br>Error code: 0x00 | 0xE1 | 0xAE |
| <i>Copy-Paste versions of the commands:<br/>         Stored format: "7565 0C04 0402 0000 F0DD"<br/>         Specified format: "7565 0C0A 0A02 0002 0300 0005 0000 062A"</i> |      |      |      |      |      |      |  |      |      |

## 4.2.3 Poll Estimation Filter Data (0x0C, 0x03)

|   |  |                         |                  |                       |   |                    |  |            |            |
|---|--|-------------------------|------------------|-----------------------|---|--------------------|--|------------|------------|
| <b>Description</b>  | Poll the device for an Estimation Filter message with the specified format   |                         |                  |                       |   |                    |  |            |            |
|   | <p>This function polls for an Estimation Filter message using the provided format. The resulting message will maintain the order of descriptors sent in the command and any unrecognized descriptors are ignored. If the format is not provided, the device will attempt to use the stored format (set with the <a href="#">Set Estimation Filter Message Format</a> command.) If no format is provided and there is no stored format, the device will respond with a NACK. The reply packet contains an ACK/NACK field. The polled data packet is sent separately as an Estimation Filter Data packet.</p> <p>Possible Option Selector Values:</p> <p>0x00 - Normal ACK/NACK Reply.<br/>0x01 - Suppress the ACK/NACK reply.</p> |                         |                  |                       |   |                    |  |            |            |
| <b>Field Format</b>   | <i>Field Length</i>  | <i>Field Descriptor</i> |                  |                       | <i>Field Data</i>   |                    |  |            |            |
| <i>Command</i>  | 4 + 3*N  | 0x03                    |                  |                       | U8 - Option Selector<br>U8 - Number of Descriptors (N)<br>N*(U8 - Descriptor, U16 Reserved) |                    |  |            |            |
| <i>Reply:<br/>ACK/ NACK</i>   | 0x04   | 0xF1                    |                  |                       | U8 - echo the command byte<br>U8 - error code (0: ACK, non-zero: NACK)                      |                    |  |            |            |
| <b>Example</b>  | MIP Packet Header  |                         |                  |                       | Command/Reply Fields  |                    |  | Checksum   |            |
|   | <i>Sync1</i>   | <i>Sync2</i>            | <i>Desc. Set</i> | <i>Payload Length</i> | <i>Field Length</i>   | <i>Field Desc.</i> | <i>Field Data</i>  | <i>MSB</i> | <i>LSB</i> |
| <i>Command:<br/>Poll IMU data<br/>(use stored format)</i>                                 | 0x75   | 0x65                    | 0x0C             | 0x04                  | 0x04  | 0x03               | Option: 0x00<br>Desc count: 0x00   | 0xF1       | 0xE0       |
| <i>Command:<br/>Poll IMU data<br/>(use specified format)</i>                              | 0x75   | 0x65                    | 0x0C             | 0x0A                  | 0x0A  | 0x03               | Option: 0x00<br>Desc count: 0x02<br>1st Descriptor: 0x01<br>Reserved: 0x0000<br>2nd Descriptor: 0x02<br>Reserved: 0x0000 | 0x02       | 0x1E       |
| <i>Reply:<br/>ACK/NACK<br/>(Data packet is sent separately if ACK)</i>                    | 0x75   | 0x65                    | 0x0C             | 0x04                  | 0x04  | 0xF1               | Command echo: 0x03<br>Error code: 0x00   | 0xE2       | 0xB0       |
| <i>Copy-Paste versions of the commands:<br/>Stored format: "7565 0C04 0403 0000 F1E0"</i> |  |                         |                  |                       |   |                    |  |            |            |

Specified format: "7565 0C0A 0A03 0002 0100 0002 0000 021E"

#### 4.2.4 Get IMU Data Base Rate (0x0C, 0x06)

|   |   |              |                         |                       |  |                    |  |            |            |
|---|---|--------------|-------------------------|-----------------------|--|--------------------|--|------------|------------|
| <b>Description</b>  | Get the base rate for the IMU data in Hz.<br><br>Returns the value used for data rate calculations. See the <a href="#">IMU Message Format</a> command. |              |                         |                       |  |                    |  |            |            |
| <b>Field Format</b>   | <i>Field Length</i>   |              | <i>Field Descriptor</i> |                       | <i>Field Data</i>  |                    |  |            |            |
| <i>Command</i>  | 0x02  |              | 0x06                    |                       | None   |                    |  |            |            |
| <i>Reply Field 1: ACK/NACK</i>                                  | 0x04  |              | 0xF1                    |                       | U8 - echo the command byte<br>U8 - error code (0: ACK, non-zero: NACK) |                    |  |            |            |
| <i>Reply Field 2: IMU Base Rate</i>                             | 0x04  |              | 0x83                    |                       | U16 - IMU data base rate (Hz)  |                    |  |            |            |
| <b>Example</b>  | MIP Packet Header   |              |                         |                       | Command/Reply Fields   |                    |  | Checksum   |            |
|   | <i>Sync1</i>  | <i>Sync2</i> | <i>Desc. Set</i>        | <i>Payload Length</i> | <i>Field Length</i>  | <i>Field Desc.</i> | <i>Field Data</i>                      | <i>MSB</i> | <i>LSB</i> |
| <i>Command: Get IMU Base Rate</i>                               | 0x75  | 0x65         | 0x0C                    | 0x02                  | 0x02   | 0x06               |  | 0xF0       | 0xF7       |
| <i>Reply Field 1: ACK/NACK</i>                                  | 0x75  | 0x65         | 0x0C                    | 0x08                  | 0x04   | 0xF1               | Command echo: 0x06<br>Error code: 0x00 |            |            |
| <i>Reply Field 2: IMU Base Rate</i>                             |   |              |                         |                       | 0x04   | 0x83               | Base rate (Hz):<br>0x00064             | 0xD4       | 0x6B       |
| <i>Copy-Paste version of the command: "7565 0C02 0206 F0F7"</i> |   |              |                         |                       |  |                    |  |            |            |

## 4.2.5 Get GNSS Data Base Rate (0x0C, 0x07)

|   |   |                         |                  |                       |  |                    |  |            |            |
|---|---|-------------------------|------------------|-----------------------|--|--------------------|--|------------|------------|
| <b>Description</b>  | Get the base rate for the GNSS data in Hz.<br>Returns the value used for data rate calculations. See the <a href="#">GNSS Message Format</a> command. |                         |                  |                       |  |                    |  |            |            |
| <b>Field Format</b>   | <i>Field Length</i>   | <i>Field Descriptor</i> |                  |                       | <i>Field Data</i>  |                    |  |            |            |
| <i>Command</i>  | 0x02  | 0x06                    |                  |                       | None   |                    |  |            |            |
| <i>Reply Field 1: ACK/NACK</i>                                  | 0x04  | 0xF1                    |                  |                       | U8 - Echo the command byte<br>U8 - Error code (0: ACK, non-zero: NACK) |                    |  |            |            |
| <i>Reply Field 2: IMU Base Rate</i>                             | 0x04  | 0x84                    |                  |                       | U16 - GNSS data base rate (Hz)   |                    |  |            |            |
| <b>Example</b>  | MIP Packet Header   |                         |                  |                       | Command/Reply Fields   |                    |  | Checksum   |            |
|   | <i>Sync1</i>  | <i>Sync2</i>            | <i>Desc. Set</i> | <i>Payload Length</i> | <i>Field Length</i>  | <i>Field Desc.</i> | <i>Field Data</i>                      | <i>MSB</i> | <i>LSB</i> |
| <i>Command: Get IMU Base Rate</i>                               | 0x75  | 0x65                    | 0x0C             | 0x02                  | 0x02   | 0x07               |  | 0xF1       | 0xF8       |
| <i>Reply Field 1: ACK/NACK</i>                                  | 0x75  | 0x65                    | 0x0C             | 0x08                  | 0x04   | 0xF1               | Command echo: 0x07<br>Error code: 0x00 |            |            |
| <i>Reply Field 2: GNSS Base Rate</i>                            |   |                         |                  |                       | 0x04   | 0x84               | Base rate (Hz):<br>0x0x0004            | 0x76       | 0x14       |
| <i>Copy-Paste version of the command: "7565 0C02 0207 F1F8"</i> |   |                         |                  |                       |  |                    |  |            |            |



## 4.2.6 Get Estimation Filter Data Base Rate (0x0C, 0x0B)

|   |   |              |                         |                       |  |                    |  |            |            |
|---|---|--------------|-------------------------|-----------------------|--|--------------------|--|------------|------------|
| <b>Description</b>  | Get the base rate for the Estimation Filter data in Hz.<br>Returns the value used for data rate calculations. See the <a href="#">Estimation Filter Message Format</a> command. |              |                         |                       |  |                    |  |            |            |
| <b>Field Format</b>   | <i>Field Length</i>   |              | <i>Field Descriptor</i> |                       | <i>Field Data</i>  |                    |  |            |            |
| <i>Command</i>  | 0x02  |              | 0x0B                    |                       | None   |                    |  |            |            |
| <i>Reply Field 1: ACK/NACK</i>                                  | 0x04  |              | 0xF1                    |                       | U8 - Echo the command byte<br>U8 - Error code (0: ACK, non-zero: NACK) |                    |  |            |            |
| <i>Reply Field 2: IMU Base Rate</i>                             | 0x04  |              | 0x8A                    |                       | U16 - Estimation Filter data base rate (Hz)                            |                    |  |            |            |
| <b>Example</b>  | MIP Packet Header   |              |                         |                       | Command/Reply Fields   |                    |  | Checksum   |            |
|   | <i>Sync1</i>  | <i>Sync2</i> | <i>Desc. Set</i>        | <i>Payload Length</i> | <i>Field Length</i>  | <i>Field Desc.</i> | <i>Field Data</i>                      | <i>MSB</i> | <i>LSB</i> |
| <i>Command: Get IMU Base Rate</i>                               | 0x75  | 0x65         | 0x0C                    | 0x02                  | 0x02   | 0x0B               |  | 0xF5       | 0xFC       |
| <i>Reply Field 1: ACK/NACK</i>                                  | 0x75  | 0x65         | 0x0C                    | 0x08                  | 0x04   | 0xF1               | Command echo: 0x0B<br>Error code: 0x00 |            |            |
| <i>Reply Field 2: Estimation Filter Base Rate</i>               |   |              |                         |                       | 0x04   | 0x8A               | Base rate (Hz):<br>0x0x0064            | 0xE0       | 0x9E       |
| <i>Copy-Paste version of the command: "7565 0C02 020B F5FC"</i> |   |              |                         |                       |  |                    |  |            |            |

## 4.2.7 IMU Message Format (0x0C, 0x08)

### Description

Set, read, or save the format of the IMU message packet. This command sets the format for the IMU data packet when in standard mode. The resulting data messages will maintain the order of descriptors sent in the command. The command has a function selector and a descriptor array as parameters.

Possible Function Selector Values:

- 0x01 - Use new settings
- 0x02 - Read back current settings.
- 0x03 - Save current settings as startup settings
- 0x04 - Load saved startup settings
- 0x05 - Reset to factory default settings

The rate decimation field is calculated as follows for IMU messages:

$$\text{Rate Decimation} = \text{IMU Base Rate} / \text{Desired Data Rate}$$

You should always retrieve the Base Rate from the [Get IMU Data Base Rate](#) command for computing the desired rate decimation. Base rates vary from device to device. The IMU base rate for the 3DM-GX5 is 500.

The device checks that all descriptors are valid prior to executing this command. If any of the descriptors are invalid for the IMU descriptor set, a NACK will be returned and the message format will be unchanged. The descriptor array only needs to be provided if the function selector is = 1 (Use new settings). For all other functions it may be empty (Number of Descriptors = 0).

Figure 1 -

| Field Format                           | Field Length      | Field Descriptor | Field Data   |                       |                      |                    |                                    |            |            |
|--|-------------------|------------------|--|-----------------------|----------------------|--------------------|------------------------------------|------------|------------|
| <i>Command</i>                         | 4 + 3*N           | 0x08             | U8 - Function Selector<br>U8 - Number of Descriptors (N)<br>N*(U8 - Descriptor, U16 - Rate Decimation) |                       |                      |                    |                                    |            |            |
| <i>Reply Field 1:<br/>ACK/ NACK</i>    | 0x04              | 0xF1             | U8 - echo the command byte<br>U8 - error code (0: ACK, non-zero: NACK)                                 |                       |                      |                    |                                    |            |            |
| <i>Reply Field 2:<br/>Function = 2</i> | 3 + 3*N           | 0x80             | U8 - Number of Descriptors (N)<br>N*(U8 - Descriptor, U16 - Rate Decimation)                           |                       |                      |                    |                                    |            |            |
| Example                                | MIP Packet Header |                  |  |                       | Command/Reply Fields |                    |                                    | Checksum   |            |
|  | <i>Sync1</i>      | <i>Sync2</i>     | <i>Desc. Set</i>   | <i>Payload Length</i> | <i>Field Length</i>  | <i>Field Desc.</i> | <i>Field Data</i>                  | <i>MSB</i> | <i>LSB</i> |
| <i>Command:<br/>IMU Message</i>        | 0x75              | 0x65             | 0x0C   | 0x0A                  | 0x0A                 | 0x08               | Function: 0x01<br>Desc count: 0x02 | 0x22       | 0xA0       |

|   |      |      |      |      |      |      |  |      |      |
|---|------|------|------|------|------|------|--|------|------|
| <i>Format (use new settings)</i>  |      |      |      |      |      |      | 1st Descriptor: 0x04<br>Rate Dec: 0x000A<br>2nd Descriptor: 0x05<br>Rate Dec: 0x000A                     |      |      |
| <i>Reply Field:<br/>ACK/NACK</i>  | 0x75 | 0x65 | 0x0C | 0x04 | 0x04 | 0xF1 | Echo cmd: 0x01<br>Error code: 0x00   | 0xE7 | 0xBA |
| <i>Command: IMU<br/>Message Format<br/>(read back current settings)</i>   | 0x75 | 0x65 | 0x0C | 0x04 | 0x04 | 0x08 | Function: 0x02<br>Desc count: 0x00   | 0xF8 | 0xF3 |
| <i>Reply Field 1:<br/>ACK/NACK</i>  | 0x75 | 0x65 | 0x0C | 0x0D | 0x04 | 0xF1 | Echo cmd: 0x08<br>Error code: 0x00   |      |      |
| <i>Reply Field 2:<br/>Current IMU<br/>Message Format</i>  |      |      |      |      | 0x09 | 0x80 | Desc count: 0x02<br>1st Descriptor: 0x03<br>Rate Dec: 0x000A<br>2nd Descriptor: 0x04<br>Rate Dec: 0x000A | 0x98 | 0x0F |
| <p><i>Copy-Paste version of the commands:</i><br/> <i>Use New Settings: "7565 0C0A 0A08 0102 0400 0A05 000A 22A0"</i><br/> <i>Read Current Settings: "7565 0C04 0408 0200 F8F3"</i></p> |      |      |      |      |      |      |  |      |      |

## 4.2.8 GNSS Message Format (0x0C, 0x09)

|  |  |                     |  |                       |                      |                    |                   |            |            |
|--|--|---------------------|--|-----------------------|----------------------|--------------------|-------------------|------------|------------|
| <b>Description</b>                     | <p>Set, read, or save the format of the GNSS message packet. This function sets the format for the GNSS MIP data packet when in standard mode. The resulting message will maintain the order of descriptors sent in the command. The command has a function selector and a descriptor array as parameters.</p> <p>Possible function selector values:</p> <ul style="list-style-type: none"> <li>0x01 - Use new settings</li> <li>0x02 - Read back current settings.</li> <li>0x03 - Save current settings as startup settings</li> <li>0x04 - Load saved startup settings</li> <li>0x05 - Reset to factory default settings</li> </ul> <p>The rate decimation field is calculated as follows for GNSS messages:</p> $\text{Rate Decimation} = \text{GNSS Base Rate} / \text{Desired Data Rate}$ <p>You should always retrieve the Base Rate from the <a href="#">Get GNSS Data Base Rate</a> command for computing the desired rate decimation. Base rates vary from device to device. The GNSS base rate for the 3DM-GX5 is 4.</p> <p>The device checks that all descriptors are valid prior to executing this command. If any of the descriptors are invalid for the GNSS data descriptor set, a NACK will be returned and the message format will be unchanged. The descriptor array only needs to be provided if the function selector is = 1 (Use new settings). For all other functions it may be empty (Number of Descriptors = 0).</p> |                     |  |                       |                      |                    |                   |            |            |
|  | <b>Field Format</b>  | <i>Field Length</i> | <i>Field Descriptor</i>  | <i>Field Data</i>     |                      |                    |                   |            |            |
| <i>Command</i>                         | 4 + 3*N  | 0x09                | U8 - Function Selector<br>U8 - Number of Descriptors (N)<br>N*(U8 - Descriptor, U16 - Rate Decimation) |                       |                      |                    |                   |            |            |
| <i>Reply Field 1:<br/>ACK/ NACK</i>    | 0x04   | 0xF1                | U8 - echo the command descriptor<br>U8 - error code (0: ACK, non-zero: NACK)                           |                       |                      |                    |                   |            |            |
| <i>Reply Field 2:<br/>Function = 2</i> | 3 + 3*N  | 0x81                | U8 - Number of Descriptors (N)<br>N*(U8 - Descriptor, U16 - Rate Decimation)                           |                       |                      |                    |                   |            |            |
| <b>Examples</b>                        | MIP Packet Header  |                     |  |                       | Command/Reply Fields |                    |                   | Checksum   |            |
|  | <i>Sync1</i>   | <i>Sync2</i>        | <i>Desc. Set</i>   | <i>Payload Length</i> | <i>Field Length</i>  | <i>Field Desc.</i> | <i>Field Data</i> | <i>MSB</i> | <i>LSB</i> |
| <i>Command:</i>                        | 0x75   | 0x65                | 0x0C   | 0x0A                  | 0x0A                 | 0x09               | Function: 0x01    | 0x16       | 0x85       |

|   |      |      |      |      |      |      |  |      |      |
|---|------|------|------|------|------|------|--|------|------|
| <i>GNSS Message Format (use new settings)</i>   |      |      |      |      |      |      | Desc count: 0x02<br>1st Descriptor: 0x03<br>Data Rate: 0x0004<br>2nd Descriptor: 0x05<br>Data Rate: 0x0004 |      |      |
| <i>Reply Field : ACK/NACK</i>   | 0x75 | 0x65 | 0x0C | 0x04 | 0x04 | 0xF1 | Echo cmd: 0x09<br>Error code: 0x00   | 0xE8 | 0xBC |
| <i>Command: GNSS Message Format (read back current settings)</i>  | 0x75 | 0x65 | 0x0C | 0x04 | 0x04 | 0x09 | Function: 0x02<br>Desc count: 0x00   | 0xF9 | 0xF3 |
| <i>Reply Field 1: ACK/NACK</i>  | 0x75 | 0x65 | 0x0C | 0x0D | 0x04 | 0xF1 | Echo cmd: 0x09<br>Error code: 0x00   |      |      |
| <i>Reply Field 2: Current GNSS Message Format</i>   |      |      |      |      | 0x09 | 0x81 | Desc count: 0x02<br>1st Descriptor: 0x03<br>Data Rate: 0x0004<br>2nd Descriptor: 0x05<br>Data Rate: 0x0004 | 0x8D | 0xFE |
| <p><i>Copy-Paste version of the commands:</i><br/> <i>Use New Settings: "7565 0C0A 0A09 0102 0300 0405 0004 1685"</i><br/> <i>Read Current Settings: "7565 0C04 0409 0200 F9F6"</i></p> |      |      |      |      |      |      |  |      |      |

## 4.2.9 Estimation Filter Message Format (0x0C, 0x0A)

|  |   |                     |  |                       |                      |                    |                   |            |            |
|--|---|---------------------|--|-----------------------|----------------------|--------------------|-------------------|------------|------------|
| <b>Description</b>                     | <p>Set, read, or save the format of the Estimation Filter message packet. This function sets the format for the Estimation Filter data packet when in standard mode. The resulting message will maintain the order of descriptors sent in the command. The command has a function selector and a descriptor array as parameters.</p> <p>Possible function selector values:</p> <ul style="list-style-type: none"> <li>0x01 - Use new settings</li> <li>0x02 - Read back current settings.</li> <li>0x03 - Save current settings as startup settings</li> <li>0x04 - Load saved startup settings</li> <li>0x05 - Reset to factory default settings</li> </ul> <p>The rate decimation field is calculated as follows for Estimation Filter messages:</p> $\text{Rate Decimation} = \text{EF Base Rate} / \text{Desired Data Rate}$ <p>You should always retrieve the Base Rate from the <a href="#">Get Estimation Filter Data Base Rate</a> command for computing the desired rate decimation. Base rates vary from device to device. The EF base rate for the 3DM-GX5 is 500.</p> <p>The device checks that all descriptors are valid prior to executing this command. If any of the descriptors are invalid for the Estimation Filter data descriptor set, a NACK will be returned and the message format will be unchanged. The descriptor array only needs to be provided if the function selector is = 1 (Use new settings). For all other functions it may be empty (Number of Descriptors = 0).</p> |                     |  |                       |                      |                    |                   |            |            |
|  | <b>Field Format</b>   | <i>Field Length</i> | <i>Field Descriptor</i>  | <i>Field Data</i>     |                      |                    |                   |            |            |
| <i>Command</i>                         | 4 + 3*N   | 0x0A                | U8 - Function Selector<br>U8 - Number of Descriptors (N)<br>N*(U8 - Descriptor, U16 - Rate Decimation) |                       |                      |                    |                   |            |            |
| <i>Reply Field 1:<br/>ACK/ NACK</i>    | 0x04  | 0xF1                | U8 - echo the command descriptor<br>U8 - error code (0: ACK, non-zero: NACK)                           |                       |                      |                    |                   |            |            |
| <i>Reply Field 2:<br/>Function = 2</i> | 3 + 3*N   | 0x82                | U8 - Number of Descriptors (N)<br>N*(U8 - Descriptor, U16 - Rate Decimation)                           |                       |                      |                    |                   |            |            |
| <b>Examples</b>                        | MIP Packet Header   |                     |  |                       | Command/Reply Fields |                    |                   | Checksum   |            |
|  | <i>Sync1</i>  | <i>Sync2</i>        | <i>Desc. Set</i>   | <i>Payload Length</i> | <i>Field Length</i>  | <i>Field Desc.</i> | <i>Field Data</i> | <i>MSB</i> | <i>LSB</i> |
| <i>Command:</i>                        | 0x75  | 0x65                | 0x0C   | 0x0A                  | 0x0A                 | 0x0A               | Function: 0x01    | 0x0C       | 0x6A       |

|   |      |      |      |      |      |      |  |      |      |
|---|------|------|------|------|------|------|--|------|------|
| <i>Estimation Filter<br/>Message Format<br/>(use new<br/>settings)</i>  |      |      |      |      |      |      | Desc count: 0x02<br>1st Descriptor: 0x01<br>Data Rate: 0x0001<br>2nd Descriptor: 0x02<br>Data Rate: 0x0001 |      |      |
| <i>Reply Field:<br/>ACK/NACK</i>  | 0x75 | 0x65 | 0x0C | 0x04 | 0x04 | 0xF1 | Echo cmd: 0x0A<br>Error code: 0x00   | 0xE9 | 0xBE |
| <i>Command:<br/>Estimation Filter<br/>Message Format<br/>(read back<br/>current settings)</i>   | 0x75 | 0x65 | 0x0C | 0x04 | 0x04 | 0x0A | Function: 0x02<br>Desc count: 0x00   | 0xFA | 0xF9 |
| <i>Reply Field 1:<br/>ACK/NACK</i>  | 0x75 | 0x65 | 0x0C | 0x0D | 0x04 | 0xF1 | Echo cmd: 0x0A<br>Error code: 0x00   |      |      |
| <i>Reply Field 2:<br/>Current<br/>Message Format</i>  |      |      |      |      | 0x09 | 0x82 | Desc count: 0x02<br>1st Descriptor: 0x01<br>Data Rate: 0x0001<br>2nd Descriptor: 0x02<br>Data Rate: 0x0001 | 0x84 | 0xED |
| <p><i>Copy-Paste version of the commands:</i><br/> Use New Settings: "7565 0C0A 0A0A 0102 0100 0102 0001 0C6A"<br/> Read Current Settings: "7565 0C04 040A 0200 FAF9"</p> |      |      |      |      |      |      |  |      |      |

## 4.2.10 Enable/Disable Continuous Data Stream (0x0C, 0x11)

|  |  |                         |  |
|--|--|-------------------------|--|
| <b>Description</b>                       | <p>Control the streaming of IMU, GNSS and Estimation Filter data. If disabled, the data from the selected device is not continuously transmitted. Upon enabling, the most current data will be transmitted (i.e. no stale data is transmitted.) The default for the device is all streams enabled. For all functions except 0x01 (use new setting), the new enable flag value is ignored.</p> <p>Possible function selector values:</p> <ul style="list-style-type: none"> <li>0x01 - Apply new settings</li> <li>0x02 - Read back current settings</li> <li>0x03 - Save current settings as startup settings</li> <li>0x04 - Load saved startup settings</li> <li>0x05 - Load factory default settings</li> </ul> <p>The device selector can be:</p> <ul style="list-style-type: none"> <li>0x01 - IMU</li> <li>0x02 - GNSS</li> <li>0x03 - Estimation Filter</li> </ul> <p>The enable flag can be either:</p> <ul style="list-style-type: none"> <li>0x00 - Disable the selected stream</li> <li>0x01 - Enable the selected stream (<i>default</i>)</li> </ul> |                         |  |
| <b>Field Format</b>                      | <i>Field Length</i>  | <i>Field Descriptor</i> | <i>Field Data</i>  |
| <i>Command</i>                           | 0x05   | 0x11                    | U8 - Function Selector<br>U8 - Device Selector<br>U8 - New Enable Flag       |
| <i>Reply Field 1:<br/>ACK/NACK</i>       | 0x04   | 0xF1                    | U8 - Echo the command descriptor<br>U8 - Error code (0: ACK, non-zero: NACK) |
| <i>Reply Field 2:<br/>(function = 2)</i> | 0x04   | 0x85                    | U8 - Device Selector<br>U8 - Current Device Enable Flag                      |



| Examples  | MIP Packet Header |              |                  |                       | Command/Reply Fields |                    |   | Checksum   |            |
|---|-------------------|--------------|------------------|-----------------------|----------------------|--------------------|---|------------|------------|
|   | <i>Sync1</i>      | <i>Sync2</i> | <i>Desc. Set</i> | <i>Payload Length</i> | <i>Field Length</i>  | <i>Field Desc.</i> | <i>Field Data</i>   | <i>MSB</i> | <i>LSB</i> |
| <i>Command:<br/>IMU Stream ON</i>   | 0x75              | 0x65         | 0x0C             | 0x05                  | 0x05                 | 0x11               | Function (Apply): 0x01<br>Device (IMU): 0x01<br>Stream (ON): 0x01                   | 0x04       | 0x1A       |
| <i>Command:<br/>IMU Stream<br/>OFF</i>                                      | 0x75              | 0x65         | 0x0C             | 0x05                  | 0x05                 | 0x11               | Function (Apply): 0x01<br>Device (IMU): 0x01<br>Stream (OFF): 0x00                  | 0x03       | 0x19       |
| <i>Command:<br/>GNSS Stream<br/>ON</i>                                      | 0x75              | 0x65         | 0x0C             | 0x05                  | 0x05                 | 0x11               | Function (Apply): 0x01<br>Device (GNSS): 0x02<br>Stream (ON): 0x01                  | 0x05       | 0x1C       |
| <i>Command:<br/>GNSS Stream<br/>OFF</i>                                     | 0x75              | 0x65         | 0x0C             | 0x05                  | 0x05                 | 0x11               | Function (Apply): 0x01<br>Device (GNSS): 0x02<br>Stream (OFF): 0x00                 | 0x04       | 0x1B       |
| <i>Command:<br/>Estimation Filter<br/>Stream ON</i>                         | 0x75              | 0x65         | 0x0C             | 0x05                  | 0x05                 | 0x11               | Function (Apply): 0x01<br>Device (Estimation<br>Filter): 0x03<br>Stream (ON): 0x01  | 0x06       | 0x1E       |
| <i>Command:<br/>Estimation Filter<br/>Stream OFF</i>                        | 0x75              | 0x65         | 0x0C             | 0x05                  | 0x05                 | 0x11               | Function (Apply): 0x01<br>Device (Estimation<br>Filter): 0x03<br>Stream (OFF): 0x00 | 0x05       | 0x1D       |
| <i>Reply:<br/>ACK/NACK</i>  | 0x75              | 0x65         | 0x0C             | 0x04                  | 0x04                 | 0xF1               | Echo cmd: 0x11<br>Error code: 0x00  | 0xF0       | 0xCC       |
| <i>Copy-Paste version of the 1st command: "7565 0C05 0511 0101 0104 1A"</i> |                   |              |                  |                       |                      |                    |   |            |            |

### 4.2.11 GNSS Constellation Settings (0x0C, 0x21)

#### Description

This configures which satellite constellations and how many satellites in each constellation the receiver should track.

Function selector values:

- 0x01 - Use new settings
- 0x02 - Read back current settings.
- 0x03 - Save current settings as startup settings
- 0x04 - Load saved startup settings
- 0x05 - Reset to factory default settings

Maximum number of tracking channels to use (total for all constellations):

0 -> [Number of available channels] (from reply message)

For each constellation, you wish to configure include the following sub-fields:

Constellation ID:

- 0 - GPS (G1-G32)
- 1 - SBAS (S120-S158)
- 2 - Galileo (E1-E36)
- 3 - BeiDou (B1-B37)
- 5 - QZSS (Q1-Q5)
- 6 - GLONASS (R1-R32)

Constellation Enable:

- 0x00 - Disable
- 0x01 - Enable

Number of tracking channels (number of reserved channels for all constellations must total <= 32):





- 0 -> 32 Number of reserved channels
- 0 -> 32 Max number of channels (>= reserved channels)

Constellation Options:

- 0x0001 - L1SAIF (QZSS only)

Factory default setting is GPS and GLONASS enabled with min/max of GPS 8/16, GLONASS 8/14, SBAS 1/3, QZSS 0/3.

## 4.2.11 GNSS Constellation Settings (0x0C, 0x21)

| Field Format                           | Field Length   | Field Descriptor | Field Data   |
|--|--|------------------|--|
| <b>Notes</b>                           |  Any setting that causes the total reserved channels to exceed 32 will result in a NACK.  |                  |  |
|  |  You cannot enable GLONASS and BeiDou at the same time.   |                  |  |
|  |  Enabling SBAS and QZSS only augments GPS accuracy.   |                  |  |
|  |  It is recommended to disable GLONASS and BeiDou if a GPS-only antenna or GPS-only SAW filter is used.  |                  |  |
|  |  This u-blox SBAS implementation is, in accordance with standard RTCA/DO-229D, a class Beta-1 equipment. All timeouts etc. are chosen for the En-Route Case. Do not use this equipment under any circumstances for "safety of life" applications! |                  |  |
| <i>Command</i>                         | 6 + 6*N  | 0x21             | U8 - Function selector<br>U16 - Maximum channels to use<br>U8 - Count of constellations to configure (N)<br>N * (U8 - Constellation ID<br>U8 - Enable/Disable<br>U8 - Reserved channel count<br>U8 - Maximum channels<br>U16 - Constellation Option Flags)           |
| <i>Reply Field 1:<br/>ACK/ NACK</i>    | 0x04   | 0xF1             | U8 - echo the command descriptor<br>U8 - error code (0: ACK, non-zero: NACK)   |
| <i>Reply Field 2:<br/>Function = 2</i> | 7 + 6*N  | 0xA0             | U16 - Maximum channels available<br>U16 - Maximum channels to use<br>U8 - Count of constellations to configure (N)<br>N * (U8 - Constellation ID<br>U8 - Enable/Disable<br>U8 - Reserved channel count<br>U8 - Maximum channels<br>U16 - Constellation Option Flags) |

| Examples  | MIP Packet Header |              |                  |                       | Command/Reply Fields |                    |  | Checksum   |            |
|---|-------------------|--------------|------------------|-----------------------|----------------------|--------------------|--|------------|------------|
|   | <i>Sync1</i>      | <i>Sync2</i> | <i>Desc. Set</i> | <i>Payload Length</i> | <i>Field Length</i>  | <i>Field Desc.</i> | <i>Field Data</i>  | <i>MSB</i> | <i>LSB</i> |
| <i>Command:<br/>GNSS<br/>Constellation<br/>Settings (use<br/>new settings)</i>                          | 0x75              | 0x65         | 0x0C             | 0x12                  | 0x12                 | 0x21               | Function: 0x01<br>Max # Ch: 0x0020<br>GNSS Count: 0x02<br>1st GNSS:<br>ID (GPS): 0x00<br>Enable: 0x01<br># Resrvd Ch: 0x08<br>Max # Ch: 0x10<br>Options: 0x0000<br>2nd GNSS<br>ID (GLNS): 0x06<br>Enable: 0x01<br># Resrvd Ch: 0x08<br>Max # Ch: 0x0E<br>Options: 0x0000 | 0x84       | 0x5A       |
| <i>Reply Field:<br/>ACK/NACK</i>  | 0x75              | 0x65         | 0x0C             | 0x04                  | 0x04                 | 0xF1               | Echo cmd: 0x21<br>Error code: 0x00   | 0x00       | 0xEC       |
| <i>Copy-Paste version of the command: "7565 0C12 1221 0100 2002 0001 0810 0000 0601 080E 0000 845A"</i> |                   |              |                  |                       |                      |                    |  |            |            |

## 4.2.12 GNSS SBAS Settings (0x0C, 0x22)

|  |   |                         |  |
|--|---|-------------------------|--|
| <b>Description</b>                     | <p>This configures how SBAS satellites should be used for GNSS augmentation.</p> <p><i>Function selector values:</i></p> <ul style="list-style-type: none"> <li>0x01 - Use new settings</li> <li>0x02 - Read back current settings.</li> <li>0x03 - Save current settings as startup settings</li> <li>0x04 - Load saved startup settings</li> <li>0x05 - Reset to factory default settings</li> </ul> <p><i>SBAS Enable:</i></p> <ul style="list-style-type: none"> <li>0x00 - Disable</li> <li>0x01 - Enable (default)</li> </ul> <p><i>Options Flags:</i></p> <ul style="list-style-type: none"> <li>0x0001 - Enable ranging (default)</li> <li>0x0002 - Enable SBAS correction data (default)</li> <li>0x0004 - Apply integrity information</li> </ul> <p><i>For each satellite you wish to INCLUDE from SBAS corrections:</i></p> <p>Satellite PRN# to include</p> |                         |  |
| <b>Field Format</b>                    | <i>Field Length</i>   | <i>Field Descriptor</i> | <i>Field Data</i>  |
| <i>Command</i>                         | 7 + 2*N   | 0x21                    | U8 - Function selector<br>U8 - SBAS Enable/Disable<br>U16 - SBAS Option Flags<br>U8 - Count of Satellite PRN# to include (N)<br>N * (U16 - Satellite PRN#)   |
| <i>Reply Field 1:<br/>ACK/NACK</i>     | 0x04  | 0xF1                    | U8 - echo the command descriptor<br>U8 - error code (0: ACK, non-zero: NACK)   |
| <i>Reply Field 2:<br/>Function = 2</i> | 6 + 2*N   | 0xA1                    | U16 - Maximum channels available<br>U16 - Maximum channels to use<br>U8 - Count of constellations to configure (N)<br>N * (U8 - Constellation ID<br>U8 - Enable/Disable<br>U8 - Reserved channel count<br>U8 - Maximum channels<br>U16 - Constellation Option Flags) |

| Examples   | MIP Packet Header |              |                  |                       | Command/Reply Fields |                    |   | Checksum   |            |
|--|-------------------|--------------|------------------|-----------------------|----------------------|--------------------|---|------------|------------|
|  | <i>Sync1</i>      | <i>Sync2</i> | <i>Desc. Set</i> | <i>Payload Length</i> | <i>Field Length</i>  | <i>Field Desc.</i> | <i>Field Data</i>   | <i>MSB</i> | <i>LSB</i> |
| <i>Command</i>   | 0x75              | 0x65         | 0x0C             | 0x0B                  | 0x0B                 | 0x22               | Function: 0x01<br>SBAS En: 0x01<br>Options: 0x0003<br>PRN Cnt: 0x02<br>1st PRN Exc:<br>PRN #: 0x0078<br>2nd PRN Exc:<br>Prn #: 0x0079 | 0x16       | 0x5C       |
| <i>Reply Field :<br/>ACK/NACK</i>  | 0x75              | 0x65         | 0x0C             | 0x04                  | 0x04                 | 0xF1               | Echo cmd: 0x22<br>Error code 0x00   | 0x01       | 0xEE       |
| <i>Copy-Paste version of the command: "7565 0C0B 0B22 0101 0003 0200 7800 7916 5C"</i> |                   |              |                  |                       |                      |                    |   |            |            |

## 4.2.13 GNSS Assisted Fix Control (0x0C, 0x23)

| 4.2.13 GNSS Assisted Fix Control (0x0C, 0x23) |  |                         |  |
|---|--|-------------------------|--|
| <b>Description</b>                            | Set the options for assisted GNSS fix.   |                         |  |
| <b>Notes</b>                                  | <p>This device has a dedicated GNSS flash memory and a non-volatile FRAM. These are used to retain information about the last good GNSS fix. This greatly reduces the TTFF (Time To First Fix) depending on how old the information from the last fix is. The TTFF can be as low as under a second all the way up to an equivalent of a cold start. There is a small increase in power used when enabling assisted fix.</p> <p>Disabling assisted fix will clear all non-volatile memory of the last fix information<sup>1,2</sup>.</p> <p>The fastest fix will be obtained by supplying the 3DM with a <a href="#">GNSS Assist Time Update</a> message containing the current GPS time immediately after subsequent power up. This allows the device to determine if the last GNSS information saved is still fresh enough to improve the TTFF.</p> <p>Possible function selector values:</p> <ul style="list-style-type: none"> <li>0x01 - Use new settings</li> <li>0x02 - Read back current settings.</li> <li>0x03 - Save current settings as startup settings</li> <li>0x04 - Load saved startup settings</li> <li>0x05 - Reset to factory default settings</li> </ul> <p>Possible assisted fix options:</p> <ul style="list-style-type: none"> <li>0x00 - No assisted fix (default)</li> <li>0x01 - Enable assisted fix</li> </ul> <p>Possible assisted fix flags:</p> <ul style="list-style-type: none"> <li>Bit0 - Bit7 - No flags defined. Set to 0xFF for future compatibility (default)</li> </ul> |                         |  |
| <b>Notes</b>                                  | <ol style="list-style-type: none"> <li>1. Non-volatile GNSS memory is cleared only when going from an enabled state to a disabled state.</li> <li>2. The clearing operation results in an erase operation on the GNSS Flash. The flash has a limited durability of 100,000 write/erase cycles.</li> </ol>  |                         |  |
| <b>Field Format</b>                           | <i>Field Length</i>  | <i>Field Descriptor</i> | <i>Field Data</i>  |
| <i>Command</i>                                | 0x05   | 0x23                    | U8 - Function selector<br>U8 - Assisted fix options<br>U8 - Assisted fix flags (set to 0xFF) |
| <i>Reply:<br/>ACK/NACK</i>                    | 0x04   | 0xF1                    | U8 - echo the command descriptor<br>U8 - error code (0: ACK, non-zero: NACK)                 |

|   |                   |              |  |                       |                      |                    |  |            |            |
|---|-------------------|--------------|--|-----------------------|----------------------|--------------------|--|------------|------------|
| <i>Reply: DATA</i>  | 0x04              | 0xA2         | U8 - Current assisted fix options<br>U8 - Current assisted fix flags |                       |                      |                    |  |            |            |
| <b>Examples</b>   | MIP Packet Header |              |  |                       | Command/Reply Fields |                    |  | Checksum   |            |
|   | <i>Sync1</i>      | <i>Sync2</i> | <i>Desc. Set</i>   | <i>Payload Length</i> | <i>Field Length</i>  | <i>Field Desc.</i> | <i>Field Data</i>                              | <i>MSB</i> | <i>LSB</i> |
| <i>Command</i>  | 0x75              | 0x65         | 0x0C   | 0x05                  | 0x05                 | 0x23               | Function: 0x01<br>Options: 0x01<br>Flags: 0xFF | 0x14       | 0x60       |
| <i>Reply Field: ACK/NACK</i>  | 0x75              | 0x65         | 0x0C   | 0x04                  | 0x04                 | 0xF1               | Echo cmd: 0x23<br>Error code 0x00              | 0x02       | 0xF0       |
| <i>Copy-Paste version of the command: "7565 0C05 0523 0101 FF14 60"</i> |                   |              |  |                       |                      |                    |  |            |            |

#### 4.2.14 GNSS Assist Time Update (0x0C, 0x24)

|                        |  |                         |   |
|------------------------|--|-------------------------|---|
| <b>Description</b>     | Send GNSS Assist Time Update message.  |                         |   |
|                        | <p>This message is required immediately after power up if GNSS Assist was enabled when the device was powered off. Sending this message will reset the clock to the current time so that the GNSS receiver can get a lock on satellites based on the information it had when it was powered off. This will help reduce the time to first fix (TTFF).</p> <p>Possible function selector values:</p> <p>0x01 - Use new values<br/>0x02 - Read back current values.</p> <p>GNSS Assist Time Update Data:</p> <p>Double - Time of Week (TOW) in seconds<br/>U16 - Week Number<br/>Float - Time Accuracy in seconds</p> |                         |   |
| <b>Field Format</b>    | <i>Field Length</i>  | <i>Field Descriptor</i> | <i>Field Data</i>   |
| <i>Command</i>         | 0x11   | 0x24                    | U8 - Function selector<br>Double - Time of Week (TOW) in seconds<br>U16 - Week Number<br>Float - Time Accuracy in seconds |
| <i>Reply: ACK/NACK</i> | 0x04   | 0xF1                    | U8 - echo the command descriptor<br>U8 - error code (0: ACK, non-zero: NACK)  |
| <i>Reply: DATA</i>     | 0x10   | 0xA3                    | Double - Time of Week (TOW) in seconds  |



|                                   |                   |              |                  |                       | U16 - Week Number<br>Float - Time Accuracy in seconds |                    |  |            |            |
|-----------------------------------|-------------------|--------------|------------------|-----------------------|---|--------------------|--|------------|------------|
| Examples                          | MIP Packet Header |              |                  |                       | Command/Reply Fields                                  |                    |  | Checksum   |            |
|                                   | <i>Sync1</i>      | <i>Sync2</i> | <i>Desc. Set</i> | <i>Payload Length</i> | <i>Field Length</i>                                   | <i>Field Desc.</i> | <i>Field Data</i>  | <i>MSB</i> | <i>LSB</i> |
| <i>Command</i>                    | 0x75              | 0x65         | 0x0C             | 0x11                  | 0x11  | 0x24               | Function: 0x01<br>TOW: 47382.21<br>Week: 1921<br>Accuracy: 5.0 | -          | -          |
| <i>Reply Field :<br/>ACK/NACK</i> | 0x75              | 0x65         | 0x0C             | 0x04                  | 0x04  | 0xF1               | Echo cmd: 0x24<br>Error code 0x00                              | 0x03       | 0xF2       |

## 4.2.15 Device Startup Settings (0x0C, 0x30)

|  |  |              |                         |                       |  |                    |                                    |                 |            |
|--|--|--------------|-------------------------|-----------------------|--|--------------------|------------------------------------|-----------------|------------|
| <b>Description</b>   | <p>Read, Save, Load, or Reset to Default the values for all device settings.</p> <p>Possible function selector values:</p> <p>0x03 - Save current settings as startup settings**</p> <p>0x04 - Load saved startup settings</p> <p>0x05 - Reset to factory default settings</p> |              |                         |                       |  |                    |                                    |                 |            |
| <b>Notes</b>   | ** When a save current settings command is issued a brief data disturbance may occur as all settings are written to non-volatile memory.   |              |                         |                       |  |                    |                                    |                 |            |
| <b>Field Format</b>  | <i>Field Length</i>  |              | <i>Field Descriptor</i> |                       | <i>Field Data</i>  |                    |                                    |                 |            |
| <i>Command</i>   | 0x03   |              | 0x30                    |                       | U8 - Function selector   |                    |                                    |                 |            |
| <i>Reply:<br/>ACK/NACK</i>   | 0x04   |              | 0xF1                    |                       | U8 - echo the command byte<br>U8 - error code (0: ACK, non-zero: NACK) |                    |                                    |                 |            |
| <b>Examples</b>  | <b>MIP Packet Header</b>   |              |                         |                       | <b>Command/Reply Fields</b>  |                    |                                    | <b>Checksum</b> |            |
|  | <i>Sync1</i>   | <i>Sync2</i> | <i>Desc. Set</i>        | <i>Payload Length</i> | <i>Field Length</i>  | <i>Field Desc.</i> | <i>Field Data</i>                  | <i>MSB</i>      | <i>LSB</i> |
| <i>Command:<br/>Save All</i>                                       | 0x75   | 0x65         | 0x0C                    | 0x03                  | 0x03   | 0x30               | Fctn (Save): 0x03                  | 0x1F            | 0x45       |
| <i>Reply:<br/>ACK/NACK</i>   | 0x75   | 0x65         | 0x0C                    | 0x04                  | 0x04   | 0xF1               | Echo cmd: 0x30<br>Error code: 0x00 | 0x0F            | 0x0A       |
| <i>Copy-Paste version of the command: "7565 0C03 0330 031F 45"</i> |  |              |                         |                       |  |                    |                                    |                 |            |

## 4.2.16 Accel Bias (0x0C, 0x37)

*Advanced*

|  |   |              |                         |                       |  |                    |  |            |            |
|--|---|--------------|-------------------------|-----------------------|--|--------------------|--|------------|------------|
| <b>Description</b>   | <p>Set the value, or read the current value of the IMU7 Accelerometer Bias Vector. For all functions except 0x01 and 0x06 (apply new settings), the new vector value is ignored. The bias value is subtracted from the scaled accelerometer value prior to output.</p> <p>Possible function selector values:</p> <ul style="list-style-type: none"> <li>0x01 - Apply new settings</li> <li>0x02 - Read back current settings</li> <li>0x03 - Save current settings as startup settings</li> <li>0x04 - Load saved startup settings</li> <li>0x05 - Load factory default settings</li> <li>0x06 - Apply new settings with no ACK/NACK reply</li> </ul> |              |                         |                       |  |                    |  |            |            |
| <b>Field Format</b>  | <i>Field Length</i>   |              | <i>Field Descriptor</i> |                       | <i>Field Data</i>  |                    |  |            |            |
| <i>Command</i>   | 0x0F  |              | 0x37                    |                       | U8 - Function selector<br>float - X Accel Bias Value<br>float - Y Accel Bias Value<br>float - Z Accel Bias Value |                    |  |            |            |
| <i>Reply Field 1:<br/>ACK/NACK</i>   | 0x04  |              | 0xF1                    |                       | U8 - echo the command byte<br>U8 - error code (0: ACK, non-zero: NACK)   |                    |  |            |            |
| <i>Reply Field 2:<br/>Function = 2</i>   | 0x0E  |              | 0x9A                    |                       | float - Current X Accel Bias Value<br>float - Current Y Accel Bias Value<br>float - Current Z Accel Bias Value   |                    |  |            |            |
| <b>Examples</b>  | MIP Packet Header   |              |                         |                       | Command/Reply Fields   |                    |  | Checksum   |            |
|  | <i>Sync1</i>  | <i>Sync2</i> | <i>Desc. Set</i>        | <i>Payload Length</i> | <i>Field Length</i>  | <i>Field Desc.</i> | <i>Field Data</i>  | <i>MSB</i> | <i>LSB</i> |
| <i>Command:<br/>Accel Bias</i>   | 0x75  | 0x65         | 0x0C                    | 0x0F                  | 0x0F   | 0x37               | Fctn (Apply): 0x01<br>Field (Bias): 0x00000000<br>0x00000000<br>0x00000000 | 0x3C       | 0x75       |
| <i>Reply Field:<br/>ACK/NACK</i>   | 0x75  | 0x65         | 0x0C                    | 0x04                  | 0x04   | 0xF1               | Echo cmd: 0x37<br>Error code: 0x00   | 0x16       | 0x18       |
| <i>Copy-Paste version of the command: "7565 0C0F 0F37 0100 0000 0000 0000 0000 0000 003C 75"</i> |   |              |                         |                       |  |                    |  |            |            |

## 4.2.17 Gyro Bias (0x0C, 0x38)

*Advanced*

|  |   |              |                         |                       |   |                    |  |            |            |
|--|---|--------------|-------------------------|-----------------------|---|--------------------|--|------------|------------|
| <b>Description</b>   | <p>Set the value, or read the current value of the IMU7 Gyro Bias Vector. For all functions except 0x01 and 0x06 (apply new settings), the new vector value is ignored. The bias value is subtracted from the scaled Gyro value prior to output.</p> <p>Possible function selector values:</p> <ul style="list-style-type: none"> <li>0x01 - Apply new settings</li> <li>0x02 - Read back current settings</li> <li>0x03 - Save current settings as startup settings</li> <li>0x04 - Load saved startup settings</li> <li>0x05 - Load factory default settings</li> <li>0x06 - Apply new settings with no ACK/NACK reply</li> </ul> |              |                         |                       |   |                    |  |            |            |
| <b>Field Format</b>  | <i>Field Length</i>   |              | <i>Field Descriptor</i> |                       | <i>Field Data</i>   |                    |  |            |            |
| <i>Command</i>   | 0x0F  |              | 0x38                    |                       | U8 - Function selector<br>float - X Gyro Bias Value<br>float - Y Gyro Bias Value<br>float - Z Gyro Bias Value |                    |  |            |            |
| <i>Reply Field 1:<br/>ACK/NACK</i>   | 0x04  |              | 0xF1                    |                       | U8 - echo the command byte<br>U8 - error code (0: ACK, non-zero: NACK)  |                    |  |            |            |
| <i>Reply Field 2:<br/>Function = 2</i>   | 0x0E  |              | 0x9B                    |                       | float - Current X Gyro Bias Value<br>float - Current Y Gyro Bias Value<br>float - Current Z Gyro Bias Value   |                    |  |            |            |
| <b>Examples</b>  | MIP Packet Header   |              |                         |                       | Command/Reply Fields  |                    |  | Checksum   |            |
|  | <i>Sync1</i>  | <i>Sync2</i> | <i>Desc. Set</i>        | <i>Payload Length</i> | <i>Field Length</i>   | <i>Field Desc.</i> | <i>Field Data</i>  | <i>MSB</i> | <i>LSB</i> |
| <i>Command:<br/>Gyro Bias</i>  | 0x75  | 0x65         | 0x0C                    | 0x0F                  | 0x0F  | 0x38               | Fctn (Apply): 0x01<br>Field (Bias): 0x00000000<br>0x00000000<br>0x00000000 | 0x3D       | 0x83       |
| <i>Reply Field:<br/>ACK/NACK</i>   | 0x75  | 0x65         | 0x0C                    | 0x04                  | 0x04  | 0xF1               | Echo cmd: 0x38<br>Error code: 0x00   | 0x17       | 0x1A       |
| <i>Copy-Paste version of the command: "7565 0C0F 0F38 0100 0000 0000 0000 0000 0000 003D 83"</i> |   |              |                         |                       |   |                    |  |            |            |

## 4.2.18 Capture Gyro Bias (0x0C, 0x39)

|  |  |                         |                  |                       |   |                    |  |                 |            |
|--|--|-------------------------|------------------|-----------------------|---|--------------------|--|-----------------|------------|
| <b>Description</b>   | <p>This command will cause the 3DM-GX5-45 to sample its sensors for the specified number of milliseconds. The resulting data will be used to initialize its orientation, and to estimate its gyro bias error. The estimated gyro bias error will be automatically written to the Gyro Bias vector. The bias vector is not saved as a startup value. If you wish to save this vector, use the <a href="#">Gyro Bias</a> command.</p> <p>Possible sampling time values:<br/> Total sampling time in units of milliseconds.<br/> Range of values: 1000 to 30,000.</p> |                         |                  |                       |   |                    |  |                 |            |
| <b>Notes</b>   | Note: The 3DM-GX5-45 must be stationary during the execution of the Capture Gyro Bias operation.   |                         |                  |                       |   |                    |  |                 |            |
| <b>Field Format</b>  | <i>Field Length</i>  | <i>Field Descriptor</i> |                  |                       | <i>Field Data</i>   |                    |  |                 |            |
| <i>Command</i>   | 0x04   | 0x39                    |                  |                       | U16 - Sampling Time (milliseconds)  |                    |  |                 |            |
| <i>Reply Field 1: ACK/NACK</i>                                       | 0x04   | 0xF1                    |                  |                       | U8 - echo the command byte<br>U8 - error code (0: ACK, non-zero: NACK)                                      |                    |  |                 |            |
| <i>Reply Field 2: Function = 2</i>                                   | 0x0E   | 0x9B                    |                  |                       | float - Current X Gyro Bias Value<br>float - Current Y Gyro Bias Value<br>float - Current Z Gyro Bias Value |                    |  |                 |            |
| <b>Examples</b>  | <b>MIP Packet Header</b>   |                         |                  |                       | <b>Command/Reply Fields</b>   |                    |  | <b>Checksum</b> |            |
|  | <i>Sync1</i>   | <i>Sync2</i>            | <i>Desc. Set</i> | <i>Payload Length</i> | <i>Field Length</i>   | <i>Field Desc.</i> | <i>Field Data</i>                                    | <i>MSB</i>      | <i>LSB</i> |
| <i>Command: Capture Gyro Bias</i>                                    | 0x75   | 0x65                    | 0x0C             | 0x04                  | 0x04  | 0x39               | Sampling Time: 0x2710                                | 0x5E            | 0xE0       |
| <i>Reply Field 1: ACK/NACK</i>                                       | 0x75   | 0x65                    | 0x0C             | 0x04                  | 0x04  | 0xF1               | Echo cmd: 0x39<br>Error code: 0x00                   |                 |            |
| <i>Reply Field 2: Bias Vector</i>                                    |  |                         |                  |                       | 0x0E  | 0x9B               | Field (Bias): 0x00000000<br>0x00000000<br>0x00000000 | 0xCF            | 0x19       |
| <i>Copy-Paste version of the command: "7565 0C04 0439 2710 5EE0"</i> |  |                         |                  |                       |   |                    |  |                 |            |

## 4.2.19 Magnetometer Hard Iron Offset (0x0C, 0x3A)

|  |   |                     |  |                       |                             |                    |   |                 |            |
|--|---|---------------------|--|-----------------------|-----------------------------|--------------------|---|-----------------|------------|
| <b>Description</b>                     | <p>This command will read or write values to the magnetometer Hard Iron Offset Vector.</p> <p>For all functions except 0x01 and 0x06 (apply new settings), the new vector value is ignored. The offset value is subtracted from the scaled Mag value prior to output.</p> <p>The values for this offset are determined empirically by external software algorithms based on calibration data taken after the device is installed in its application. These values can be obtained and set by using the LORD “MIP Iron Calibration” application. Alternatively, the <a href="#">auto-mag calibration</a> feature may be used to capture these values in-run. The offset is applied to the scaled magnetometer vector prior to output.</p> <p>Possible function selector values:</p> <ul style="list-style-type: none"> <li>0x01 - Apply new settings</li> <li>0x02 - Read back current settings</li> <li>0x03 - Save current settings as startup settings</li> <li>0x04 - Load saved startup settings</li> <li>0x05 - Load factory default settings</li> <li>0x06 - Apply new settings with no ACK/NACK reply</li> </ul> <p>Default values:</p> <p style="text-align: center;">Hard Iron Offset: [0,0,0]</p> |                     |  |                       |                             |                    |   |                 |            |
|  | <b>Field Format</b>   | <i>Field Length</i> | <i>Field Descriptor</i>  | <i>Field Data</i>     |                             |                    |   |                 |            |
| <i>Command</i>                         | 0x0F  | 0x3A                | U8 - Function selector<br>float - X Hard Iron Offset<br>float - Y Hard Iron Offset<br>float - Z Hard Iron Offset |                       |                             |                    |   |                 |            |
| <i>Reply Field 1:<br/>ACK/ NACK</i>    | 0x04  | 0xF1                | U8 - echo the command byte<br>U8 - error code (0: ACK, non-zero: NACK)   |                       |                             |                    |   |                 |            |
| <i>Reply Field 2:<br/>Function = 2</i> | 0x0E  | 0x9C                | float - Current X Hard Iron Offset<br>float - Current Y Hard Iron Offset<br>float - Current Z Hard Iron Offset   |                       |                             |                    |   |                 |            |
| <b>Examples</b>                        | <b>MIP Packet Header</b>  |                     |  |                       | <b>Command/Reply Fields</b> |                    |   | <b>Checksum</b> |            |
|  | <i>Sync1</i>  | <i>Sync2</i>        | <i>Desc. Set</i>   | <i>Payload Length</i> | <i>Field Length</i>         | <i>Field Desc.</i> | <i>Field Data</i>   | <i>MSB</i>      | <i>LSB</i> |
| <i>Command:<br/>Hard Iron Offset</i>   | 0x75  | 0x65                | 0x0C   | 0x0F                  | 0x0F                        | 0x3A               | Fctn (Apply): 0x01<br>Offset Vector: 0x00000000<br>0x00000000<br>0x00000000 | 0x3F            | 0x9F       |

|   |      |      |      |      |      |      |                                    |      |      |
|---|------|------|------|------|------|------|------------------------------------|------|------|
| <i>Reply Field:<br/>ACK/NACK</i>  | 0x75 | 0x65 | 0x0C | 0x04 | 0x04 | 0xF1 | Echo cmd: 0x3A<br>Error code: 0x00 | 0x19 | 0x1E |
| <i>Copy-Paste version of the command: "7565 0C0F 0F3A 0100 0000 0000 0000 0000 003F 9F"</i> |      |      |      |      |      |      |                                    |      |      |

#### 4.2.20 Magnetometer Soft Iron Matrix (0x0C, 0x3B)

|  |  |                     |   |
|--|--|---------------------|---|
| <b>Description</b>                     | <p>This command will read or write values to the magnetometer Soft Iron Compensation Matrix.</p> <p>The values for this matrix are determined empirically by external software algorithms based on calibration data taken after the device is installed in its application. These values can be obtained and set by using the LORD "MIP Iron Calibration" application. Alternatively, the <a href="#">auto-mag calibration</a> feature may be used to capture these values in-run. The matrix is applied to the scaled magnetometer vector prior to output</p> <p>Possible function selector values:</p> <ul style="list-style-type: none"> <li>0x01 - Apply new settings</li> <li>0x02 - Read back current settings</li> <li>0x03 - Save current settings as startup settings</li> <li>0x04 - Load saved startup settings</li> <li>0x05 - Load factory default settings</li> <li>0x06 - Apply new settings with no ACK/NACK reply</li> </ul> <p>Default values:</p> <p>Soft Iron Compensation Matrix: (identity matrix; row order):<br/>[1,0,0][0,1,0][0,0,1]</p> |                     |   |
|  | <b>Field Format</b>  | <i>Field Length</i> | <i>Field Descriptor</i>   |
| <i>Command</i>                         | 0x27   | 0x3B                | U8 - Function selector<br>float - $m_{1,1}$ float - $m_{1,2}$ float - $m_{1,3}$<br>float - $m_{2,1}$ float - $m_{2,2}$ float - $m_{2,3}$<br>float - $m_{3,1}$ float - $m_{3,2}$ float - $m_{3,3}$ |
| <i>Reply Field 1:<br/>ACK/ NACK</i>    | 0x04   | 0xF1                | U8 - echo the command descriptor<br>U8 - error code (0: ACK, non-zero: NACK)  |
| <i>Reply Field 2:<br/>Function = 2</i> | 0x26   | 0x9D                | float - $m_{1,1}$ float - $m_{1,2}$ float - $m_{1,3}$<br>float - $m_{2,1}$ float - $m_{2,2}$ float - $m_{2,3}$<br>float - $m_{3,1}$ float - $m_{3,2}$ float - $m_{3,3}$                           |

| Examples  | MIP Packet Header |              |                  |                       | Command/Reply Fields |                    |   | Checksum   |            |
|---|-------------------|--------------|------------------|-----------------------|----------------------|--------------------|---|------------|------------|
|   | <i>Sync1</i>      | <i>Sync2</i> | <i>Desc. Set</i> | <i>Payload Length</i> | <i>Field Length</i>  | <i>Field Desc.</i> | <i>Field Data</i>   | <i>MSB</i> | <i>LSB</i> |
| <i>Command:<br/>Soft Iron Matrix</i>  | 0x75              | 0x65         | 0x0C             | 0x27                  | 0x27                 | 0x3B               | Fctn (Apply): 0x01<br>Comp Matrix: 0x3F800000<br>0x00000000<br>0x00000000<br>0x00000000<br>0x3F800000<br>0x00000000<br>0x00000000<br>0x00000000<br>0x3F800000 | 0xAD       | 0x59       |
| <i>Reply Field:<br/>ACK/NACK</i>  | 0x75              | 0x65         | 0x0C             | 0x12                  | 0x04                 | 0xF1               | Echo cmd: 0x3B<br>Error code: 0x00  | 0x1A       | 0x20       |
| <i>Copy-Paste version of the command: "7565 0C27 273B 013F 8000 0000 0000 0000 0000 0000 0000 003F 8000 0000 0000 0000 0000 0000 003F 8000 00AD 59"</i> |                   |              |                  |                       |                      |                    |   |            |            |



## 4.2.21 Coning and Sculling Enable (0x0C, 0x3E)

|  |   |                         |                  |                       |  |                    |                                    |            |            |
|--|---|-------------------------|------------------|-----------------------|--|--------------------|------------------------------------|------------|------------|
| <b>Description</b>   | Set, read, or save the Coning and Sculling Compensation Enable. This function sets the Coning and Sculling Compensation Enable. For all functions except 0x01 (use new setting), the new parameter values are ignored.  |                         |                  |                       |  |                    |                                    |            |            |
|  | Possible function selector values:<br>0x01 - Apply new settings<br>0x02 - Read back current settings<br>0x03 - Save current settings as startup settings<br>0x04 - Load saved startup settings<br>0x05 - Load factory default settings<br><br>The enable flag can be either:<br><br>0x00 - Disable the Coning and Sculling compensation<br>0x01 - Enable the Coning and Sculling compensation (default) |                         |                  |                       |  |                    |                                    |            |            |
| <b>Field Format</b>  | <i>Field Length</i>   | <i>Field Descriptor</i> |                  |                       | <i>Field Data</i>  |                    |                                    |            |            |
| <i>Command</i>   | 0x10  | 0x3E                    |                  |                       | U8 - Function selector<br>U8 - New Coning and Sculling enable setting        |                    |                                    |            |            |
| <i>Reply Field 1:<br/>ACK/NACK</i>                                   | 0x04  | 0xF1                    |                  |                       | U8 - echo the command descriptor<br>U8 - error code (0: ACK, non-zero: NACK) |                    |                                    |            |            |
| <i>Reply Field 2:<br/>Function = 2</i>                               | 0x03  | 0x9E                    |                  |                       | U8 - Current Coning and Sculling enable setting                              |                    |                                    |            |            |
| <b>Examples</b>  | MIP Packet Header   |                         |                  |                       | Command/Reply Fields   |                    |                                    | Checksum   |            |
|  | <i>Sync1</i>  | <i>Sync2</i>            | <i>Desc. Set</i> | <i>Payload Length</i> | <i>Field Length</i>  | <i>Field Desc.</i> | <i>Field Data</i>                  | <i>MSB</i> | <i>LSB</i> |
| <i>Command:<br/>Enable Settings</i>                                  | 0x75  | 0x65                    | 0x0C             | 0x04                  | 0x04   | 0x3E               | Fctn (Apply): 0x01<br>Enable: 0x01 | 0x2E       | 0x94       |
| <i>Reply Field:<br/>ACK/NACK</i>                                     | 0x75  | 0x65                    | 0x0C             | 0x04                  | 0x04   | 0xF1               | Echo cmd: 0x38<br>Error code: 0x00 | 0x1D       | 0x26       |
| <i>Copy-Paste version of the command: "7565 0C04 043E 0101 2E94"</i> |   |                         |                  |                       |  |                    |                                    |            |            |

## 4.2.22 UART Baud Rate (0x0C, 0x40)

|  |   |              |                         |                       |  |                    |   |            |            |
|--|---|--------------|-------------------------|-----------------------|--|--------------------|---|------------|------------|
| <b>Description</b>   | <p>Change, read, or save the baud rate of the main communication channel (UART1). For all functions except 0x01 (use new settings), the new baud rate value is ignored.</p> <p>Possible function selector values:</p> <ul style="list-style-type: none"> <li>0x01 - Apply new settings</li> <li>0x02 - Read back current settings</li> <li>0x03 - Save current settings as startup settings</li> <li>0x04 - Load saved startup settings</li> <li>0x05 - Reset to factory default settings</li> </ul> <p>Supported baud rates are:</p> <p>9600, 19200, 115200 (<i>default</i>), 230400, 460800, 921600</p> |              |                         |                       |  |                    |   |            |            |
| <b>Notes</b>   |  <i>The ACK/NACK packet is sent at the current baud rate and then there is a 0.25 second delay before the device will respond to commands at the new BAUD rate.</i>  |              |                         |                       |  |                    |   |            |            |
| <b>Field Format</b>  | <i>Field Length</i>   |              | <i>Field Descriptor</i> |                       | <i>Field Data</i>  |                    |   |            |            |
| <i>Command</i>   | 0x07  |              | 0x40                    |                       | U8 - Function selector<br>U32 - New baud rate                                |                    |   |            |            |
| <i>Reply Field 1:<br/>ACK/ NACK</i>  | 0x04  |              | 0xF1                    |                       | U8 - Echo the command descriptor<br>U8 - Error code (0: ACK, non-zero: NACK) |                    |   |            |            |
| <i>Reply Field 2:<br/>Function = 2</i>                                       | 0x06  |              | 0x87                    |                       | U32 - Current baud rate  |                    |   |            |            |
| <b>Examples</b>  | MIP Packet Header   |              |                         |                       | Command/Reply Fields   |                    |   | Checksum   |            |
|  | <i>Sync1</i>  | <i>Sync2</i> | <i>Desc. Set</i>        | <i>Payload Length</i> | <i>Field Length</i>  | <i>Field Desc.</i> | <i>Field Data</i>                             | <i>MSB</i> | <i>LSB</i> |
| <i>Command:<br/>Set Baud Rate</i>  | 0x75  | 0x65         | 0x0C                    | 0x07                  | 0x07   | 0x40               | Fctn (USE): 0x01<br>Baud (115200): 0x0001C200 | 0xF8       | 0xDA       |
| <i>Reply Field:<br/>ACK/NACK</i>   | 0x75  | 0x65         | 0x0C                    | 0x04                  | 0x04   | 0xF1               | Echo cmd: 0x40<br>Error code: 0x00            | 0x1F       | 0x2A       |
| <i>Copy-Paste version of the command: "7565 0C07 0740 0100 01C2 00F8 DA"</i> |   |              |                         |                       |  |                    |   |            |            |

## 4.2.23 Advanced Low-Pass Filter Settings (0x0C, 0x50)

|                    |   |                     |                         |
|--------------------|---|---------------------|-------------------------|
| <b>Description</b> | <p>Advanced configuration for low-pass filter settings.</p> <p>The scaled data quantities are <b>by default</b> filtered through a single-pole IIR low-pass filter which is configured with a -3dB cutoff frequency of half the reporting frequency (set by decimation factor in the <a href="#">IMU Message Format</a> command) to prevent aliasing on a per data quantity basis. This advanced configuration command allows for the cutoff frequency to be configured independently of the data reporting frequency as well as allowing for a complete bypass of the digital low-pass filter.</p> <p>Possible function selector values:</p> <ul style="list-style-type: none"> <li>0x01 - Apply new settings</li> <li>0x02 - Read back current settings</li> <li>0x03 - Save current settings as startup settings</li> <li>0x04 - Load saved startup settings</li> <li>0x05 - Reset to factory default settings</li> </ul> <p>Possible data descriptors:</p> <ul style="list-style-type: none"> <li>0x04 - Scaled accel data</li> <li>0x05 - Scaled gyro data</li> <li>0x06 - Scaled mag data (if applicable)</li> <li>0x17 - Scaled pressure data</li> </ul> <p>Possible filter enable values:</p> <ul style="list-style-type: none"> <li>0x01 - Apply low-pass filter</li> <li>0x00 - Do not apply low-pass filter</li> </ul> <p>Manual filter bandwidth configuration:</p> <ul style="list-style-type: none"> <li>0x01 - Use user specified -3 dB cutoff frequency</li> <li>0x00 - Automatically configure -3 dB cutoff frequency to half reporting rate</li> </ul> <p>-3 dB Cutoff Frequency:</p> <p>Cutoff Frequency value specified must be no greater than 250 Hz.<br/> <i>**This value in a write command is ignored if Automatic Bandwidth is selected.</i></p> <p>Reserved Byte:</p> <p>This byte is reserved for internal use and should be left in the 0x00 state</p> |                     |                         |
|                    | <b>Field Format</b>   | <i>Field Length</i> | <i>Field Descriptor</i> |

| <i>Command</i>  | 0x09              | 0x50         | U8 - Function selector<br>U8 - Data Descriptor<br>U8 - Low-Pass Filter Enable/Disable<br>U8 - Manual/Auto -3 dB Cutoff Frequency Configuration<br>U16 - -3 dB Cutoff Frequency<br>U8 - Reserved Byte |                       |                      |                    |  |            |            |
|---|-------------------|--------------|--|-----------------------|----------------------|--------------------|--|------------|------------|
| <i>Reply Field 1:<br/>ACK/NACK</i>  | 0x04              | 0xF1         | U8 - echo the command descriptor<br>U8 - error code (0: ACK, non-zero: NACK)   |                       |                      |                    |  |            |            |
| <i>Reply Field 2:<br/>Function = 2</i>  | 0x08              | 0x8B         | U8 - Data Descriptor<br>U8 - Filter (0x01: Enabled, 0x00: Disabled)<br>U8 - Cutoff Frequency (0x00: Auto, 0x01: Manual)<br>U16 - -3 dB Cutoff Frequency Hz<br>U8 - Reserved                          |                       |                      |                    |  |            |            |
| Examples  | MIP Packet Header |              |  |                       | Command/Reply Fields |                    |  | Checksum   |            |
|   | <i>Sync1</i>      | <i>Sync2</i> | <i>Desc. Set</i>   | <i>Payload Length</i> | <i>Field Length</i>  | <i>Field Desc.</i> | <i>Field Data</i>  | <i>MSB</i> | <i>LSB</i> |
| <i>Command</i>  | 0x75              | 0x65         | 0x0C   | 0x09                  | 0x09                 | 0x50               | Fctn (Apply): 0x01<br>Scaled Accel: 0x04<br>Enable Filter: 0x01<br>Automatic Cutoff Configuration: 0x00<br>-3dB Cutoff Frequency (ignored for 0x0000 automatic cutoff configuration)<br>Reserved: 0x00 | 0x4C       | 0x6D       |
| <i>Reply Field :<br/>ACK/NACK</i>   | 0x75              | 0x65         | 0x0C   | 0x04                  | 0x04                 | 0xF1               | Echo cmd: 0x50<br>Error code: 0x00   | 0x2F       | 0x4A       |
| <i>Copy-Paste version of the command: "7565 0C09 0950 0104 0100 0000 004E 80"</i> |                   |              |  |                       |                      |                    |  |            |            |

## 4.2.24 Complementary Filter Settings (0x0C, 0x51)

|  |   |                         |   |
|--|---|-------------------------|---|
| <b>Description</b>                     | <p>Configuration for the AHRS complementary filter. The Complementary Filter data outputs are supported in the IMU/AHRS Data set (0x80) to provide compatibility with the 3DM-GX3.</p> <p>Possible function selector values:</p> <ul style="list-style-type: none"> <li>0x01 - Use new settings</li> <li>0x02 - Read back current settings</li> <li>0x03 - Save current settings as startup settings</li> <li>0x04 - Load saved startup settings</li> <li>0x05 - Reset to factory default settings</li> </ul> <p>Possible up/north compensation enable values:</p> <ul style="list-style-type: none"> <li>0x00 - Disable</li> <li>0x01 - Enable (default)</li> </ul> <p>Range of up/north compensation time constants:</p> <p>1-1000 seconds, default = 10 seconds</p> <p>Values outside of the specified range for up/north compensation will be NACK'd.</p> |                         |   |
| <b>Notes</b>                           |  <p><i>The Complementary Filter provides attitude outputs (Matrix, Euler, Quaternion, Up, and North) that are independent of the Estimation Filter outputs. The CF outputs are calculated using the same algorithm as the 3DM-GX5 series of Inertial Devices. This provides drop-in compatibility that duplicates the performance of the 3DM-GX5. It is highly recommended that you transition to the EF outputs as they will provide better performance as well as compatibility with higher grade devices such as the 3DM-RQ1.</i></p>   |                         |   |
| <b>Field Format</b>                    | <i>Field Length</i>   | <i>Field Descriptor</i> | <i>Field Data</i>   |
| <i>Command</i>                         | 0x0D  | 0x51                    | U8 - Function selector<br>U8 - Up compensation enable<br>U8 - North compensation enable<br>float - Up compensation time constant (sec)<br>float - North compensation time constant (sec)<br>U8 - echo the command descriptor<br>U8 - error code (0:ACK, not 0:NACK) |
| <i>Reply Field 1:<br/>ACK/ NACK</i>    | 0x04  | 0xF1                    | U8 - echo the command descriptor<br>U8 - error code (0: ACK, non-zero: NACK)  |
| <i>Reply Field 2:<br/>Function = 2</i> | 0x0C  | 0x97                    | U8 - Up compensation enable<br>U8 - North compensation enable   |

| Examples   | MIP Packet Header |              |                  |                       | Command/Reply Fields |                    |   | Checksum   |            |
|--|-------------------|--------------|------------------|-----------------------|----------------------|--------------------|---|------------|------------|
|  | <i>Sync1</i>      | <i>Sync2</i> | <i>Desc. Set</i> | <i>Payload Length</i> | <i>Field Length</i>  | <i>Field Desc.</i> | <i>Field Data</i>   | <i>MSB</i> | <i>LSB</i> |
| <i>Command</i>   | 0x75              | 0x65         | 0x0C             | 0x0D                  | 0x0D                 | 0x51               | Fctn Selector (Write): 0x01<br>Up Compensation Enable: 0x01<br>North Compensation Enable: 0x01<br>Up Compensation Time Constant: 5.0 (sec)<br>North Compensation Time Constant: 5.0 (sec) | 0xXX       | 0xXX       |
| <i>Reply Field: ACK/NACK</i>   | 0x75              | 0x65         | 0x0C             | 0x04                  | 0x04                 | 0xF1               | Echo cmd: 0x51<br>Error code: 0x00  | 0x         | 0x         |
| <i>Copy-Paste version of the command: "7565 0C09 0951 0104 0100 0000 00"</i> |                   |              |                  |                       |                      |                    |   |            |            |

#### 4.2.25 Device Status (0x0C, 0x64)

|                    |   |
|--------------------|---|
| <b>Description</b> | <p>Get the device-specific status for the 3DM-GX5-45.</p> <p>Reply has two fields: "ACK/NACK" and "Device Status Field". The device status field may be one of two selectable formats - basic and diagnostic.</p> <p>The reply data for this command is device specific. The reply is specified by two parameters in the command. The first parameter is the model number (which for the 3DM-GX5-45 is always = 6251 (0x186B)). That is followed by a status selector byte which determines the type of data structure returned. In the case of the 3DM-GX5-45, there are two selector values - one to return a basic status structure and a second to return an extensive diagnostics status structure. A list of available values for the selector values and specific fields in the data structure are as follows:</p> <p>Possible Status Selector Values:</p> <ul style="list-style-type: none"> <li>0x01 - Basic Status Structure</li> <li>0x02 - Diagnostic Status Structure</li> </ul> |
| <b>Notes</b>       | <p> <i>The reply field for this command is tightly tied to the model number. Make sure you check the model number in the reply and match it to the correct structure for the data field for the specific device model number. This reply data descriptor 0x0C, 0x90 is an</i></p>  |

## 4.2.25 Device Status (0x0C, 0x64)

*exception to the rule for MIP descriptors that the structure of descriptor data is the same for all devices. In this case, it is the same for all devices with the same model number but not necessarily the same for devices with different model numbers.*

| Field Format   | Field Length | Field Descriptor | Field Data   |                                 |                  |                   |
|--|--------------|------------------|--|---------------------------------|------------------|-------------------|
| <i>Command</i>   | 0x02         | 0x64             | U16-Device Model Number: set = 6251 (0x186B)<br>U8-Status Selector     |                                 |                  |                   |
| <i>Reply Field 1:<br/>ACK/NACK</i>                               | 0x04         | 0xF1             | U8 - echo the command byte<br>U8 - error code (0: ACK, non-zero: NACK) |                                 |                  |                   |
| <i>Reply Field 2:<br/>Basic Device<br/>Status Field</i>          | 0x0F         | 0x90             | <i>Binary Offset</i>   | <i>Description</i>              | <i>Data Type</i> | <i>Units</i>      |
|  |              |                  | 0  | Echo of the Device Model Number | U16              | N/A               |
|  |              |                  | 2  | Echo of the selector byte       | U8               | N/A               |
|  |              |                  | 3  | Status Flags (Reserved)         | U32              | N/A               |
|  |              |                  | 7  | System State                    | U16              | N/A               |
|  |              |                  | 9  | System Timer (since start-up)   | U32              | millisecond       |
| <i>Reply Field 2:<br/>Diagnostic<br/>Device Status<br/>Field</i> | 0x4F         | 0x90             | <i>Binary Offset</i>   | <i>Description</i>              | <i>Data Type</i> | <i>Units</i>      |
|  |              |                  | 0  | Echo of the Device Model Number | U16              | N/A               |
|  |              |                  | 2  | Echo of the selector byte       | U8               | N/A               |
|  |              |                  | 3  | Status Flags (Reserved)         | U32              | N/A               |
|  |              |                  | 7  | System State                    | U16              | N/A               |
|  |              |                  | 9  | System Timer (since start-up)   | U32              | millisecond       |
|  |              |                  | 13   | GNSS Power State                | U8               | 1 - on<br>0 - off |
|  |              |                  | 14   | Number of 1PPS Pulses           | U32              | Count             |
|  |              |                  | 18   | Last 1PPS (System Timer)        | U32              | milliseconds      |
|  |              |                  | 22   | IMU Stream Enabled              | U8               | 1 - on<br>0 - off |

|   |                                       |              |                  |  |                             |                    |  |                 |             |
|---|---------------------------------------|--------------|------------------|--|-----------------------------|--------------------|--|-----------------|-------------|
|   |                                       |              | 23               | GNSS Stream Enabled                                    | U8                          | 1 - on<br>0 - off  |  |                 |             |
|   |                                       |              | 24               | Estimation Filter Stream Enabled                       | U8                          | 1 - on<br>0 - off  |  |                 |             |
|   |                                       |              | 25               | Outgoing IMU Stream Dropped Packet Count               | U32                         | count              |  |                 |             |
|   |                                       |              | 29               | Outgoing GNSS Stream Dropped Packet Count              | U32                         | count              |  |                 |             |
|   |                                       |              | 33               | Outgoing Estimation Filter Stream Dropped Packet Count | U32                         | count              |  |                 |             |
|   |                                       |              | 37               | Number of bytes written to com port                    | U32                         | count              |  |                 |             |
|   |                                       |              | 41               | Number of bytes read from com port                     | U32                         | count              |  |                 |             |
|   |                                       |              | 45               | Number of overruns when writing to com port            | U32                         | count              |  |                 |             |
|   |                                       |              | 49               | Number of overruns when reading from com port          | U32                         | count              |  |                 |             |
|   |                                       |              | 53               | Number of IMU message parsing errors                   | U32                         | count              |  |                 |             |
|   |                                       |              | 57               | Total IMU messages read                                | U32                         | count              |  |                 |             |
|   |                                       |              | 61               | Last IMU message read (System Timer)                   | U32                         | millisecond        |  |                 |             |
|   |                                       |              | 65               | Number of GNSS message parsing errors                  | U32                         | count              |  |                 |             |
|   |                                       |              | 69               | Total GNSS messages read                               | U32                         | count              |  |                 |             |
| 73  | Last GNSS message read (System Timer) | U32          | millisecond      |  |                             |                    |  |                 |             |
| <b>Examples</b>   | <b>MIP Packet Header</b>              |              |                  |  | <b>Command/Reply Fields</b> |                    |  | <b>Checksum</b> |             |
|   | <i>Sync1</i>                          | <i>Sync2</i> | <i>Desc. Set</i> | <i>Payload Length</i>                                  | <i>Field Length</i>         | <i>Field Desc.</i> | <i>Field Data</i>  | <i>MSB</i>      | <i>LSB</i>  |
| <i>Command: Get Device Status (return Basic Status structure: selector = 1)</i> | <b>0x75</b>                           | <b>0x65</b>  | <b>0x0C</b>      | <b>0x05</b>  | <b>0x05</b>                 | <b>0x64</b>        | Model # (6251): <b>0x186B</b><br>Status selector (basic status): <b>0x01</b> | <b>0xD8</b>     | <b>0x7F</b> |



|  |      |      |      |      |      |      |  |      |      |
|--|------|------|------|------|------|------|--|------|------|
| <i>Reply Field 1:<br/>ACK/NACK</i>                                       | 0x75 | 0x65 | 0x0C | 0x15 | 0x04 | 0xF1 | Echo cmd: 0x64<br>Error code: 0x00   |      |      |
| <i>Reply Field 2:<br/>Device Status<br/>(Basic Status<br/>structure)</i> |      |      |      |      | 0x0D | 0x90 | Echo Model # (6251): 0x186B<br>Echo selector: 0x01<br>Additional data: ... | 0x## | 0x## |
| <i>Copy-Paste version of the command: "7565 0C05 0564 186B 01D8 7F"</i>  |      |      |      |      |      |      |  |      |      |

#### 4.2.26 Raw RTCM 2.3 Message (0x0C, 0x20)

|   |   |              |                  |                         |                      |  |                                    |            |            |
|---|---|--------------|------------------|-------------------------|----------------------|--|------------------------------------|------------|------------|
| <b>Description</b>                            | Send Raw RTCM 2.3 differential corrections to the device.   |              |                  |                         |                      |  |                                    |            |            |
| <b>Notes</b>                                  | <p>The device currently only accepts message types 1, 2, 3, and 9. RTK corrections are not supported.</p> <p>The RTCM data can be limited to 1 message per command or streamed into the device by dividing the stream into reasonably-sized chunks (no greater than 253 bytes.)</p> |              |                  |                         |                      |  |                                    |            |            |
| <b>Field Format</b>                           | <i>Field Length</i>   |              |                  | <i>Field Descriptor</i> |                      | <i>Field Data</i>  |                                    |            |            |
| <i>Command</i>                                | 0x2 + Num_bytes   |              |                  | 0x20                    |                      | Num_bytes of the raw RTCM2.3 stream  |                                    |            |            |
| <i>Reply Field:<br/>ACK/NACK</i>              | 0x04  |              |                  | 0xF1                    |                      | U8 - echo the command descriptor<br>U8 - error code (0: ACK, non-zero: NACK) |                                    |            |            |
| <b>Examples</b>                               | MIP Packet Header   |              |                  |                         | Command/Reply Fields |  |                                    | Checksum   |            |
|   | <i>Sync1</i>  | <i>Sync2</i> | <i>Desc. Set</i> | <i>Payload Length</i>   | <i>Field Length</i>  | <i>Field Desc.</i>   | <i>Field Data</i>                  | <i>MSB</i> | <i>LSB</i> |
| <i>Command</i>                                | 0x75  | 0x65         | 0x0C             | 2+Num                   | 2+Num                | 0x20   | Num_Bytes of raw RTCM2.3 data      | 0xXX       | 0xXX       |
| <i>Reply Field :<br/>ACK/NACK</i>             | 0x75  | 0x65         | 0x0C             | 0x04                    | 0x04                 | 0xF1   | Echo cmd: 0x20<br>Error code: 0x00 | 0xFF       | 0xEA       |
| <i>Copy-Paste version of the command: N/A</i> |   |              |                  |                         |                      |  |                                    |            |            |

### 4.3 Estimation Filter Commands

The 3DM command set is common to the LORD Sensing Inertial sensors that support the MIP packet protocol. Because of the unified set of commands, it is easy to migrate code from one inertial sensor to another.

#### 4.3.1 Reset Filter (0x0D, 0x01)

| 4.3.1 Reset Filter (0x0D, 0x01)                                 |  |              |                         |                       |  |                    |  |            |            |
|---|--|--------------|-------------------------|-----------------------|--|--------------------|--|------------|------------|
| <b>Description</b>  | Reset the filter to the initialize state.  |              |                         |                       |  |                    |  |            |            |
| <b>Notes</b>  | If the auto-initialization feature is disabled, the initial attitude or heading must be set in order to enter the run state after a reset. |              |                         |                       |  |                    |  |            |            |
| <b>Field Format</b>   | <i>Field Length</i>  |              | <i>Field Descriptor</i> |                       | <i>Field Data</i>  |                    |  |            |            |
| <i>Command</i>  | 0x02   |              | 0x01                    |                       | N/A  |                    |  |            |            |
| <i>Reply Field: ACK/NACK</i>                                    | 0x04   |              | 0xF1                    |                       | U8 - Echo the command byte<br>U8 - Error code (0: ACK, non-zero: NACK) |                    |  |            |            |
| <b>Example</b>  | MIP Packet Header  |              |                         |                       | Command/Reply Fields   |                    |  | Checksum   |            |
|   | <i>Sync1</i>   | <i>Sync2</i> | <i>Desc. Set</i>        | <i>Payload Length</i> | <i>Field Length</i>  | <i>Field Desc.</i> | <i>Field Data</i>                      | <i>MSB</i> | <i>LSB</i> |
| <i>Command</i>  | 0x75   | 0x65         | 0x0D                    | 0x02                  | 0x02   | 0x01               |  | 0xEC       | 0xF6       |
| <i>Reply Field: ACK/NACK</i>                                    | 0x75   | 0x65         | 0x0D                    | 0x04                  | 0x04   | 0xF1               | Command echo: 0x01<br>Error code: 0x00 | 0xE1       | 0xB2       |
| <i>Copy-Paste version of the command: "7565 0D02 0201 ECF6"</i> |  |              |                         |                       |  |                    |  |            |            |

## 4.3.2 Set Initial Attitude (0x0D, 0x02)

|   |  |              |                         |                       |  |                    |  |                 |            |
|---|--|--------------|-------------------------|-----------------------|--|--------------------|--|-----------------|------------|
| <b>Description</b>  | Set the initial attitude.  |              |                         |                       |  |                    |  |                 |            |
|   | <p>This command can only be issued in the “INIT” state and should be used with a good estimate of the vehicle attitude. The Euler Angles are the sensor body frame with respect to the local NED frame.</p> <p>The valid input ranges are as follows:</p> <p>Roll: [-<math>\pi</math>, <math>\pi</math>]<br/> Pitch: [-<math>\pi/2</math>, <math>\pi/2</math>]<br/> Yaw: [-<math>\pi</math>, <math>\pi</math>]</p> |              |                         |                       |  |                    |  |                 |            |
| <b>Field Format</b>   | <i>Field Length</i>  |              | <i>Field Descriptor</i> |                       | <i>Field Data</i>  |                    |  |                 |            |
| <i>Command</i>  | 0x0E   |              | 0x02                    |                       | Float - Roll (radians)<br>Float - Pitch (radians)<br>Float - Heading (radians) |                    |  |                 |            |
| <i>Reply Field :<br/>ACK/NACK</i>   | 0x04   |              | 0xF1                    |                       | U8 - echo the command byte<br>U8 - error code (0: ACK, non-zero: NACK)         |                    |  |                 |            |
| <b>Example</b>  | <b>MIP Packet Header</b>   |              |                         |                       | <b>Command/Reply Fields</b>  |                    |  | <b>Checksum</b> |            |
|   | <i>Sync1</i>   | <i>Sync2</i> | <i>Desc. Set</i>        | <i>Payload Length</i> | <i>Field Length</i>  | <i>Field Desc.</i> | <i>Field Data</i>  | <i>MSB</i>      | <i>LSB</i> |
| <i>Command</i>  | 0x75   | 0x65         | 0x0D                    | 0x0E                  | 0x0E   | 0x02               | Roll: 0x00000000<br>(0.0f)<br>Pitch: 0x00000000<br>(0.0f)<br>Heading: 0x00000000<br>(0x0f) | 0x05            | 0x6F       |
| <i>Reply Field:<br/>ACK/NACK</i>  | 0x75   | 0x65         | 0x0D                    | 0x04                  | 0x04   | 0xF1               | Command echo: 0x02<br>Error code: 0x00   | 0xE2            | 0xB4       |
| <i>Copy-Paste version of the command: "7565 0D0E0E02 0000 0000 0000 0000 0000 0000 0000 056F"</i> |  |              |                         |                       |  |                    |  |                 |            |

## 4.3.3 Set Initial Heading (0x0D, 0x03)

|   |   |              |                         |                       |  |                    |  |                 |            |
|---|---|--------------|-------------------------|-----------------------|--|--------------------|--|-----------------|------------|
| <b>Description</b>  | Set the initial heading angle.  |              |                         |                       |  |                    |  |                 |            |
|   | <p>This command can only be issued in the “INIT” state and should be used with a good estimation of Heading. The device will use this value in conjunction with the output of the accelerometers to determine the initial attitude estimate. The Euler Angles are the sensor body frame with respect to the local NED frame.</p> <p>The valid input range for heading is [-π, π].</p> |              |                         |                       |  |                    |  |                 |            |
| <b>Field Format</b>   | <i>Field Length</i>   |              | <i>Field Descriptor</i> |                       | <i>Field Data</i>  |                    |  |                 |            |
| <i>Command</i>  | 0x06  |              | 0x03                    |                       | Float - Heading (radians)  |                    |  |                 |            |
| <i>Reply Field:<br/>ACK/NACK</i>  | 0x04  |              | 0xF1                    |                       | U8 - Echo the command byte<br>U8 - Error code (0: ACK, non-zero: NACK) |                    |  |                 |            |
| <b>Example</b>  | <b>MIP Packet Header</b>  |              |                         |                       | <b>Command/Reply Fields</b>  |                    |  | <b>Checksum</b> |            |
|   | <i>Sync1</i>  | <i>Sync2</i> | <i>Desc. Set</i>        | <i>Payload Length</i> | <i>Field Length</i>  | <i>Field Desc.</i> | <i>Field Data</i>                      | <i>MSB</i>      | <i>LSB</i> |
| <i>Command</i>  | 0x75  | 0x65         | 0x0D                    | 0x06                  | 0x06   | 0x03               | Heading: 0x00000000<br>(0x0f)          | 0xF6            | 0xE4       |
| <i>Reply Field:<br/>ACK/NACK</i>  | 0x75  | 0x65         | 0x0D                    | 0x04                  | 0x04   | 0xF1               | Command echo: 0x03<br>Error code: 0x00 | 0xE3            | 0xB6       |
| <i>Copy-Paste version of the command: "7565 0D06 0603 0000 0000 F6E4"</i> |   |              |                         |                       |  |                    |  |                 |            |

### 4.3.4 Vehicle Dynamics Mode (0x0D, 0x10)

| <b>Description</b>                 | <p>Set, read, or save the vehicle dynamics mode. For all functions except 0x01 (use new settings), the new dynamics mode value is ignored.</p> <p>Possible function selector values:</p> <ul style="list-style-type: none"> <li>0x01 - Apply new settings</li> <li>0x02 - Read back current settings.</li> <li>0x03 - Save current settings as startup settings</li> <li>0x04 - Load saved startup settings</li> <li>0x05 - Load factory default settings</li> </ul> <p>Possible Modes:</p> <table border="1"> <thead> <tr> <th>Mode</th> <th>Use</th> <th>Altitude Limits</th> <th>Velocity Limits</th> </tr> </thead> <tbody> <tr> <td>0x01 - Portable (default)</td> <td>Applications with low acceleration</td> <td>12,000 m</td> <td>Horizontal - 310 m/s<br/>Vertical - 50 m/s</td> </tr> <tr> <td>0x02 - Automotive</td> <td>Low vertical acceleration, wheeled-vehicle dynamics</td> <td>6,000 m</td> <td>Horizontal - 84 m/s<br/>Vertical - 15 m/s</td> </tr> <tr> <td>0x03 - Airborne</td> <td>Airborne application up to 2 Gs</td> <td>50,000 m</td> <td>Horizontal - 250 m/s<br/>Vertical - 100 m/s</td> </tr> <tr> <td>0x04 - Airborne (High G)</td> <td>Airborne application up to 4 Gs</td> <td>50,000 m</td> <td>Horizontal - 250 m/s<br/>Vertical - 100 m/s</td> </tr> </tbody> </table> |                         |  |                       |                      |                    |                   |            |            | Mode | Use | Altitude Limits | Velocity Limits | 0x01 - Portable (default) | Applications with low acceleration | 12,000 m | Horizontal - 310 m/s<br>Vertical - 50 m/s | 0x02 - Automotive | Low vertical acceleration, wheeled-vehicle dynamics | 6,000 m | Horizontal - 84 m/s<br>Vertical - 15 m/s | 0x03 - Airborne | Airborne application up to 2 Gs | 50,000 m | Horizontal - 250 m/s<br>Vertical - 100 m/s | 0x04 - Airborne (High G) | Airborne application up to 4 Gs | 50,000 m | Horizontal - 250 m/s<br>Vertical - 100 m/s |
|------------------------------------|---|-------------------------|--|-----------------------|----------------------|--------------------|-------------------|------------|------------|------|-----|-----------------|-----------------|---------------------------|------------------------------------|----------|---|-------------------|---|---------|--|-----------------|---------------------------------|----------|--|--------------------------|---------------------------------|----------|--|
|                                    | Mode  | Use                     | Altitude Limits  | Velocity Limits       |                      |                    |                   |            |            |      |     |                 |                 |                           |                                    |          |   |                   |   |         |  |                 |                                 |          |  |                          |                                 |          |  |
| 0x01 - Portable (default)          | Applications with low acceleration  | 12,000 m                | Horizontal - 310 m/s<br>Vertical - 50 m/s                              |                       |                      |                    |                   |            |            |      |     |                 |                 |                           |                                    |          |   |                   |   |         |  |                 |                                 |          |  |                          |                                 |          |  |
| 0x02 - Automotive                  | Low vertical acceleration, wheeled-vehicle dynamics   | 6,000 m                 | Horizontal - 84 m/s<br>Vertical - 15 m/s                               |                       |                      |                    |                   |            |            |      |     |                 |                 |                           |                                    |          |   |                   |   |         |  |                 |                                 |          |  |                          |                                 |          |  |
| 0x03 - Airborne                    | Airborne application up to 2 Gs   | 50,000 m                | Horizontal - 250 m/s<br>Vertical - 100 m/s                             |                       |                      |                    |                   |            |            |      |     |                 |                 |                           |                                    |          |   |                   |   |         |  |                 |                                 |          |  |                          |                                 |          |  |
| 0x04 - Airborne (High G)           | Airborne application up to 4 Gs   | 50,000 m                | Horizontal - 250 m/s<br>Vertical - 100 m/s                             |                       |                      |                    |                   |            |            |      |     |                 |                 |                           |                                    |          |   |                   |   |         |  |                 |                                 |          |  |                          |                                 |          |  |
| <b>Field Format</b>                | <i>Field Length</i>   | <i>Field Descriptor</i> | <i>Field Data</i>  |                       |                      |                    |                   |            |            |      |     |                 |                 |                           |                                    |          |   |                   |   |         |  |                 |                                 |          |  |                          |                                 |          |  |
| <i>Command</i>                     | 0x04  | 0x10                    | U8 - Function Selector<br>U8 - New Dynamics Mode                       |                       |                      |                    |                   |            |            |      |     |                 |                 |                           |                                    |          |   |                   |   |         |  |                 |                                 |          |  |                          |                                 |          |  |
| <i>Reply Field 1: ACK/NACK</i>     | 0x04  | 0xF1                    | U8 - echo the command byte<br>U8 - error code (0: ACK, non-zero: NACK) |                       |                      |                    |                   |            |            |      |     |                 |                 |                           |                                    |          |   |                   |   |         |  |                 |                                 |          |  |                          |                                 |          |  |
| <i>Reply Field 2: Function = 2</i> | 0x03  | 0x80                    | U8 - Current Dynamics Mode   |                       |                      |                    |                   |            |            |      |     |                 |                 |                           |                                    |          |   |                   |   |         |  |                 |                                 |          |  |                          |                                 |          |  |
| <b>Example</b>                     | MIP Packet Header   |                         |  |                       | Command/Reply Fields |                    |                   | Checksum   |            |      |     |                 |                 |                           |                                    |          |   |                   |   |         |  |                 |                                 |          |  |                          |                                 |          |  |
|                                    | <i>Sync1</i>  | <i>Sync2</i>            | <i>Desc. Set</i>   | <i>Payload Length</i> | <i>Field Length</i>  | <i>Field Desc.</i> | <i>Field Data</i> | <i>MSB</i> | <i>LSB</i> |      |     |                 |                 |                           |                                    |          |   |                   |   |         |  |                 |                                 |          |  |                          |                                 |          |  |

|   |      |      |      |      |      |      |   |      |      |
|---|------|------|------|------|------|------|---|------|------|
| <i>Command</i>  | 0x75 | 0x65 | 0x0D | 0x04 | 0x04 | 0x10 | Fctn (Apply): 0x01<br>Mode (Portable): 0x01 | 0x01 | 0x10 |
| <i>Reply Field:<br/>ACK/NACK</i>                                    | 0x75 | 0x65 | 0x0D | 0x04 | 0x04 | 0xF1 | Command echo: 0x10<br>Error code: 0x00      | 0xF0 | 0xD0 |
| <i>Copy-Paste version of the command: "7565 0C04 0410 01010110"</i> |      |      |      |      |      |      |   |      |      |

### 4.3.5 Sensor to Vehicle Frame Rotation (0x0D, 0x11)

|                                    |  |                         |  |
|------------------------------------|--|-------------------------|--|
| <b>Description</b>                 | <p>Set the sensor to vehicle frame transformation matrix using Roll, Pitch, and Yaw Euler angles. These angles define the rotation from the sensor body frame to the fixed vehicle frame.</p> <p>Possible function selector values:</p> <ul style="list-style-type: none"> <li>0x01 - Use new settings</li> <li>0x02 - Read back current settings</li> <li>0x03 - Save current settings as startup settings</li> <li>0x04 - Load saved startup settings</li> <li>0x05 - Reset to factory default settings</li> </ul> <p>This transformation affects the following output quantities:</p> <p><b>IMU:</b></p> <ul style="list-style-type: none"> <li>Scaled Acceleration</li> <li>Scaled Gyro</li> <li>Scaled Magnetometer</li> <li>Delta Theta</li> <li>Delta Velocity</li> </ul> <p><b>Estimation Filter:</b></p> <ul style="list-style-type: none"> <li>Estimated Orientation, Quaternion</li> <li>Estimated Orientation, Matrix</li> <li>Estimated Orientation, Euler Angles</li> <li>Estimated Linear Acceleration</li> <li>Estimated Angular Rate</li> <li>Estimated Gravity Vector</li> </ul> |                         |  |
| <b>Field Format</b>                | <i>Field Length</i>  | <i>Field Descriptor</i> | <i>Field Data</i>  |
| <i>Command</i>                     | 0x0F   | 0x11                    | U8 - Function Selector<br>Float - Roll Angle [-PI, PI] radians<br>Float - Pitch Angle (-PI/2, PI/2) radians<br>Float - Yaw Angle [-PI, PI] radians |
| <i>Reply Field 1:<br/>ACK/NACK</i> | 0x04   | 0xF1                    | U8 - echo the command descriptor<br>U8 - error code (0: ACK, non-zero: NACK)   |

|  |                          |              |                  |                       |  |                    |   |                 |            |
|--|--------------------------|--------------|------------------|-----------------------|--|--------------------|---|-----------------|------------|
| <i>Reply Field 2:<br/>Function = 2</i>   | 0x0E                     |              | 0x81             |                       | Float - Roll Angle (radians)<br>Float - Pitch Angle (radians)<br>Float - Yaw Angle (radians) |                    |   |                 |            |
| <b>Example</b>   | <b>MIP Packet Header</b> |              |                  |                       | <b>Command/Reply Fields</b>  |                    |   | <b>Checksum</b> |            |
|  | <i>Sync1</i>             | <i>Sync2</i> | <i>Desc. Set</i> | <i>Payload Length</i> | <i>Field Length</i>  | <i>Field Desc.</i> | <i>Field Data</i>   | <i>MSB</i>      | <i>LSB</i> |
| <i>Command</i>   | 0x75                     | 0x65         | 0x0D             | 0x0F                  | 0x0F   | 0x11               | Fctn (Apply): 0x01<br>Roll: 0x00000000 (0.0f)<br>Pitch: 0x00000000 (0.0f)<br>Yaw: 0x00000000 (0.0f) | 0x17            | 0x72       |
| <i>Reply Field :<br/>ACK/NACK</i>  | 0x75                     | 0x65         | 0x0D             | 0x04                  | 0x04   | 0xF1               | Command echo: 0x11<br>Error code: 0x00  | 0xF1            | 0xD2       |
| <i>Copy-Paste version of the command: "7565 0D0F 0F11 0100 0000 0000 0000 0000 0000 0017 72"</i> |                          |              |                  |                       |  |                    |   |                 |            |



### 4.3.6 Sensor to Vehicle Frame Offset (0x0D, 0x12)

|  |  |                     |                         |                       |  |                    |  |                 |            |
|--|--|---------------------|-------------------------|-----------------------|--|--------------------|--|-----------------|------------|
| <b>Description</b>                     | <p>Set the sensor to vehicle frame offset, expressed in the sensor frame.</p> <p>This is a simple vehicle offset and not a lever arm offset. This offset does not compensate for inertial effects of being offset from the center of rotation/gravity of the vehicle. It simply adds the offset to the position output to accurately represent the physical location of the center of the vehicle. Please reference the device Theory of Operation for more information.</p> <p>Possible function selector values:</p> <ul style="list-style-type: none"> <li>0x01 - Use new settings</li> <li>0x02 - Read back current settings.</li> <li>0x03 - Save current settings as startup settings</li> <li>0x04 - Load saved startup settings</li> <li>0x05 - Reset to factory default settings</li> </ul> <p>This transformation affects the following output quantities:</p> <p style="padding-left: 40px;">Estimated LLH Position</p> <p>The offset vector magnitude is limited to 10 meters.</p> |                     |                         |                       |  |                    |  |                 |            |
|  | <b>Field Format</b>  | <i>Field Length</i> | <i>Field Descriptor</i> |                       |  | <i>Field Data</i>  |  |                 |            |
| <i>Command</i>                         | 0x0F   | 0x12                |                         |                       | U8 - Function Selector<br>Float - X (meters, sensor bodyframe)<br>Float - Y (meters, sensor bodyframe)<br>Float - Z (meters, sensor bodyframe) |                    |  |                 |            |
| <i>Reply Field 1:<br/>ACK/ NACK</i>    | 0x04   | 0xF1                |                         |                       | U8 - echo the command descriptor<br>U8 - error code (0: ACK, non-zero: NACK)   |                    |  |                 |            |
| <i>Reply Field 2:<br/>Function = 2</i> | 0x0E   | 0x82                |                         |                       | Float - X (meters, sensor bodyframe)<br>Float - Y (meters, sensor bodyframe)<br>Float - Z (meters, sensor bodyframe)                           |                    |  |                 |            |
| <b>Example</b>                         | <b>MIP Packet Header</b>   |                     |                         |                       | <b>Command/Reply Fields</b>  |                    |  | <b>Checksum</b> |            |
|  | <i>Sync1</i>   | <i>Sync2</i>        | <i>Desc. Set</i>        | <i>Payload Length</i> | <i>Field Length</i>  | <i>Field Desc.</i> | <i>Field Data</i>                                | <i>MSB</i>      | <i>LSB</i> |
| <i>Command:</i>                        | 0x75   | 0x65                | 0x0D                    | 0x0F                  | 0x0F   | 0x12               | Fctn<br>(Apply): 0x01<br>X: 0x00000000<br>(0.0f) | 0x18            | 0x80       |

|  |      |      |      |      |      |      |  |      |      |
|--|------|------|------|------|------|------|--|------|------|
|  |      |      |      |      |      |      | Y: 0x00000000<br>(0.0f)<br>Z: 0x00000000<br>(0x0f) |      |      |
| <i>Reply Field:<br/>ACK/NACK</i>   | 0x75 | 0x65 | 0x0D | 0x04 | 0x04 | 0xF1 | Command echo: 0x12<br>Error code: 0x00             | 0xF2 | 0xD4 |
| <i>Copy-Paste version of the command: "7565 0D0F 0F12 0100 0000 0000 0000 0000 0000 0018 80"</i> |      |      |      |      |      |      |  |      |      |

## 4.3.7 Antenna Offset (0x0D, 0x13)

|  |   |                         |                  |                       |  |                    |  |            |            |
|--|---|-------------------------|------------------|-----------------------|--|--------------------|--|------------|------------|
| <b>Description</b>   | Set the sensor to antenna offset, expressed in the sensor frame from the sensor inertial origin to the GNSS antenna RF center.  |                         |                  |                       |  |                    |  |            |            |
|  | Always enter measurements relative to the sensor frame, not the vehicle frame.  |                         |                  |                       |  |                    |  |            |            |
| <b>Description</b>   | Possible function selector values:  |                         |                  |                       |  |                    |  |            |            |
|  | <ul style="list-style-type: none"> <li>0x01 - Use new settings</li> <li>0x02 - Read back current settings.</li> <li>0x03 - Save current settings as startup settings</li> <li>0x04 - Load saved startup settings</li> <li>0x05 - Reset to factory default settings</li> </ul> |                         |                  |                       |  |                    |  |            |            |
| The offset vector magnitude is limited to 10 meters.   |   |                         |                  |                       |  |                    |  |            |            |
| <b>Field Format</b>  | <i>Field Length</i>   | <i>Field Descriptor</i> |                  |                       | <i>Field Data</i>  |                    |  |            |            |
| <i>Command</i>   | 0x0F  | 0x13                    |                  |                       | U8 - Function Selector<br>Float - X (meters, sensor bodyframe)<br>Float - Y (meters, sensor bodyframe)<br>Float - Z (meters, sensor bodyframe) |                    |  |            |            |
| <i>Reply Field 1:<br/>ACK/NACK</i>   | 0x04  | 0xF1                    |                  |                       | U8 - echo the command descriptor<br>U8 - error code (0: ACK, non-zero: NACK)   |                    |  |            |            |
| <i>Reply Field 2:<br/>Function = 2</i>   | 0x0E  | 0x83                    |                  |                       | Float - X (meters, sensor bodyframe)<br>Float - Y (meters, sensor bodyframe)<br>Float - Z (meters, sensor bodyframe)                           |                    |  |            |            |
| <b>Example</b>   | MIP Packet Header   |                         |                  |                       | Command/Reply Fields   |                    |  | Checksum   |            |
|  | <i>Sync1</i>  | <i>Sync2</i>            | <i>Desc. Set</i> | <i>Payload Length</i> | <i>Field Length</i>  | <i>Field Desc.</i> | <i>Field Data</i>  | <i>MSB</i> | <i>LSB</i> |
| <i>Command</i>   | 0x75  | 0x65                    | 0x0D             | 0x0F                  | 0x0F   | 0x13               | Fctn (Apply): 0x01<br>X: 0x00000000 (0.0f)<br>Y: 0x00000000 (0.0f)<br>Z: 0x00000000 (0x0f) | 0x19       | 0x8E       |
| <i>Reply Field:<br/>ACK/NACK</i>   | 0x75  | 0x65                    | 0x0D             | 0x04                  | 0x04   | 0xF1               | Command echo: 0x13<br>Error code: 0x00   | 0xF3       | 0xD6       |
| <i>Copy-Paste version of the command: "7565 0D0F 0F13 0100 0000 0000 0000 0000 0000 0019 8E"</i> |   |                         |                  |                       |  |                    |  |            |            |

## 4.3.8 Estimation Control Flags (0x0D, 0x14)

|  |  |              |                         |                       |  |                    |   |            |            |
|--|--|--------------|-------------------------|-----------------------|--|--------------------|---|------------|------------|
| <b>Description</b>                     | Controls which parameters are estimated by the Kalman Filter.  |              |                         |                       |  |                    |   |            |            |
|  | Possible function selector values:<br>0x01 - Use new settings<br>0x02 - Read back current settings.<br>0x03 - Save current settings as startup settings<br>0x04 - Load saved startup settings<br>0x05 - Reset to factory default settings<br><br>Available Flags:<br>0x0001 - Enable Gyro Bias Estimation (Recommended)<br>0x0002 - Enable Accel Bias Estimation (Recommended)<br>0x0004 - Enable Gyro Scale Factor Estimation (Optional)<br>0x0008 - Enable Accel Scale Factor Estimation (Optional)<br>0x0010 - Enable GNSS Antenna Offset Estimation (Optional)<br>0x0020 - Enable Hard Iron Auto Calibration (Optional)<br>0x0040 - Enable Soft Iron Auto Calibration (Optional)<br><br>Examples:<br>0x0001 - Enable Gyro Bias Estimation<br>0x0063 - Enable Gyro and Accel Bias Estimation and Mag Auto Cal |              |                         |                       |  |                    |   |            |            |
| <b>Field Format</b>                    | <i>Field Length</i>  |              | <i>Field Descriptor</i> |                       | <i>Field Data</i>  |                    |   |            |            |
| <i>Command</i>                         | 0x05   |              | 0x14                    |                       | U8 - Function Selector<br>U16 - Estimation Control Flags                     |                    |   |            |            |
| <i>Reply Field 1:<br/>ACK/ NACK</i>    | 0x04   |              | 0xF1                    |                       | U8 - Echo the command descriptor<br>U8 - Error code (0: ACK, non-zero: NACK) |                    |   |            |            |
| <i>Reply Field 2:<br/>Function = 2</i> | 0x04   |              | 0x84                    |                       | U16 - Estimation Control Flags   |                    |   |            |            |
| <b>Example</b>                         | MIP Packet Header  |              |                         |                       | Command/Reply Fields   |                    |   | Checksum   |            |
|  | <i>Sync1</i>   | <i>Sync2</i> | <i>Desc. Set</i>        | <i>Payload Length</i> | <i>Field Length</i>  | <i>Field Desc.</i> | <i>Field Data</i>   | <i>MSB</i> | <i>LSB</i> |
| <i>Command:</i>                        | 0x75   | 0x65         | 0x0D                    | 0x05                  | 0x05   | 0x14               | Fctn (Apply):<br>0x01<br>0xFFFF<br>Flags: (enable all states) | 0x04       | 0x27       |

|   |      |      |      |      |      |      |                                    |      |      |
|---|------|------|------|------|------|------|------------------------------------|------|------|
| <i>Reply Field:<br/>ACK/NACK</i>  | 0x75 | 0x65 | 0x0D | 0x04 | 0x04 | 0xF1 | Echo cmd: 0x14<br>Error code: 0x00 | 0xF4 | 0xD8 |
| <i>Copy-Paste version of the command: "7565 0D05 0514 01FF FF04 27"</i> |      |      |      |      |      |      |                                    |      |      |

### 4.3.9 GNSS Source Control (0x0D, 0x15)

|  |   |                         |                  |                       |  |                    |  |            |            |
|--|---|-------------------------|------------------|-----------------------|--|--------------------|--|------------|------------|
| <b>Description</b>                     | <p>Control the source of GNSS information used to update the Kalman Filter.</p> <p>Possible function selector values:</p> <ul style="list-style-type: none"> <li>0x01 - Use new settings</li> <li>0x02 - Read back current settings.</li> <li>0x03 - Save current settings as startup settings</li> <li>0x04 - Load saved startup settings</li> <li>0x05 - Reset to factory default settings</li> </ul> <p>Possible GNSS Source values:</p> <ul style="list-style-type: none"> <li>0x01 - Internal GNSS</li> <li>0x02 - External GNSS (Requires user to provide GNSS information via the "External GNSS Update" command)</li> </ul> |                         |                  |                       |  |                    |  |            |            |
| <b>Notes</b>                           | <p>Changing the GNSS source while the sensor is in the "running" state will temporarily place it back in the "init" state until the new source of GNSS data is received.</p> <p>Angle uncertainties of 0.0 will be NACK'd.</p>  |                         |                  |                       |  |                    |  |            |            |
| <b>Field Format</b>                    | <i>Field Length</i>   | <i>Field Descriptor</i> |                  |                       | <i>Field Data</i>  |                    |  |            |            |
| <i>Command</i>                         | 0x04  | 0x15                    |                  |                       | U8 - Function Selector<br>U8 - GNSS Source                                   |                    |  |            |            |
| <i>Reply Field 1:<br/>ACK/NACK</i>     | 0x04  | 0xF1                    |                  |                       | U8 - Echo the command descriptor<br>U8 - Error code (0: ACK, non-zero: NACK) |                    |  |            |            |
| <i>Reply Field 2:<br/>Function = 2</i> | 0x03  | 0x86                    |                  |                       | U8 - GNSS Source   |                    |  |            |            |
| <b>Example</b>                         | MIP Packet Header   |                         |                  |                       | Command/Reply Fields   |                    |  | Checksum   |            |
|  | <i>Sync1</i>  | <i>Sync2</i>            | <i>Desc. Set</i> | <i>Payload Length</i> | <i>Field Length</i>  | <i>Field Desc.</i> | <i>Field Data</i>                                | <i>MSB</i> | <i>LSB</i> |
| <i>Command</i>                         | 0x75  | 0x65                    | 0x0D             | 0x04                  | 0x04   | 0x15               | Fctn (Apply): 0x01<br>Source: 0x02<br>(External) | 0x07       | 0x20       |

|  |      |      |      |      |      |      | GNSS)                              |      |      |
|--|------|------|------|------|------|------|------------------------------------|------|------|
| <i>Reply Field:<br/>ACK/NACK</i>                                     | 0x75 | 0x65 | 0x0D | 0x04 | 0x04 | 0xF1 | Echo cmd: 0x15<br>Error code: 0x00 | 0xF5 | 0xDA |
| <i>Copy-Paste version of the command: "7565 0D04 0415 0102 0720"</i> |      |      |      |      |      |      |                                    |      |      |

#### 4.3.10 External GNSS Update (0x0D, 0x16)

|                                 |  |                         |                  |                       |  |                    |  |            |            |
|---------------------------------|--|-------------------------|------------------|-----------------------|--|--------------------|--|------------|------------|
| <b>Description</b>              | <p>Trigger a filter update step using external GNSS information.</p> <p>GNSS source control must be set to external for this command to update the filter; it will be ignored/NACK'd otherwise. The maximum rate for this message is 4 Hz.</p> |                         |                  |                       |  |                    |  |            |            |
| <b>Field Format</b>             | <i>Field Length</i>  | <i>Field Descriptor</i> |                  |                       | <i>Field Data</i>  |                    |  |            |            |
| <i>Command</i>                  | 0x48   | 0x16                    |                  |                       | Double - GPS Time of Week (seconds)<br>U16 - GPS Week Number<br>Double - Latitude (deg)<br>Double - Longitude (deg)<br>Double - Altitude above WGS84 Ellipsoid (m)<br><br>Float - North Velocity (m/s)<br>Float - East Velocity (m/s)<br>Float - Down Velocity (m/s)<br><br>Float - North Position Uncertainty (m, 1-sigma)<br>Float - East Position Uncertainty (m, 1-sigma)<br>Float - Down Position Uncertainty (m, 1-sigma)<br><br>Float - North Velocity Uncertainty (m/s, 1-sigma)<br>Float - East Velocity Uncertainty (m/s, 1-sigma)<br>Float - Down Velocity Uncertainty (m/s, 1-sigma) |                    |  |            |            |
| <i>Reply Field<br/>ACK/NACK</i> | 0x04   | 0xF1                    |                  |                       | U8 - echo the command descriptor<br>U8 - error code (0: ACK, non-zero: NACK)   |                    |  |            |            |
| <b>Example</b>                  | MIP Packet Header  |                         |                  |                       | Command/Reply Fields   |                    |  | Checksum   |            |
|                                 | <i>Sync1</i>   | <i>Sync2</i>            | <i>Desc. Set</i> | <i>Payload Length</i> | <i>Field Length</i>  | <i>Field Desc.</i> | <i>Field Data</i>  | <i>MSB</i> | <i>LSB</i> |
| <i>Command</i>                  | 0x75   | 0x65                    | 0x0D             | 0x48                  | 0x48   | 0x16               | GPS Tow: 0.0d<br>GPS Week: 0x0000<br>Latitude: 0.0d<br>Longitude: 0.0d | 0xXX       | 0xXX       |

|   |             |             |             |             |             |             |   |             |             |
|---|-------------|-------------|-------------|-------------|-------------|-------------|---|-------------|-------------|
|   |             |             |             |             |             |             | Height: <b>0.0d</b><br>Vel North: <b>0.0f</b><br>Vel East: <b>0.0f</b><br>Vel Down: <b>0.0f</b><br>Pos Sigma (N): <b>0.5f</b><br>Pos Sigma (E): <b>0.5f</b><br>Pos Sigma (D): <b>0.5f</b><br>Vel Sigma (N): <b>0.1f</b><br>Vel Sigma (E): <b>0.1f</b><br>Vel Sigma (D): <b>0.1f</b> |             |             |
| <i>Reply Field:</i><br><i>ACK/NACK</i>        | <b>0x75</b> | <b>0x65</b> | <b>0x0D</b> | <b>0x04</b> | <b>0x04</b> | <b>0xF1</b> | Echo cmd: <b>0x16</b><br>Error code: <b>0x00</b>  | <b>0xF6</b> | <b>0xDC</b> |
| <i>Copy-Paste version of the command: N/A</i> |             |             |             |             |             |             |   |             |             |

### 4.3.11 Heading Update Control (0x0D, 0x18)

|                    |  |
|--------------------|--|
| <b>Description</b> | <p>Select the source for aiding heading updates to the Kalman Filter.</p> <p><i>Possible function selector values:</i></p> <ul style="list-style-type: none"> <li>0x01 - Use new settings</li> <li>0x02 - Read back current settings.</li> <li>0x03 - Save current settings as startup settings</li> <li>0x04 - Load saved startup settings</li> <li>0x05 - Reset to factory default settings</li> </ul> <p><i>Possible Enable Option values:</i></p> <ul style="list-style-type: none"> <li>0x00 - No heading aids<sup>3</sup></li> <li>0x01 - Use the Internal Magnetometer for heading updates</li> <li>0x02 - Use the Internal GNSS velocity vector for heading updates<sup>1,2</sup></li> <li>0x03 - Use external heading messages for heading updates</li> <li>0x04 - Use the internal GNSS velocity vector AND magnetometer for heading updates</li> <li>0x05 - Use the internal GNSS velocity vector AND external heading messages for heading updates</li> <li>0x06 - Use the internal magnetometer AND external heading messages for heading updates</li> <li>0x07 - Use the internal GNSS velocity vector AND magnetometer AND external heading messages for heading updates</li> </ul> |
| <b>Notes</b>       | <p>1. To use the Internal GNSS velocity vector for heading updates, the target application must have no (or minimal) side-slip (for example</p>  |

## 4.3.11 Heading Update Control (0x0D, 0x18)

this option may be used in most ground vehicle applications).

2. When using the GNSS velocity vector for heading updates, the X-axis of the vehicle transform must be co-aligned with the direction of travel of the vehicle.
3. When option 0 is selected, the heading estimate will still converge if GNSS is available and the device changes velocity with sufficient rate and frequency. In this case, heading accuracy will depend on the average acceleration rate. The heading estimate may drift when the unit is stationary or maintains both constant speed and course over ground. You should use this option when the use of the magnetometer or external heading input are not possible and the device will undergo slip (for example, fixed wing air- craft traveling in crosswinds).

| Field Format   | Field Length      |              | Field Descriptor | Field Data   |                      |                    |                                    |            |            |
|--|-------------------|--------------|------------------|--|----------------------|--------------------|------------------------------------|------------|------------|
| <i>Command</i>   | 0x04              |              | 0x18             | U8 - Function Selector<br>U8 - Enable Flag                                   |                      |                    |                                    |            |            |
| <i>Reply Field 1:<br/>ACK/ NACK</i>                                  | 0x04              |              | 0xF1             | U8 - Echo the command descriptor<br>U8 - Error code (0: ACK, non-zero: NACK) |                      |                    |                                    |            |            |
| <i>Reply Field 2:<br/>Function = 2</i>                               | 0x03              |              | 0x87             | U8 - Enable Flag   |                      |                    |                                    |            |            |
| Example  | MIP Packet Header |              |                  |  | Command/Reply Fields |                    |                                    | Checksum   |            |
|  | <i>Sync1</i>      | <i>Sync2</i> | <i>Desc. Set</i> | <i>Payload Length</i>  | <i>Field Length</i>  | <i>Field Desc.</i> | <i>Field Data</i>                  | <i>MSB</i> | <i>LSB</i> |
| <i>Command</i>   | 0x75              | 0x65         | 0x0D             | 0x04   | 0x04                 | 0x18               | Apply: 0x01<br>Enable: 0x01        | 0x09       | 0x28       |
| <i>Reply Field 1:<br/>ACK/NACK</i>                                   | 0x75              | 0x65         | 0x0D             | 0x04   | 0x04                 | 0xF1               | Echo cmd: 0x18<br>Error code: 0x00 | 0xF8       | 0xE0       |
| <i>Copy-Paste version of the command: "7565 0D04 0418 0101 0928"</i> |                   |              |                  |  |                      |                    |                                    |            |            |



## 4.3.12 External Heading Update (0x0D, 0x17)

|   |   |                         |                  |                       |  |                    |   |            |            |
|---|---|-------------------------|------------------|-----------------------|--|--------------------|---|------------|------------|
| <b>Description</b>                            | Trigger a filter update step using external heading information.  |                         |                  |                       |  |                    |   |            |            |
|   | <p><b>The heading must be the sensor frame with respect to the NED frame.</b></p> <p>The heading update control must be set to external for this command to update the filter; it will be ignored/NACK'd otherwise. The maximum rate for this message is 20 Hz.</p> <p>Angle uncertainties of 0.0 will be NACK'd.</p> <p>Possible Heading Type Commands:<br/> 0x01 - True Heading*<br/> 0x02 - Magnetic Heading**</p> |                         |                  |                       |  |                    |   |            |            |
| <b>Notes</b>                                  | <ul style="list-style-type: none"> <li>· On the -25 model, if the declination source (0x0D, 0x43) is not valid, <b>true heading updates</b> will be NACK'd.</li> <li>· On the -45 model, if the declination source is invalid, <b>magnetic heading updates</b> will be NACK'd.</li> </ul>   |                         |                  |                       |  |                    |   |            |            |
| <b>Field Format</b>                           | <i>Field Length</i>   | <i>Field Descriptor</i> |                  |                       | <i>Field Data</i>  |                    |   |            |            |
| <i>Command</i>                                | 0x0B  | 0x17                    |                  |                       | Float - Heading Angle (radians, true north, +- PI)<br>Float - Heading Angle Uncertainty (radians, 1-sigma)<br>U8 - Heading type (1 - true, 2 - magnetic) |                    |   |            |            |
| <i>Reply Field:<br/>ACK/NACK</i>              | 0x04  | 0xF1                    |                  |                       | U8 - Echo the command byte<br>U8 - Error code (0: ACK, non-zero: NACK)   |                    |   |            |            |
| <b>Example</b>                                | MIP Packet Header   |                         |                  |                       | Command/Reply Fields   |                    |   | Checksum   |            |
|   | <i>Sync1</i>  | <i>Sync2</i>            | <i>Desc. Set</i> | <i>Payload Length</i> | <i>Field Length</i>  | <i>Field Desc.</i> | <i>Field Data</i>   | <i>MSB</i> | <i>LSB</i> |
| <i>Command</i>                                | 0x75  | 0x65                    | 0x0D             | 0x0B                  | 0x0B   | 0x17               | Angle: 0.1f<br>Angle<br>Sigma: 0.1f<br>Heading 0x01<br>Type: (True) | 0xFF       | 0xFF       |
| <i>Reply Field:<br/>ACK/NACK</i>              | 0x75  | 0x65                    | 0x0D             | 0x04                  | 0x04   | 0xF1               | Echo cmd: 0x17<br>Error code: 0x00                                  | 0xF7       | 0xDE       |
| <i>Copy-Paste version of the command: N/A</i> |   |                         |                  |                       |  |                    |   |            |            |

### 4.3.13 External Heading Update with Timestamp (0x0D, 0x1F)

|                                       |  |                                |                         |                              |  |                           |   |                   |                   |
|---------------------------------------|--|--------------------------------|-------------------------|------------------------------|--|---------------------------|---|-------------------|-------------------|
| <p><b>Description</b></p>             | <p>Trigger a filter update step using external heading information that is time-tagged with a specific GPS Time.</p> <p>This is more accurate than the External Heading Update (0x0D, 0x17) and should be used in applications where the vehicle heading experiences high angular rate, which may cause significant error in the applied measurement due to the sampling, transmission, and processing time required for the command. Accurate time-stamping of the heading information is important. The maximum rate for this message is 20 Hz.</p> <p>Angle uncertainties of 0.0 will be NACK'd.</p> <p>Possible Heading Type Commands:</p> <p style="padding-left: 40px;">0x01 - True Heading*</p> <p style="padding-left: 40px;">0x02 - Magnetic Heading*</p> <p><b>The heading must be the sensor frame with respect to the NED frame.</b></p> |                                |                         |                              |  |                           |   |                   |                   |
| <p><b>Notes</b></p>                   | <ul style="list-style-type: none"> <li>⌋ On the -25 model, if the declination source (0x0D, 0x43) is not valid, <b>true heading updates</b> will be NACK'd.</li> <li>⌋ On the -45 model, if the declination source is invalid, <b>magnetic heading updates</b> will be NACK'd.</li> </ul>  |                                |                         |                              |  |                           |   |                   |                   |
| <p><b>Field Format</b></p>            | <p><i>Field Length</i></p>   | <p><i>Field Descriptor</i></p> |                         |                              | <p><i>Field Data</i></p>   |                           |   |                   |                   |
| <p><i>Command</i></p>                 | <p>0x15</p>  | <p>0x1F</p>                    |                         |                              | <p>Double - GNSS TOW (time-of-week, seconds)<br/>                 U16 - GNSS week number<br/>                 Float - Heading Angle (radians, true north, +- PI)<br/>                 Float - Heading Angle Uncertainty (radians, 1-sigma)<br/>                 U8 - Heading type (1 - true, 2 - magnetic)</p> |                           |   |                   |                   |
| <p><i>Reply Field : ACK/ NACK</i></p> | <p>0x04</p>  | <p>0xF1</p>                    |                         |                              | <p>U8 - Echo the command descriptor<br/>                 U8 - Error code (0: ACK, non-zero: NACK)</p>  |                           |   |                   |                   |
| <p><b>Example</b></p>                 | <p>MIP Packet Header</p>   |                                |                         |                              | <p>Command/Reply Fields</p>  |                           |   | <p>Checksum</p>   |                   |
|                                       | <p><i>Sync1</i></p>  | <p><i>Sync2</i></p>            | <p><i>Desc. Set</i></p> | <p><i>Payload Length</i></p> | <p><i>Field Length</i></p>   | <p><i>Field Desc.</i></p> | <p><i>Field Data</i></p>  | <p><i>MSB</i></p> | <p><i>LSB</i></p> |
| <p><i>Command</i></p>                 | <p>0x75</p>  | <p>0x65</p>                    | <p>0x0D</p>             | <p>0x15</p>                  | <p>0x15</p>  | <p>0x1F</p>               | <p>GNSS TOW: 30,000.0<br/>                 GNSS Week Number: 1700<br/>                 Angle: (0.01f)<br/>                 Angle Sigma: (0.01f)<br/>                 Heading 0x01<br/>                 Type: (True)</p> | <p>0xXX</p>       | <p>0xXX</p>       |

|   |      |      |      |      |      |      |                                    |      |      |
|---|------|------|------|------|------|------|------------------------------------|------|------|
| <i>Reply Field:<br/>ACK/NACK</i>              | 0x75 | 0x65 | 0x0D | 0x04 | 0x04 | 0xF1 | Echo Cmd: 0x01<br>Error Code: 0x00 | 0xFF | 0xEE |
| <i>Copy-Paste version of the command: N/A</i> |      |      |      |      |      |      |                                    |      |      |

#### 4.3.14 Pitch/Roll Aiding Control (0x0D, 0x4B)

|   |  |                         |                  |                       |  |                    |                                    |            |            |
|---|--|-------------------------|------------------|-----------------------|--|--------------------|------------------------------------|------------|------------|
| <b>Description</b>  | <p>Select pitch/roll aiding input. Pitch/roll reading is always derived from GNSS corrected inertial solution. Aiding inputs are used to improve that solution during periods of low dynamics and GNSS outages.</p> <p><i>Possible function selector values:</i></p> <ul style="list-style-type: none"> <li>0x01 - Use new settings</li> <li>0x02 - Read back current settings</li> <li>0x03 - Save current settings as startup settings</li> <li>0x04 - Load saved startup settings</li> <li>0x05 - Reset to factory default settings</li> </ul> <p><i>Possible altitude aiding selector values:</i></p> <ul style="list-style-type: none"> <li>0x00 - No pitch/roll aiding (disable)</li> <li>0x01 - Enable gravity vector aiding</li> </ul> |                         |                  |                       |  |                    |                                    |            |            |
| <b>Field Format</b>   | <i>Field Length</i>  | <i>Field Descriptor</i> |                  |                       | <i>Field Data</i>  |                    |                                    |            |            |
| <i>Command</i>  | 0x05   | 0x4B                    |                  |                       | U8 - Function Selector<br>U8 - Aiding (0 - Disable, 1 - Enable)              |                    |                                    |            |            |
| <i>Reply Field:<br/>ACK/NACK</i>                                      | 0x04   | 0xF1                    |                  |                       | U8 - Echo the command descriptor<br>U8 - Error code (0: ACK, non-zero: NACK) |                    |                                    |            |            |
| <i>Reply Field:<br/>Function = 2</i>                                  | 0x03   | 0xBB                    |                  |                       | U8 - Aiding Selector Value   |                    |                                    |            |            |
| <b>Example</b>  | MIP Packet Header  |                         |                  |                       | Command/Reply Fields   |                    |                                    | Checksum   |            |
|   | <i>Sync1</i>   | <i>Sync2</i>            | <i>Desc. Set</i> | <i>Payload Length</i> | <i>Field Length</i>  | <i>Field Desc.</i> | <i>Field Data</i>                  | <i>MSB</i> | <i>LSB</i> |
| <i>Command</i>  | 0x75   | 0x65                    | 0x0D             | 0x04                  | 0x04   | 0x4B               | Fctn (Apply): 0x01<br>Enable: 0x01 | 0x3C       | 0xC1       |
| <i>Reply Field:<br/>ACK/NACK</i>                                      | 0x75   | 0x65                    | 0x0D             | 0x04                  | 0x04   | 0xF1               | Echo cmd: 0x47<br>Error code: 0x00 | 0xB9       | 0xF0       |
| <i>Copy-Paste version of the command: "7565 0D04 044B 0101 3CC1 "</i> |  |                         |                  |                       |  |                    |                                    |            |            |

## 4.3.15 Altitude Aiding Control (0x0D, 0x47)

|   |   |              |                         |                       |  |                    |                                    |            |            |
|---|---|--------------|-------------------------|-----------------------|--|--------------------|------------------------------------|------------|------------|
| <b>Description</b>  | <p>Select altitude input for absolute altitude and/or vertical velocity. The primary altitude reading is always GNSS. Aiding inputs are used to improve GNSS altitude readings when GNSS is available and to backup GNSS during GNSS outages.</p> <p><i>Possible function selector values:</i></p> <ul style="list-style-type: none"> <li>0x01 - Use new settings</li> <li>0x02 - Read back current settings</li> <li>0x03 - Save current settings as startup settings</li> <li>0x04 - Load saved startup settings</li> <li>0x05 - Reset to factory default settings</li> </ul> <p><i>Possible altitude aiding selector values:</i></p> <ul style="list-style-type: none"> <li>0x00 - No altitude aiding (disable)</li> <li>0x01 - Enable pressure sensor aiding<sup>1</sup></li> </ul> |              |                         |                       |  |                    |                                    |            |            |
| <b>Notes</b>  | 1. Pressure altitude is based on "instant sea level pressure" which is dependent on location and weather conditions and can vary by more than 40 meters.  |              |                         |                       |  |                    |                                    |            |            |
| <b>Field Format</b>   | <i>Field Length</i>   |              | <i>Field Descriptor</i> |                       | <i>Field Data</i>  |                    |                                    |            |            |
| <i>Command</i>  | 0x05  |              | 0x47                    |                       | U8 - Function Selector<br>U8 - Aiding (0 - Disable, 1 - Enable)              |                    |                                    |            |            |
| <i>Reply Field:<br/>ACK/NACK</i>                                      | 0x04  |              | 0xF1                    |                       | U8 - Echo the command descriptor<br>U8 - Error code (0: ACK, non-zero: NACK) |                    |                                    |            |            |
| <i>Reply Field:<br/>Function = 2</i>                                  | 0x03  |              | 0xB7                    |                       | U8 - Aiding Selector Value   |                    |                                    |            |            |
| <b>Example</b>  | MIP Packet Header   |              |                         |                       | Command/Reply Fields   |                    |                                    | Checksum   |            |
|   | <i>Sync1</i>  | <i>Sync2</i> | <i>Desc. Set</i>        | <i>Payload Length</i> | <i>Field Length</i>  | <i>Field Desc.</i> | <i>Field Data</i>                  | <i>MSB</i> | <i>LSB</i> |
| <i>Command</i>  | 0x75  | 0x65         | 0x0D                    | 0x04                  | 0x04   | 0x47               | Fctn (Apply): 0x01<br>Enable: 0x01 | 0x38       | 0xB5       |
| <i>Reply Field:<br/>ACK/NACK</i>                                      | 0x75  | 0x65         | 0x0D                    | 0x04                  | 0x04   | 0xF1               | Echo cmd: 0x47<br>Error code: 0x00 | 0x27       | 0x3E       |
| <i>Copy-Paste version of the command: "7565 0D04 0447 0101 38B5 "</i> |   |              |                         |                       |  |                    |                                    |            |            |

## 4.3.16 Auto-Initialization Control (0x0D, 0x19)

|  |  |              |                         |                       |  |                    |   |            |            |
|--|--|--------------|-------------------------|-----------------------|--|--------------------|---|------------|------------|
| <b>Description</b>   | Enable/Disable automatic initialization upon device startup.   |              |                         |                       |  |                    |   |            |            |
|  | Possible function selector values:<br>0x01 - Use new settings<br>0x02 - Read back current settings<br>0x03 - Save current settings as startup settings<br>0x04 - Load saved startup settings<br>0x05 - Reset to factory default settings<br>Possible enable values:<br>0x00 - Disable auto-initialization<br>0x01 - Enable auto-initialization (requires valid heading source) |              |                         |                       |  |                    |   |            |            |
| <b>Notes</b>   | <ul style="list-style-type: none"> <li>Even if this option is enabled, the filter will not initialize if there is no heading source. If there is no heading source, you can initialize the filter using the <a href="#">SetInitialHeading</a> command or <a href="#">SetInitialAttitude</a> command.</li> </ul>  |              |                         |                       |  |                    |   |            |            |
| <b>Field Format</b>  | <i>Field Length</i>  |              | <i>Field Descriptor</i> |                       | <i>Field Data</i>  |                    |   |            |            |
| <i>Command</i>   | 0x04   |              | 0x19                    |                       | U8 - Function Selector<br>U8 - Enable Value                                  |                    |   |            |            |
| <i>Reply Field 1:<br/>ACK/NACK</i>                                   | 0x04   |              | 0xF1                    |                       | U8 - Echo the command descriptor<br>U8 - Error code (0: ACK, non-zero: NACK) |                    |   |            |            |
| <i>Reply Field 2:<br/>Function = 2</i>                               | 0x03   |              | 0x88                    |                       | U8 - Enable Value  |                    |   |            |            |
| <b>Example</b>   | MIP Packet Header  |              |                         |                       | Command/Reply Fields   |                    |   | Checksum   |            |
|  | <i>Sync1</i>   | <i>Sync2</i> | <i>Desc. Set</i>        | <i>Payload Length</i> | <i>Field Length</i>  | <i>Field Desc.</i> | <i>Field Data</i>                                 | <i>MSB</i> | <i>LSB</i> |
| <i>Command:</i>  | 0x75   | 0x65         | 0x0D                    | 0x04                  | 0x04   | 0x19               | Fctn (Apply): 0x01<br>Enable: auto-initialization | 0x0A       | 0x2B       |
| <i>Reply Field 1:<br/>ACK/NACK</i>                                   | 0x75   | 0x65         | 0x0D                    | 0x04                  | 0x04   | 0xF1               | Echo cmd: 0x19<br>Error code: 0x00                | 0xF9       | 0xE2       |
| <i>Copy-Paste version of the command: "7565 0D04 0419 0101 0A2B"</i> |  |              |                         |                       |  |                    |   |            |            |

## 4.3.17 Magnetometer Noise Standard Deviation (0x0D, 0x42)

|   |   |              |                         |                       |   |                    |  |            |            |
|---|---|--------------|-------------------------|-----------------------|---|--------------------|--|------------|------------|
| <b>Description</b>                            | Set the expected magnetometer noise 1-sigma values.   |              |                         |                       |   |                    |  |            |            |
|   | This function can be used to tune the filter performance in the target application.   |              |                         |                       |   |                    |  |            |            |
| <b>Description</b>                            | Possible function selector values:  |              |                         |                       |   |                    |  |            |            |
|   | <ul style="list-style-type: none"> <li>0x01 - Use new settings</li> <li>0x02 - Read back current settings</li> <li>0x03 - Save current settings as startup settings</li> <li>0x04 - Load saved startup settings</li> <li>0x05 - Reset to factory default settings</li> </ul>        |              |                         |                       |   |                    |  |            |            |
| <b>Description</b>                            | Each of the noise values must be greater than 0.0   |              |                         |                       |   |                    |  |            |            |
|   | The noise value represents process noise in the 3DM-GX5 NAV Estimation Filter. Changing this value modifies how the filter responds to dynamic input and can be used to tune the performance of the filter. Default values provide good performance for most laboratory conditions. |              |                         |                       |   |                    |  |            |            |
| <b>Field Format</b>                           | <i>Field Length</i>   |              | <i>Field Descriptor</i> |                       | <i>Field Data</i>   |                    |  |            |            |
| <i>Command</i>                                | 0x0F  |              | 0x42                    |                       | U8 - Function Selector<br>Float - X Mag Noise 1-sigma (gauss)<br>Float - Y Mag Noise 1-sigma (gauss)<br>Float - Z Mag Noise 1-sigma (gauss) |                    |  |            |            |
| <i>Reply Field 1:<br/>ACK/NACK</i>            | 0x04  |              | 0xF1                    |                       | U8 - Echo the command descriptor<br>U8 - Error code (0: ACK, non-zero: NACK)  |                    |  |            |            |
| <i>Reply Field 2:<br/>Function = 2</i>        | 0x0E  |              | 0xB1                    |                       | Float - X Mag Noise 1-sigma (gauss)<br>Float - Y Mag Noise 1-sigma (gauss)<br>Float - Z Mag Noise 1-sigma (gauss)                           |                    |  |            |            |
| <b>Example</b>                                | MIP Packet Header   |              |                         |                       | Command/Reply Fields  |                    |  | Checksum   |            |
|   | <i>Sync1</i>  | <i>Sync2</i> | <i>Desc. Set</i>        | <i>Payload Length</i> | <i>Field Length</i>   | <i>Field Desc.</i> | <i>Field Data</i>  | <i>MSB</i> | <i>LSB</i> |
| <i>Command</i>                                | 0x75  | 0x65         | 0x0D                    | 0x0F                  | 0x0F  | 0x42               | Fctn (Apply): 0x01<br>X: (0.02f)<br>Y: (0.02f)<br>Z: (0.02f) | 0x         | 0x         |
| <i>Reply Field 1:<br/>ACK/NACK</i>            | 0x75  | 0x65         | 0x0D                    | 0x04                  | 0x04  | 0xF1               | Echo cmd: 0x42<br>Error code: 0x00                           | 0x22       | 0x34       |
| <i>Copy-Paste version of the command: N/A</i> |   |              |                         |                       |   |                    |  |            |            |

## 4.3.18 Gravity Noise Standard Deviation (0x0D, 0x28)

|  |   |                         |                  |                       |   |                    |  |            |            |
|--|---|-------------------------|------------------|-----------------------|---|--------------------|--|------------|------------|
| <b>Description</b>                     | Set the expected gravity noise 1-sigma values. This function can be used to tune the filter performance in the target application.  |                         |                  |                       |   |                    |  |            |            |
|  | Each of the noise values must be greater than 0.0   |                         |                  |                       |   |                    |  |            |            |
| <b>Description</b>                     | The noise value represents process noise in the EKF. Changing this value modifies how the filter responds to dynamic input and can be used to tune the performance of the filter. Default values provide good performance for most laboratory conditions. |                         |                  |                       |   |                    |  |            |            |
|  | Possible function selector values:  |                         |                  |                       |   |                    |  |            |            |
|  | 0x01 - Use new settings   |                         |                  |                       |   |                    |  |            |            |
|  | 0x02 - Read back current settings   |                         |                  |                       |   |                    |  |            |            |
|  | 0x03 - Save current settings as startup settings  |                         |                  |                       |   |                    |  |            |            |
|  | 0x04 - Load saved startup settings  |                         |                  |                       |   |                    |  |            |            |
|  | 0x05 - Reset to factory default settings  |                         |                  |                       |   |                    |  |            |            |
| <b>Field Format</b>                    | <i>Field Length</i>   | <i>Field Descriptor</i> |                  |                       | <i>Field Data</i>   |                    |  |            |            |
| <i>Command</i>                         | 0x05  | 0x28                    |                  |                       | U8 - Function Selector<br>Float - X Gravity Noise 1-sigma (g)<br>Float - Y Gravity Noise 1-sigma (g)<br>Float - Z Gravity Noise 1-sigma (g) |                    |  |            |            |
| <i>Reply Field 1:<br/>ACK/NACK</i>     | 0x04  | 0xF1                    |                  |                       | U8 - Echo the command descriptor<br>U8 - Error code (0: ACK, non-zero: NACK)  |                    |  |            |            |
| <i>Reply Field 2:<br/>Function = 2</i> | 0x0E  | 0x93                    |                  |                       | Float - X Gravity Noise 1-sigma (g)<br>Float - Y Gravity Noise 1-sigma (g)<br>Float - Z Gravity Noise 1-sigma (g)                           |                    |  |            |            |
| <b>Example</b>                         | MIP Packet Header   |                         |                  |                       | Command/Reply Fields  |                    |  | Checksum   |            |
|  | <i>Sync1</i>  | <i>Sync2</i>            | <i>Desc. Set</i> | <i>Payload Length</i> | <i>Field Length</i>   | <i>Field Desc.</i> | <i>Field Data</i>  | <i>MSB</i> | <i>LSB</i> |
| <i>Command</i>                         | 0x75  | 0x65                    | 0x0D             | 0x05                  | 0x05  |                    | <i>Fctn (Apply): 0x01</i><br><i>X: (0.01f)</i><br><i>Y: (0.01f)</i><br><i>Z: (0.01f)</i> | 0x         | 0x         |
| <i>Reply Field 1:<br/>ACK/NACK</i>     | 0x75  | 0x65                    | 0x0D             | 0x04                  | 0x04  | 0xF1               | <i>Echo cmd: 0x28</i><br><i>Error code: 0x00</i>   | 0x         | 0x         |

## 4.3.19 Pressure Altitude Noise Standard Deviation (0x0D, 0x29)

|  |  |              |                         |                       |  |                    |   |                 |            |
|--|--|--------------|-------------------------|-----------------------|--|--------------------|---|-----------------|------------|
| <b>Description</b>                     | Set the expected pressure altitude noise 1-sigma values. This function can be used to tune the filter performance in the target application.   |              |                         |                       |  |                    |   |                 |            |
|  | Each of the noise values must be greater than 0.0  |              |                         |                       |  |                    |   |                 |            |
| <b>Description</b>                     | The noise value represents pressure altitude model noise in the EKF. A lower value will increase responsiveness of the sensor to pressure changes, however height estimates will be more susceptible to error from air pressure fluctuations not due to changes in altitude. Default values provide good performance for most laboratory conditions. |              |                         |                       |  |                    |   |                 |            |
|  | Possible function selector values:   |              |                         |                       |  |                    |   |                 |            |
|  | 0x01 - Use new settings  |              |                         |                       |  |                    |   |                 |            |
|  | 0x02 - Read back current settings  |              |                         |                       |  |                    |   |                 |            |
|  | 0x03 - Save current settings as startup settings   |              |                         |                       |  |                    |   |                 |            |
|  | 0x04 - Load saved startup settings   |              |                         |                       |  |                    |   |                 |            |
|  | 0x05 - Reset to factory default settings   |              |                         |                       |  |                    |   |                 |            |
| <b>Field Format</b>                    | <i>Field Length</i>  |              | <i>Field Descriptor</i> |                       | <i>Field Data</i>  |                    |   |                 |            |
| <i>Command</i>                         | 0x05   |              | 0x29                    |                       | U8 - Function Selector<br>Float - Pressure Altitude Noise 1-sigma (m)        |                    |   |                 |            |
| <i>Reply Field 1:<br/>ACK/NACK</i>     | 0x04   |              | 0xF1                    |                       | U8 - Echo the command descriptor<br>U8 - Error code (0: ACK, non-zero: NACK) |                    |   |                 |            |
| <i>Reply Field 2:<br/>Function = 2</i> | 0x04   |              | 0x94                    |                       | Float - Pressure Altitude Noise 1-sigma (m)                                  |                    |   |                 |            |
| <b>Example</b>                         | <b>MIP Packet Header</b>   |              |                         |                       | <b>Command/Reply Fields</b>  |                    |   | <b>Checksum</b> |            |
|  | <i>Sync1</i>   | <i>Sync2</i> | <i>Desc. Set</i>        | <i>Payload Length</i> | <i>Field Length</i>  | <i>Field Desc.</i> | <i>Field Data</i>   | <i>MSB</i>      | <i>LSB</i> |
| <i>Command</i>                         | 0x75   | 0x65         | 0x0D                    | 0x05                  | 0x05   | 0x29               | <i>Fctr (Apply): 0x01<br/>Press. Altitude<br/>Noise: (1.0f)</i> | 0xDE            | 0x4E       |
| <i>Reply Field 1:<br/>ACK/NACK</i>     | 0x75   | 0x65         | 0x0D                    | 0x04                  | 0x04   | 0xF1               | <i>Echo cmd: 0x29<br/>Error code: 0x00</i>                      | 0x97            | 0xAC       |

## 4.3.20 Accelerometer Noise Standard Deviation (0x0D, 0x1A)

|                    |  |
|--------------------|--|
| <b>Description</b> | Set the expected accelerometer noise 1-sigma values. This function can be used to tune |
|--------------------|--|



## 4.3.20 Accelerometer Noise Standard Deviation (0x0D, 0x1A)

the filter performance in the target application.

Possible function selector values:

- 0x01 - Use new settings
- 0x02 - Read back current settings
- 0x03 - Save current settings as startup settings
- 0x04 - Load saved startup settings
- 0x05 - Reset to factory default settings

Each of the noise values must be greater than 0.0

The noise value represents process noise in the 3DM-GX5-45 NAV Estimation Filter. Changing this value modifies how the filter responds to dynamic input and can be used to tune the performance of the filter. Default values provide good performance for most laboratory conditions.

| Field Format  | Field Length      | Field Descriptor | Field Data   |                       |                      |                    |  |            |            |
|---|-------------------|------------------|--|-----------------------|----------------------|--------------------|--|------------|------------|
| <i>Command</i>  | 0x0F              | 0x1A             | U8 - Function Selector<br>Float - X Accel Noise 1-sigma(meters/second <sup>2</sup> )<br>Float - Y Accel Noise 1-sigma(meters/second <sup>2</sup> )<br>Float - Z Accel Noise 1-sigma (meters/second <sup>2</sup> )<br>U8 - echo the command descriptor<br>U8 - error code (0:ACK, not 0:NACK) |                       |                      |                    |  |            |            |
| <i>Reply Field 1:<br/>ACK/NACK</i>  | 0x04              | 0xF1             | U8 - Echo the command descriptor<br>U8 - Error code (0:ACK, non-zero: NACK)  |                       |                      |                    |  |            |            |
| <i>Reply Field 2:<br/>Function = 2</i>  | 0x0E              | 0x89             | Float - X Accel Noise 1-sigma(meters/second <sup>2</sup> )<br>Float - Y Accel Noise 1-sigma(meters/second <sup>2</sup> )<br>Float - Z Accel Noise 1-sigma (meters/second <sup>2</sup> )  |                       |                      |                    |  |            |            |
| Example   | MIP Packet Header |                  |  |                       | Command/Reply Fields |                    |  | Checksum   |            |
|   | <i>Sync1</i>      | <i>Sync2</i>     | <i>Desc. Set</i>   | <i>Payload Length</i> | <i>Field Length</i>  | <i>Field Desc.</i> | <i>Field Data</i>  | <i>MSB</i> | <i>LSB</i> |
| <i>Command</i>  | 0x75              | 0x65             | 0x0D   | 0x0F                  | 0x0F                 | 0x1A               | Fctn (Apply): 0x01<br>X: (0.02f)<br>Y: (0.02f)<br>Z: (0.02f) | 0x60       | 0xA3       |
| <i>Reply Field 1:<br/>ACK/NACK</i>  | 0x75              | 0x65             | 0x0D   | 0x04                  | 0x04                 | 0xF1               | Echo cmd: 0x1A<br>Error code: 0x00                           | 0xFA       | 0xE4       |
| <i>Copy-Paste version of the command: "7565 0D0F 0F01 1A013CA3D70A3CA3D70A3CA3D760A3"</i> |                   |                  |  |                       |                      |                    |  |            |            |

## 4.3.21 Accelerometer Bias Model Parameters (0x0D, 0x1C)

|  |   |              |                         |                       |  |                    |   |                 |            |
|--|---|--------------|-------------------------|-----------------------|--|--------------------|---|-----------------|------------|
| <b>Description</b>                     | Set the accelerometer bias model parameters.  |              |                         |                       |  |                    |   |                 |            |
|  | Possible function selector values:<br>0x01 - Use new settings<br>0x02 - Read back current settings<br>0x03 - Save current settings as startup settings<br>0x04 - Load saved startup settings<br>0x05 - Reset to factory default settings<br>Each of the noise values must be greater than 0.0 |              |                         |                       |  |                    |   |                 |            |
| <b>Field Format</b>                    | <i>Field Length</i>   |              | <i>Field Descriptor</i> |                       | <i>Field Data</i>  |                    |   |                 |            |
| <i>Command</i>                         | 0x1B  |              | 0x1C                    |                       | U8 - Function Selector<br>Float - X Accel Bias Beta (1/second)<br>Float - Y Accel Bias Beta (1/second)<br>Float - Z Accel Bias Beta (1/second)<br>Float - X Accel Bias Noise 1-sigma (m/s <sup>2</sup> )<br>Float - Y Accel Bias Noise 1-sigma (m/s <sup>2</sup> )<br>Float - Z Accel Bias Noise 1-sigma (m/s <sup>2</sup> ) |                    |   |                 |            |
| <i>Reply Field 1:<br/>ACK/NACK</i>     | 0x04  |              | 0xF1                    |                       | U8 - Echo the command descriptor<br>U8 - Error code (0: ACK, non-zero: NACK)   |                    |   |                 |            |
| <i>Reply Field 2:<br/>Function = 2</i> | 0x1A  |              | 0x8B                    |                       | Float - X Accel Bias Beta (1/second)<br>Float - Y Accel Bias Beta (1/second)<br>Float - Z Accel Bias Beta (1/second)<br>Float - X Accel Bias Noise 1-sigma (m/s <sup>2</sup> )<br>Float - Y Accel Bias Noise 1-sigma (m/s <sup>2</sup> )<br>Float - Z Accel Bias Noise 1-sigma (m/s <sup>2</sup> )                           |                    |   |                 |            |
| <b>Example</b>                         | <b>MIP Packet Header</b>  |              |                         |                       | <b>Command/Reply Fields</b>  |                    |   | <b>Checksum</b> |            |
|  | <i>Sync1</i>  | <i>Sync2</i> | <i>Desc. Set</i>        | <i>Payload Length</i> | <i>Field Length</i>  | <i>Field Desc.</i> | <i>Field Data</i>   | <i>MSB</i>      | <i>LSB</i> |
| <i>Command</i>                         | 0x75  | 0x65         | 0x0D                    | 0x0F                  | 0x1B   | 0x1C               | Fctn (Apply): 0x01<br>X Beta: (0.01f)<br>Y Beta: (0.01f)<br>Z Beta: (0.01f)<br>X Noise: (0.0006f)<br>Y Noise: (0.0006f)<br>Z Noise: (0.0006f) | 0xXX            | 0xXX       |
| <i>Reply Field 1:<br/>ACK/NACK</i>     | 0x75  | 0x65         | 0x0D                    | 0x04                  | 0x04   | 0xF1               | Echo cmd: 0x1C<br>Error code: 0x00  | 0xFC            | 0xE8       |

Copy-Paste version of the command: N/A

### 4.3.22 Gyroscope Noise Standard Deviation (0x0D, 0x1B)

|  |  |                     |                         |                       |   |                    |  |                 |            |
|--|--|---------------------|-------------------------|-----------------------|---|--------------------|--|-----------------|------------|
| <b>Description</b>                     | <p>Set the expected gyroscope noise 1-sigma values.<br/>This function can be used to tune the filter performance in the target application.</p> <p>Possible function selector values:</p> <ul style="list-style-type: none"> <li>0x01 - Use new settings</li> <li>0x02 - Read back current settings</li> <li>0x03 - Save current settings as startup settings</li> <li>0x04 - Load saved startup settings</li> <li>0x05 - Reset to factory default settings</li> </ul> <p>Each of the noise values must be greater than 0.0</p> <p>The noise value represents process noise in the 3DM-GX5 NAV Estimation Filter. Changing this value modifies how the filter responds to dynamic input and can be used to tune the performance of the filter. Default values provide good performance for most laboratory conditions.</p> |                     |                         |                       |   |                    |  |                 |            |
|  | <b>Field Format</b>  | <i>Field Length</i> | <i>Field Descriptor</i> |                       |   | <i>Field Data</i>  |  |                 |            |
| <i>Command</i>                         | 0x0F   | 0x1B                |                         |                       | U8 - Function Selector<br>Float - X Gyro Noise 1-sigma (rad/second)<br>Float - Y Gyro Noise 1-sigma (rad/second)<br>Float - Z Gyro Noise 1-sigma (rad/second) |                    |  |                 |            |
| <i>Reply Field 1:<br/>ACK/ NACK</i>    | 0x04   | 0xF1                |                         |                       | U8 - Echo the command descriptor<br>U8 - Error code (0: ACK, non-zero: NACK)  |                    |  |                 |            |
| <i>Reply Field 2:<br/>Function = 2</i> | 0x0E   | 0x8A                |                         |                       | Float - X Gyro Noise 1-sigma (rad/second)<br>Float - Y Gyro Noise 1-sigma (rad/second)<br>Float - Z Gyro Noise 1-sigma (rad/second)                           |                    |  |                 |            |
| <b>Example</b>                         | <b>MIP Packet Header</b>   |                     |                         |                       | <b>Command/Reply Fields</b>   |                    |  | <b>Checksum</b> |            |
|  | <i>Sync1</i>   | <i>Sync2</i>        | <i>Desc. Set</i>        | <i>Payload Length</i> | <i>Field Length</i>   | <i>Field Desc.</i> | <i>Field Data</i>  | <i>MSB</i>      | <i>LSB</i> |
| <i>Command</i>                         | 0x75   | 0x65                | 0x0D                    | 0x0F                  | 0x0F  | 0x1B               | Fctn 0x01<br>(Apply):<br>X: (0.0000539f)<br>Y: (0.0000539f)<br>Z: (0.0000539f) | 0xDE            | 0xE8       |

|  |             |             |             |             |             |             |  |             |             |
|--|-------------|-------------|-------------|-------------|-------------|-------------|--|-------------|-------------|
| <i>Reply Field 1:<br/>ACK/NACK</i>   | <b>0x75</b> | <b>0x65</b> | <b>0x0D</b> | <b>0x04</b> | <b>0x04</b> | <b>0xF1</b> | Echo cmd: <b>0x1B</b><br>Error code: <b>0x00</b> | <b>0xFB</b> | <b>0xE6</b> |
| <i>Copy-Paste version of the command: "7565 0D0F 0F1B 013A 0D4B AD3A 0D4B AD3A 0D4B ADDE E8"</i> |             |             |             |             |             |             |  |             |             |

## 4.3.23 Gyroscope Bias Model Parameters (0x0D, 0x1D)

|   |   |              |                         |                       |  |                    |  |                 |            |
|---|---|--------------|-------------------------|-----------------------|--|--------------------|--|-----------------|------------|
| <b>Description</b>                            | Set the gyroscope bias model parameters.  |              |                         |                       |  |                    |  |                 |            |
|   | Possible function selector values:<br><br>0x01 - Use new settings<br>0x02 - Read back current settings<br>0x03 - Save current settings as startup settings<br>0x04 - Load saved startup settings<br>0x05 - Reset to factory default settings<br><br>Each of the noise values must be greater than 0.0 |              |                         |                       |  |                    |  |                 |            |
| <b>Field Format</b>                           | <i>Field Length</i>   |              | <i>Field Descriptor</i> |                       | <i>Field Data</i>  |                    |  |                 |            |
| <i>Command</i>                                | 0x1B  |              | 0x1D                    |                       | U8 - Function Selector<br>Float - X Gyro Bias Beta (1/second)<br>Float - Y Gyro Bias Beta (1/second)<br>Float - Z Gyro Bias Beta (1/second)<br>Float - X Gyro Bias Noise 1-sigma (rad /second)<br>Float - Y Gyro Bias Noise 1-sigma (rad /second)<br>Float - Z Gyro Bias Noise 1-sigma (rad /second) |                    |  |                 |            |
| <i>Reply Field 1:<br/>ACK/NACK</i>            | 0x04  |              | 0xF1                    |                       | U8 - Echo the command descriptor<br>U8 - Error code (0: ACK, non-zero: NACK)   |                    |  |                 |            |
| <i>Reply Field 2:<br/>Function = 2</i>        | 0x1A  |              | 0x8C                    |                       | Float - X Gyro Bias Beta (1/second)<br>Float - Y Gyro Bias Beta (1/second)<br>Float - Z Gyro Bias Beta (1/second)<br>Float - X Gyro Bias Noise 1-sigma (rad /second)<br>Float - Y Gyro Bias Noise 1-sigma (rad /second)<br>Float - Z Gyro Bias Noise 1-sigma (rad /second)                           |                    |  |                 |            |
| <b>Example</b>                                | <b>MIP Packet Header</b>  |              |                         |                       | <b>Command/Reply Fields</b>  |                    |  | <b>Checksum</b> |            |
|   | <i>Sync1</i>  | <i>Sync2</i> | <i>Desc. Set</i>        | <i>Payload Length</i> | <i>Field Length</i>  | <i>Field Desc.</i> | <i>Field Data</i>  | <i>MSB</i>      | <i>LSB</i> |
| <i>Command</i>                                | 0x75  | 0x65         | 0x0D                    | 0x0F                  | 0x1B   | 0x1D               | Fctn (Apply): 0x01<br>X Beta: (0.01f)<br>Y Beta: (0.01f)<br>Z Beta: (0.01f)<br>X Noise: (0.00016f)<br>Y Noise: (0.00016f)<br>Z Noise: (0.00016f) | 0xXX            | 0xXX       |
| <i>Reply Field 1:<br/>ACK/NACK</i>            | 0x75  | 0x65         | 0x0D                    | 0x04                  | 0x04   | 0xF1               | Echo cmd: 0x1D<br>Error code: 0x00   | 0xFD            | 0xEA       |
| <i>Copy-Paste version of the command: N/A</i> |   |              |                         |                       |  |                    |  |                 |            |

## 4.3.24 Hard Iron Offset Process Noise (0x0D, 0x2B)

|  |  |                     |   |                       |                             |                    |   |                 |            |
|--|--|---------------------|---|-----------------------|-----------------------------|--------------------|---|-----------------|------------|
| <b>Description</b>   | <p>Set the expected hard iron offset noise 1-sigma values.</p> <p>This function can be used to tune the filter performance in the target application.</p> <p>Possible function selector values:</p> <ul style="list-style-type: none"> <li>0x01 - Use new settings</li> <li>0x02 - Read back current settings.</li> <li>0x03 - Save current settings as startup settings</li> <li>0x04 - Load saved startup settings</li> <li>0x05 - Reset to factory default settings</li> </ul> <p>Each of the noise values must be greater than 0.0</p> <p>The noise value represents process noise in the 3DM-GX5-45 NAV Estimation Filter. Changing this value modifies how the filter responds to dynamic input and can be used to tune the performance of the filter. Default values provide good performance for most laboratory conditions.</p> |                     |   |                       |                             |                    |   |                 |            |
|  | <b>Field Format</b>  | <i>Field Length</i> | <i>Field Descriptor</i>   | <i>Field Data</i>     |                             |                    |   |                 |            |
| <i>Command</i>   | 0x0F   | 0x2B                | U8 - Function Selector<br>Float - X HI Offset Noise 1-sigma (gauss)<br>Float - Y HI Offset Noise 1-sigma (gauss)<br>Float - Z HI Offset Noise 1-sigma (gauss) |                       |                             |                    |   |                 |            |
| <i>Reply Field 1:<br/>ACK/NACK</i>   | 0x04   | 0xF1                | U8 - Echo the command descriptor<br>U8 - Error code (0: ACK, non-zero: NACK)  |                       |                             |                    |   |                 |            |
| <i>Reply Field 2:<br/>Function = 2</i>   | 0x0E   | 0x96                | Float - X HI Offset Noise 1-sigma (gauss)<br>Float - Y HI Offset Noise 1-sigma (gauss)<br>Float - Z HI Offset Noise 1-sigma (gauss)                           |                       |                             |                    |   |                 |            |
| <b>Example</b>   | <b>MIP Packet Header</b>   |                     |   |                       | <b>Command/Reply Fields</b> |                    |   | <b>Checksum</b> |            |
|  | <i>Sync1</i>   | <i>Sync2</i>        | <i>Desc. Set</i>  | <i>Payload Length</i> | <i>Field Length</i>         | <i>Field Desc.</i> | <i>Field Data</i>   | <i>MSB</i>      | <i>LSB</i> |
| <i>Command</i>   | 0x75   | 0x65                | 0x0D  | 0x0F                  | 0x0F                        | 0x2B               | <i>Fctn (Apply): 0x01</i><br><i>X: (0.001f)</i><br><i>Y: (0.001f)</i><br><i>Z: (0.001f)</i> | 0xEB            | 0xD2       |
| <i>Reply Field 1:<br/>ACK/NACK</i>   | 0x75   | 0x65                | 0x0D  | 0x04                  | 0x04                        | 0xF1               | <i>Echo cmd: 0x2B</i><br><i>Error code: 0x00</i>  | 0x0B            | 0x06       |
| <i>Copy-Paste version of the command: ""7565 0D0F 0F2B 013A 8312 6F3A 8312 6F3A 8312 6FEB D2</i> |  |                     |   |                       |                             |                    |   |                 |            |

## 4.3.25 Soft Iron Matrix Process Noise (0x0D, 0x2C)

|   |   |              |                         |                       |  |                    |   |            |            |
|---|---|--------------|-------------------------|-----------------------|--|--------------------|---|------------|------------|
| <b>Description</b>  | Set the expected hard iron offset noise 1-sigma values.<br>This function can be used to tune the filter performance in the target application.  |              |                         |                       |  |                    |   |            |            |
|   | Possible function selector values:<br><br>0x01 - Use new settings<br>0x02 - Read back current settings.<br>0x03 - Save current settings as startup settings 0x04 -<br>Load saved startup settings<br>0x05 - Reset to factory default settings<br><br>Each of the noise values must be greater than 0.0 (gauss).<br><br>The noise value represents process noise in the 3DM-GX5-45 NAV Estimation Filter. Changing this value modifies how the filter responds to dynamic input and can be used to tune the performance of the filter. Default values provide good performance for most laboratory conditions. |              |                         |                       |  |                    |   |            |            |
| <b>Field Format</b>   | <i>Field Length</i>   |              | <i>Field Descriptor</i> |                       | <i>Field Data</i>  |                    |   |            |            |
| <i>Command</i>  | 0x0F  |              | 0x2C                    |                       | U8 - Function Selector<br>Float - m <sub>1,1</sub> Float - m <sub>1,2</sub> Float - m <sub>1,3</sub><br>Float - m <sub>2,1</sub> Float - m <sub>2,2</sub> Float - m <sub>2,3</sub><br>Float - m <sub>3,1</sub> Float - m <sub>3,2</sub> Float - m <sub>3,3</sub> |                    |   |            |            |
| <i>Reply Field 1:<br/>ACK/NACK</i>  | 0x04  |              | 0xF1                    |                       | U8 - Echo the command descriptor<br>U8 - Error code (0: ACK, non-zero: NACK)   |                    |   |            |            |
| <i>Reply Field 2:<br/>Function = 2</i>  | 0x26  |              | 0x97                    |                       | Float - m <sub>1,1</sub> Float - m <sub>1,2</sub> Float - m <sub>1,3</sub><br>Float - m <sub>2,1</sub> Float - m <sub>2,2</sub> Float - m <sub>2,3</sub><br>Float - m <sub>3,1</sub> Float - m <sub>3,2</sub> Float - m <sub>3,3</sub>                           |                    |   |            |            |
| <b>Example</b>  | MIP Packet Header   |              |                         |                       | Command/Reply Fields   |                    |   | Checksum   |            |
|   | <i>Sync1</i>  | <i>Sync2</i> | <i>Desc. Set</i>        | <i>Payload Length</i> | <i>Field Length</i>  | <i>Field Desc.</i> | <i>Field Data</i>   | <i>MSB</i> | <i>LSB</i> |
| <i>Command</i>  | 0x75  | 0x65         | 0x0D                    | 0x0F                  | 0x0F   | 0x2C               | <i>Fctn (Apply):</i> 0x01<br>X: (0.0001f)<br>Y: (0.0001f)<br>Z: (0.0001f) | 0xF1       | 0x8C       |
| <i>Reply Field 1:<br/>ACK/NACK</i>  | 0x75  | 0x65         | 0x0D                    | 0x04                  | 0x04   | 0xF1               | <i>Echo cmd:</i> 0x2C<br><i>Error code:</i> 0x00                          | 0x9A       | 0xB2       |
| <i>Copy-Paste version of the command: 7565 0D27 272C 0138 D1B7 1738 D1B7 1738 D1B7 1738 D1B7 1738</i> |   |              |                         |                       |  |                    |   |            |            |
| <i>D1B7 1738 D1B7 1738 D1B7 1738 D1B7 1738 D1B7 17F1 8C</i>   |   |              |                         |                       |  |                    |   |            |            |

## 4.3.26 Zero Velocity Update (ZUPT) Control (0x0D, 0x1E)

|   |   |              |                         |                       |  |                    |   |            |            |
|---|---|--------------|-------------------------|-----------------------|--|--------------------|---|------------|------------|
| <b>Description</b>  | Control the use of zero velocity updates.   |              |                         |                       |  |                    |   |            |            |
|   | Possible function selector values:<br>0x01 - Use new settings<br>0x02 - Read back current settings<br>0x03 - Save current settings as startup settings<br>0x04 - Load saved startup settings<br>0x05 - Reset to factory default settings<br><br>The ZUPT is triggered when the scalar magnitude of the GNSS reported velocity vector is equal-to or less than the threshold value. The device will NACK threshold values that are less than zero (i.e. negative.) |              |                         |                       |  |                    |   |            |            |
| <b>Field Format</b>   | <i>Field Length</i>   |              | <i>Field Descriptor</i> |                       | <i>Field Data</i>  |                    |   |            |            |
| <i>Command</i>  | 0x08  |              | 0x1E                    |                       | U8 - Function Selector<br>U8 - Enable Value<br>Float - ZUPT threshold (m/s)  |                    |   |            |            |
| <i>Reply Field 1:<br/>ACK/NACK</i>  | 0x04  |              | 0xF1                    |                       | U8 - Echo the command descriptor<br>U8 - Error code (0: ACK, non-zero: NACK) |                    |   |            |            |
| <i>Reply Field 2:<br/>Function = 2</i>  | 0x07  |              | 0x8D                    |                       | U8 - Enable Value<br>Float - ZUPT threshold (m/s)                            |                    |   |            |            |
| <b>Example</b>  | MIP Packet Header   |              |                         |                       | Command/Reply Fields   |                    |   | Checksum   |            |
|   | <i>Sync1</i>  | <i>Sync2</i> | <i>Desc. Set</i>        | <i>Payload Length</i> | <i>Field Length</i>  | <i>Field Desc.</i> | <i>Field Data</i>   | <i>MSB</i> | <i>LSB</i> |
| <i>Command</i>  | 0x75  | 0x65         | 0x0D                    | 0x08                  | 0x08   | 0x1E               | Fctn (Apply): 0x01<br>Enable: (Enable ZUPTs) 0x01<br>Threshold: (0.01f) | 0x17       | 0xBA       |
| <i>Reply Field 1:<br/>ACK/NACK</i>  | 0x75  | 0x65         | 0x0D                    | 0x04                  | 0x04   | 0xF1               | Echo cmd: 0x1E<br>Error code: 0x00                                      | 0xFE       | 0xEC       |
| <i>Copy-Paste version of the command: "7565 0D08 081E 0101 00000000 17BA"</i> |   |              |                         |                       |  |                    |   |            |            |



## 4.3.27 Zero Angular Rate Update Control (0x0D, 0x20)

|   |   |              |                         |                       |   |                    |   |            |            |
|---|---|--------------|-------------------------|-----------------------|---|--------------------|---|------------|------------|
| <b>Description</b>  | Control the use of zero angular rate updates.   |              |                         |                       |   |                    |   |            |            |
|   | Possible function selector values:<br>0x01 - Use new settings<br>0x02 - Read back current settings<br>0x03 - Save current settings as startup settings<br>0x04 - Load saved startup settings<br>0x05 - Reset to factory default settings<br><br>The zero angular rate update is triggered when the scalar magnitude of the angular rate vector is equal-to or less than the threshold value. The device will NACK threshold values that are less than zero (i.e. negative.) |              |                         |                       |   |                    |   |            |            |
| <b>Field Format</b>   | <i>Field Length</i>   |              | <i>Field Descriptor</i> |                       | <i>Field Data</i>   |                    |   |            |            |
| <i>Command</i>  | 0x08  |              | 0x20                    |                       | U8 - Function Selector<br>U8 - Enable Value (0 - disable, 1 - enable)<br>Float -Threshold (rad/s) |                    |   |            |            |
| <i>Reply Field 1:<br/>ACK/NACK</i>  | 0x04  |              | 0xF1                    |                       | U8 - Echo the command descriptor<br>U8 - Error code (0: ACK, non-zero: NACK)                      |                    |   |            |            |
| <i>Reply Field 2:<br/>Function = 2</i>  | 0x07  |              | 0x8E                    |                       | U8 - Enable Value<br>Float - ZUPT threshold (rad/s)   |                    |   |            |            |
| <b>Example</b>  | MIP Packet Header   |              |                         |                       | Command/Reply Fields  |                    |   | Checksum   |            |
|   | <i>Sync1</i>  | <i>Sync2</i> | <i>Desc. Set</i>        | <i>Payload Length</i> | <i>Field Length</i>   | <i>Field Desc.</i> | <i>Field Data</i>   | <i>MSB</i> | <i>LSB</i> |
| <i>Command</i>  | 0x75  | 0x65         | 0x0D                    | 0x08                  | 0x08  | 0x20               | Fctn (Apply): 0x01<br>Enable: 0x01 (Enable)<br>Threshold: 0x00000000 (0.0f) | 0x19       | 0xC8       |
| <i>Reply Field 1:<br/>ACK/NACK</i>  | 0x75  | 0x65         | 0x0D                    | 0x04                  | 0x04  | 0xF1               | Echo cmd: 0x20<br>Error code: 0x00  | 0x00       | 0xF0       |
| <i>Copy-Paste version of the command: "7565 0D08 0820 0101 00000000 19C8"</i> |   |              |                         |                       |   |                    |   |            |            |

## 4.3.28 Tare Orientation (0x0D, 0x21)

|                                   |   |   |                         |                       |  |                    |                    |            |            |
|-----------------------------------|---|---|-------------------------|-----------------------|--|--------------------|--------------------|------------|------------|
| <b>Description</b>                | <p>This function uses the current device orientation relative to the NED frame as the current sensor to vehicle transformation.</p> <p>This command is provided as a convenient way to set the sensor to vehicle frame transformation.</p> <p>Possible function selector values:</p> <ul style="list-style-type: none"> <li>0x01 - Use new settings</li> <li>0x03 - Save current settings as startup settings</li> <li>0x04 - Load saved startup settings</li> <li>0x05 - Reset to factory default settings</li> </ul> <p>Possible axis bitfield values:</p> <ul style="list-style-type: none"> <li>0x00 - Reset all axis</li> <li>0x01 - Tare the roll axis</li> <li>0x02 - Tare the pitch axis</li> <li>0x04 - Tare the yaw axis</li> </ul> <p>Example Combinations:</p> <ul style="list-style-type: none"> <li>0x03 - Tare the roll and pitch axis</li> <li>0x07 - Tare all 3 axis</li> </ul> <p>Note: The filter must be initialized and have a valid attitude output. If the attitude is not valid, an error will be returned.</p> |   |                         |                       |  |                    |                    |            |            |
|                                   | <b>Notes</b>  | The filter must be initialized and have a valid attitude output. If the attitude is not valid, an error will be returned. |                         |                       |  |                    |                    |            |            |
| <b>Field Format</b>               | <i>Field Length</i>   |   | <i>Field Descriptor</i> |                       | <i>Field Data</i>  |                    |                    |            |            |
| <i>Command</i>                    | 0x04  |   | 0x21                    |                       | U8 - Function Selector<br>U8 - Tare Axis Bitfield                            |                    |                    |            |            |
| <i>Reply Field:<br/>ACK/ NACK</i> | 0x04  |   | 0xF1                    |                       | U8 - Echo the command descriptor<br>U8 - Error code (0: ACK, non-zero: NACK) |                    |                    |            |            |
| <b>Example</b>                    | MIP Packet Header   |   |                         |                       | Command/Reply Fields   |                    |                    | Checksum   |            |
|                                   | <i>Sync1</i>  | <i>Sync2</i>  | <i>Desc. Set</i>        | <i>Payload Length</i> | <i>Field Length</i>  | <i>Field Desc.</i> | <i>Field Data</i>  | <i>MSB</i> | <i>LSB</i> |
| <i>Command</i>                    | 0x75  | 0x65  | 0x0D                    | 0x04                  | 0x04   | 0x21               | Fctn (Apply): 0x01 | 0x18       | 0x49       |

|  |             |             |             |             |             |             |  |           |           |
|--|-------------|-------------|-------------|-------------|-------------|-------------|--|-----------|-----------|
|  |             |             |             |             |             |             | X:Beta: <b>0x07</b><br>(All axis)                |           |           |
| <i>Reply Field:</i><br><i>ACK/NACK</i>                               | <b>0x75</b> | <b>0x65</b> | <b>0x0D</b> | <b>0x04</b> | <b>0x04</b> | <b>0xF1</b> | Echo cmd: <b>0x21</b><br>Error code: <b>0x00</b> | <b>0x</b> | <b>0x</b> |
| <i>Copy-Paste version of the command: "7565 0D04 0421 0107 1849"</i> |             |             |             |             |             |             |  |           |           |

### 4.3.29 Commanded Zero-Velocity Update (0x0D, 0x22)

|   |   |                         |                  |                       |  |                    |  |             |             |
|---|---|-------------------------|------------------|-----------------------|--|--------------------|--|-------------|-------------|
| <b>Description</b>  | Perform a commanded ZUPT.                   |                         |                  |                       |  |                    |  |             |             |
| <b>Notes</b>  | The maximum rate for this message is 20 Hz. |                         |                  |                       |  |                    |  |             |             |
| <b>Field Format</b>   | <i>Field Length</i>                         | <i>Field Descriptor</i> |                  |                       | <i>Field Data</i>  |                    |  |             |             |
| <i>Command</i>  | 0x02  | 0x22                    |                  |                       | N/A  |                    |  |             |             |
| <i>Reply Field:</i><br><i>ACK/NACK</i>                          | 0x04  | 0xF1                    |                  |                       | U8 - Echo the command descriptor<br>U8 - Error code (0: ACK, non-zero: NACK) |                    |  |             |             |
| <b>Example</b>  | MIP Packet Header                           |                         |                  |                       | Command/Reply Fields   |                    |  | Checksum    |             |
|   | <i>Sync1</i>                                | <i>Sync2</i>            | <i>Desc. Set</i> | <i>Payload Length</i> | <i>Field Length</i>  | <i>Field Desc.</i> | <i>Field Data</i>                                | <i>MSB</i>  | <i>LSB</i>  |
| <i>Command</i>  | <b>0x75</b>                                 | <b>0x65</b>             | <b>0x0D</b>      | <b>0x02</b>           | <b>0x02</b>  | <b>0x22</b>        |  | <b>0x0D</b> | <b>0x17</b> |
| <i>Reply Field:</i><br><i>ACK/NACK</i>                          | <b>0x75</b>                                 | <b>0x65</b>             | <b>0x0D</b>      | <b>0x04</b>           | <b>0x04</b>  | <b>0xF1</b>        | Echo cmd: <b>0x22</b><br>Error code: <b>0x00</b> | <b>0x02</b> | <b>0xF4</b> |
| <i>Copy-Paste version of the command: "7565 0D02 0222 0D17"</i> |   |                         |                  |                       |  |                    |  |             |             |

## 4.3.30 Commanded Zero-Angular Rate Update (0x0D, 0x23)

|   |   |              |                         |                       |  |                    |                                    |            |            |
|---|---|--------------|-------------------------|-----------------------|--|--------------------|------------------------------------|------------|------------|
| <b>Description</b>  | Perform a commanded zero-angular rate update. |              |                         |                       |  |                    |                                    |            |            |
| <b>Notes</b>  | The maximum rate for this message is 10 Hz.   |              |                         |                       |  |                    |                                    |            |            |
| <b>Field Format</b>   | <i>Field Length</i>                           |              | <i>Field Descriptor</i> |                       | <i>Field Data</i>  |                    |                                    |            |            |
| <i>Command</i>  | 0x02  |              | 0x23                    |                       | N/A  |                    |                                    |            |            |
| <i>Reply Field:<br/>ACK/NACK</i>                                | 0x04  |              | 0xF1                    |                       | U8 - Echo the command byte<br>U8 - Error code (0: ACK, non-zero: NACK) |                    |                                    |            |            |
| <b>Example</b>  | MIP Packet Header                             |              |                         |                       | Command/Reply Fields   |                    |                                    | Checksum   |            |
|   | <i>Sync1</i>                                  | <i>Sync2</i> | <i>Desc. Set</i>        | <i>Payload Length</i> | <i>Field Length</i>  | <i>Field Desc.</i> | <i>Field Data</i>                  | <i>MSB</i> | <i>LSB</i> |
| <i>Command</i>  | 0x75  | 0x65         | 0x0D                    | 0x02                  | 0x02   | 0x23               |                                    | 0x0E       | 0x18       |
| <i>Reply Field:<br/>ACK/NACK</i>                                | 0x75  | 0x65         | 0x0D                    | 0x04                  | 0x04   | 0xF1               | Echo cmd: 0x23<br>Error code: 0x00 | 0x03       | 0xF6       |
| <i>Copy-Paste version of the command: "7565 0D02 0223 0E18"</i> |   |              |                         |                       |  |                    |                                    |            |            |

## 4.3.31 Declination Source (0x0D, 0x43)

|  |   |                         |   |
|--|---|-------------------------|---|
| <b>Description</b>                     | <p>Set/Get the local declination angle source.</p> <p>This can be used to correct for the difference in magnetic and true north. Normally, the device reports heading with-respect-to magnetic north, but when an accurate declination angle is provided, the device will report heading with respect to true north.</p> <p>Possible function selector values:</p> <ul style="list-style-type: none"> <li>0x01 - Use new settings</li> <li>0x02 - Read back current settings.</li> <li>0x03 - Save current settings as startup settings</li> <li>0x04 - Load saved startup settings</li> <li>0x05 - Reset to factory default settings</li> </ul> <p>Possible declination sources:</p> <ul style="list-style-type: none"> <li>0x01 - None</li> <li>0x02 - World Magnetic Model (Default)</li> <li>0x03 - Manual</li> </ul> <p>Option description:</p> <p><i>None:</i> orientation information will be reported with respect to magnetic north.</p> <p><i>World Magnetic Model:</i> The declination will be sourced from the device's internal world magnetic model.</p> <p><i>Manual:</i> The user provides the declination angle. The device does not validate this angle and it is therefore up to the user to select the correct value.</p> |                         |   |
| <b>Field Format</b>                    | <i>Field Length</i>   | <i>Field Descriptor</i> | <i>Field Data</i>   |
| <i>Command</i>                         | 0x08  | 0x43                    | U8 - Function Selector<br>U8 - Declination Source<br>Float - Manual Declination angle (radians, only required if source = Manual) |
| <i>Reply Field 1:<br/>ACK/ NACK</i>    | 0x04  | 0xF1                    | U8 - Echo the command descriptor<br>U8 - Error code (0: ACK, non-zero: NACK)  |
| <i>Reply Field 2:<br/>Function = 2</i> | 0x07  | 0xB2                    | U8 - Declination Source<br>Float - Declination angle (radians)  |

| Example                                       | MIP Packet Header |       |           |                | Command/Reply Fields |             |   | Checksum |      |
|---|-------------------|-------|-----------|----------------|----------------------|-------------|---|----------|------|
|   | Sync1             | Sync2 | Desc. Set | Payload Length | Field Length         | Field Desc. | Field Data  | MSB      | LSB  |
| <i>Command</i>                                | 0x75              | 0x65  | 0x0D      | 0x08           | 0x08                 | 0x43        | Fctn (Apply): 0x01<br>Source (Manual): 0x03<br>Angle: 0x00000000 (0.0f) | 0x3E     | 0xC7 |
| <i>Reply Field 1: ACK/NACK</i>                | 0x75              | 0x65  | 0x0D      | 0x04           | 0x04                 | 0xF1        | Echo cmd: 0x43<br>Error code: 0x00                                      | 0x23     | 0x36 |
| <i>Copy-Paste version of the command: N/A</i> |                   |       |           |                |                      |             |   |          |      |

### 4.3.32 Inclination Source (0x0D, 0x4C)

|                    |  |
|--------------------|--|
| <b>Description</b> | <p>Set/Get the local inclination angle source.</p> <p>This can be used to correct for the local value of inclination (dip angle) of the earth magnetic field. Having a correct value for inclination (and declination) is important for best performance of the auto-mag calibration feature. If you do not have an accurate inclination angle source, it is recommended that you leave the auto-mag calibration feature off.</p> <p>Possible function selector values:</p> <ul style="list-style-type: none"> <li>0x01 - Use new settings</li> <li>0x02 - Read back current settings.</li> <li>0x03 - Save current settings as startup settings</li> <li>0x04 - Load saved startup settings</li> <li>0x05 - Reset to factory default settings</li> </ul> <p>Possible inclination sources:</p> <ul style="list-style-type: none"> <li>0x01 - None</li> <li>0x02 - World Magnetic Model (Default)</li> <li>0x03 - Manual</li> </ul> <p>Option description:</p> <p><i>None:</i> No inclination angle corrections are attempted.</p> <p><i>World Magnetic Model:</i> The inclination will be sourced from the device's internal world magnetic model.</p> <p><i>Manual:</i> The user provides the inclination angle. The device does not validate this angle and it is therefore up to the user to select the correct</p> |
|--------------------|--|

## 4.3.32 Inclination Source (0x0D, 0x4C)

| 4.3.32 Inclination Source (0x0D, 0x4C) |                   |                  |           |                |   |             |   |          |      |
|--|-------------------|------------------|-----------|----------------|---|-------------|---|----------|------|
|  | value.            |                  |           |                |   |             |   |          |      |
| Field Format                           | Field Length      | Field Descriptor |           |                | Field Data  |             |   |          |      |
| Command                                | 0x08              | 0x4C             |           |                | U8 - Function Selector<br>U8 - Inclination Source<br>Float - Manual Inclination angle (radians, only required if source = Manual) |             |   |          |      |
| Reply Field 1:<br>ACK/NACK             | 0x04              | 0xF1             |           |                | U8 - Echo the command descriptor<br>U8 - Error code (0: ACK, non-zero: NACK)  |             |   |          |      |
| Reply Field 2:<br>Function = 2         | 0x07              | 0xBC             |           |                | U8 - Inclination Source<br>Float - Inclination angle (radians)  |             |   |          |      |
| Example                                | MIP Packet Header |                  |           |                | Command/Reply Fields  |             |   | Checksum |      |
|  | Sync1             | Sync2            | Desc. Set | Payload Length | Field Length  | Field Desc. | Field Data  | MSB      | LSB  |
| Command                                | (x75              | 0x65             | 0x0D      | 0x08           | 0x08  | 0x4C        | Fctn (Apply): 0x01<br>Source (Manual): 0x03<br>Angle: 0x00000000 (0.0f) | 0x47     | 0x06 |
| Reply Field 1:<br>ACK/NACK             | (x75              | 0x65             | 0x0D      | 0x04           | 0x04  | 0xF1        | Echo cmd: 0x4C<br>Error code: 0x00                                      | 0x2C     | 0x48 |
| Copy-Paste version of the command: N/A |                   |                  |           |                |   |             |   |          |      |

## 4.3.33 Magnetic Field Magnitude Source (0x0D, 0x4D)

|             |   |
|-------------|---|
| Description | Set/Get the local magnetic field magnitude source.  |
|             | <p>This is used to specify the local magnitude of the earth's magnetic field. It is important for best performance of the auto-mag calibration feature and for the magnetometer adaptive magnitude. If you do not have an accurate value for the local magnetic field magnitude, it is recommended that you leave the auto-mag calibration feature off.</p> <p>Possible function selector values:</p> <p>0x01 - Use new settings<br/>0x02 - Read back current settings.</p> |

## 4.3.33 Magnetic Field Magnitude Source (0x0D, 0x4D)

|   | <p>0x03 - Save current settings as startup settings<br/> 0x04 - Load saved startup settings<br/> 0x05 - Reset to factory default settings</p> <p>Possible magnetic field magnitude sources:</p> <p>0x01 - None<br/> 0x02 - World Magnetic Model (Default)<br/> 0x03 - Manual</p> <p>Option description:</p> <p><i>None:</i> A fixed value of 0.5 Gauss is used.<br/> <i>World Magnetic Model:</i> The magnitude will be sourced from the device's internal world magnetic model.<br/> <i>Manual:</i> The user provides the magnitude. The device does not constrain this value and it is therefore up to the user to select an accurate value.</p> |                  |           |                |  |             |   |          |      |
|---|--|------------------|-----------|----------------|--|-------------|---|----------|------|
| Field Format  | Field Length   | Field Descriptor |           |                | Field Data   |             |   |          |      |
| Command   | 0x08   | 0x4D             |           |                | U8 - Function Selector<br>U8 - Magnetic Field Magnitude Source<br>Float - Manual Magnitude (Gauss, only required if source = Manual) |             |   |          |      |
| Reply Field 1:<br>ACK/NACK  | 0x04   | 0xF1             |           |                | U8 - Echo the command descriptor<br>U8 - Error code (0: ACK, non-zero: NACK)   |             |   |          |      |
| Reply Field 2:<br>Function = 2  | 0x07   | 0xBD             |           |                | U8 - Inclination Source<br>Float - Magnitude (Gauss)   |             |   |          |      |
| Example   | MIP Packet Header  |                  |           |                | Command/Reply Fields   |             |   | Checksum |      |
|   | Sync1  | Sync2            | Desc. Set | Payload Length | Field Length   | Field Desc. | Field Data  | MSB      | LSB  |
| Command   | 0x75   | 0x65             | 0x0D      | 0x08           | 0x08   | 0x4D        | Fctn (Apply): 0x01<br>Source (Manual): 0x03<br>Angle: 0x3F000000 (0.0f) | 0x87     | 0x09 |
| Reply Field 1:<br>ACK/NACK  | 0x75   | 0x65             | 0x0D      | 0x04           | 0x04   | 0xF1        | Echo cmd: 0x4D<br>Error code: 0x00                                      | 0x2D     | 0x4A |
| Copy-Paste version of the command: 7565 0D08 084D 0103 3F00 0000 8709 |  |                  |           |                |  |             |   |          |      |



## 4.3.34 Gravity Magnitude Error Adaptive Measurement (0x0D, 0x44)

|                     |   |                         |   |
|---------------------|---|-------------------------|---|
| <b>Description</b>  | <p>Enable or disable the gravity<sup>1</sup> magnitude error adaptive measurement feature. This function can be used to tune the filter performance in the target application.</p> <p>Possible function selector values:</p> <ul style="list-style-type: none"> <li>0x01 - Use new settings</li> <li>0x02 - Read back current settings.</li> <li>0x03 - Save current settings as startup settings</li> <li>0x04 - Load saved startup settings</li> <li>0x05 - Reset to factory default settings</li> </ul> <p>Possible adaptive measurement selector values:</p> <ul style="list-style-type: none"> <li>0x00 - No adaptive measurement (disable)</li> <li>0x01 - Enable fixed adaptive measurement (use specified limits)</li> <li>0x02 - Enable auto adaptive measurement<sup>2</sup></li> </ul> <p>Filter and limit parameters (only used for enable option 1):</p> <p>Pick values that give you the least occurrence of invalid EF attitude output. The default values are good for standard low vibration applications. Increase values for higher vibration conditions, lower values for lower vibration. Too low a value will result in excessive heading errors. Higher values increase pitch and roll errors when undergoing linear accelerations.</p> <p>Adaptive measurements can be enabled/disabled without the need for providing the additional parameters. In this case, only the function selector and enable value are required; all other parameters will remain at their previous values. When “auto-adaptive” is selected, the filter and limit parameters are ignored. Instead, aiding measurements which rely on the gravity vector will be automatically reweighted by the Kalman filter according to the perceived measurement quality.</p> |                         |   |
| <b>Notes</b>        | <ol style="list-style-type: none"> <li>1. This command is also referred to as "Accelerometer Magnitude Error Adaptive Measurement."</li> <li>2. Enable option 2 (auto-adaptive) is only available on 3DM-GX5 and later.</li> </ol>  |                         |   |
| <b>Field Format</b> | <i>Field Length</i>   | <i>Field Descriptor</i> | <i>Field Data</i>   |
| <i>Command</i>      | 0x1C  | 0x44                    | U8 - Function Selector<br>U8 - Disable/Fixed/Auto<br>Float - Low-pass filter cutoff frequency (Hz)<br>Float - Low Limit (meters/second <sup>2</sup> )<br>Float - High Limit (meters/second <sup>2</sup> )<br>Float - Low Limit Uncertainty, 1-Sigma (meters/second <sup>2</sup> ) |

|  |                   |              |                  |                       |                      |                    | Float - High Limit Uncertainty, 1-Sigma (meters/second <sup>2</sup> )<br>Float - Minimum Uncertainty, 1-Sigma (meters/second <sup>2</sup> )   |            |            |
|--|-------------------|--------------|------------------|-----------------------|----------------------|--------------------|---|------------|------------|
| <i>Reply Field 1:<br/>ACK/NACK</i>     | 0x04              |              | 0xF1             |                       |                      |                    | U8 - Echo the command descriptor<br>U8 - Error code (0: ACK, non-zero: NACK)  |            |            |
| <i>Reply Field 2:<br/>Function = 2</i> | 0x1B              |              | 0xB3             |                       |                      |                    | U8 - Enable (0: Disable, 1: Fixed or Manual, 2: Auto-Adaptive)<br>Float - Low-pass filter cutoff frequency (Hz)<br>Float - Low Limit (meters/second <sup>2</sup> )<br>Float - High Limit (meters/second <sup>2</sup> )<br>Float - Low Limit Uncertainty, 1-Sigma (meters/second <sup>2</sup> )<br>Float - High Limit Uncertainty, 1-Sigma (meters/second <sup>2</sup> )<br>Float - Minimum Uncertainty, 1-Sigma (meters/second <sup>2</sup> ) |            |            |
| Example                                | MIP Packet Header |              |                  |                       | Command/Reply Fields |                    |   | Checksum   |            |
|  | <i>Sync1</i>      | <i>Sync2</i> | <i>Desc. Set</i> | <i>Payload Length</i> | <i>Field Length</i>  | <i>Field Desc.</i> | <i>Field Data</i>   | <i>MSB</i> | <i>LSB</i> |
| <i>Command</i>                         | 0x75              | 0x65         | 0x0D             | 0x1C                  | 0x1C                 | 0x44               | Fctn (Apply): 0x01<br>Enable: 0x01<br>Freq (Hz): (1.0f)<br>Low Limit: (-0.2f)<br>High Limit: (0.2f)<br>Low Limit 1-sigma: (0.2f)<br>High Limit 1-sigma: (0.2f)<br>Min 1-sigma: (0.004f)   | -          | -          |
| <i>Reply Field 1:<br/>ACK/NACK</i>     | 0x75              | 0x65         | 0x0D             | 0x04                  | 0x04                 | 0xF1               | Echo cmd: 0x44<br>Error code: 0x00  | 0xB2       | 0xE2       |

## 4.3.35 Magnetometer Magnitude Error Adaptive Measurement (0x0D, 0x45)

|                     |  |                         |   |
|---------------------|--|-------------------------|---|
| <b>Description</b>  | <p>Enable or disable the magnetometer magnitude error adaptive measurement. This feature will reject magnetometer readings that are out of range of the thresholds specified (fixed adaptive) or calculated internally (auto-adaptive).</p> <p>Possible function selector values:</p> <ul style="list-style-type: none"> <li>0x01 - Use new settings</li> <li>0x02 - Read back current settings.</li> <li>0x03 - Save current settings as startup settings</li> <li>0x04 - Load saved startup settings</li> <li>0x05 - Reset to factory default settings</li> </ul> <p>Possible adaptive measurement selector values:</p> <ul style="list-style-type: none"> <li>0x00 - No adaptive measurement (disable)</li> <li>0x01 - Enable fixed adaptive measurement (use specified limits)</li> <li>0x02 - Enable auto adaptive measurement<sup>1</sup></li> </ul> <p>Filter and limit parameters (only used for enable option 1):</p> <p>Pick values that give you the least occurrence of invalid EF attitude output. The default values are good for standard low dynamics applications. Increase values for higher dynamic conditions, lower values for lower dynamic. Too low a value will result in excessive heading errors. Higher values increase heading errors when undergoing magnetic field anomalies caused by DC currents, magnets, steel structures, etc.</p> <p>Auto-adaptive measurements can be enabled without the need for providing the additional parameters. In this case, only the function selector and enable value are required; all other parameters will remain at their previous values. When “auto-adaptive” is selected, the filter and limit parameters are ignored. Instead, aiding measurements which rely on the magnetometers will be automatically re-weighted by the Kalman filter according to the perceived measurement quality.</p> |                         |   |
| <b>Notes</b>        | <p>1. Enable value 2 (auto-adaptive) is only available on 3DM -GX5 and later devices.</p>  |                         |   |
| <b>Field Format</b> | <i>Field Length</i>  | <i>Field Descriptor</i> | <i>Field Data</i>   |
| <i>Command</i>      | 0x1C   | 0x45                    | U8 - Function Selector<br>U8 - Disable/Fixed/Auto<br>Float - Low-pass filter cutoff frequency (Hz)<br>Float - Low Limit (meters/second <sup>2</sup> )<br>Float - High Limit (meters/second <sup>2</sup> )<br>Float - Low Limit Uncertainty, 1-Sigma (meters/second <sup>2</sup> ) |

|  |                   |              |                  |                       |                      |                    | Float - High Limit Uncertainty, 1-Sigma (meters/second <sup>2</sup> )<br>Float - Minimum Uncertainty, 1-Sigma (meters/second <sup>2</sup> )   |            |            |
|--|-------------------|--------------|------------------|-----------------------|----------------------|--------------------|---|------------|------------|
| <i>Reply Field 1:<br/>ACK/NACK</i>     | 0x04              |              | 0xF1             |                       |                      |                    | U8 - Echo the command descriptor<br>U8 - Error code (0: ACK, non-zero: NACK)  |            |            |
| <i>Reply Field 2:<br/>Function = 2</i> | 0x1B              |              | 0xB4             |                       |                      |                    | U8 - Enable (0: Disable, 1: Fixed or Manual, 2: Auto-Adaptive)<br><br>Float - Low-pass filter cutoff frequency (Hz)<br>Float - Low Limit (Gauss)<br>Float - High Limit (Gauss)<br>Float - Low Limit Uncertainty, 1-Sigma (Gauss)<br>Float - High Limit Uncertainty, 1-Sigma (Gauss)<br>Float - Minimum Uncertainty, 1-Sigma (Gauss) |            |            |
| Example                                | MIP Packet Header |              |                  |                       | Command/Reply Fields |                    |   | Checksum   |            |
|  | <i>Sync1</i>      | <i>Sync2</i> | <i>Desc. Set</i> | <i>Payload Length</i> | <i>Field Length</i>  | <i>Field Desc.</i> | <i>Field Data</i>   | <i>MSB</i> | <i>LSB</i> |
| <i>Command</i>                         | 0x75              | 0x65         | 0x0D             | 0x1C                  | 0x1C                 | 0x45               | Fctn (Apply): <b>0x01</b><br>Enable: <b>0x01</b><br>Freq (Hz): <b>(1.0f)</b><br>Low Limit: <b>(-0.2f)</b><br>High Limit: <b>(0.2f)</b><br>Low Limit 1-sigma: <b>(0.2f)</b><br>High Limit 1-sigma: <b>(0.2f)</b><br>Min 1-sigma: <b>(0.004f)</b>   | -          | -          |
| <i>Reply Field:<br/>ACK/NACK</i>       | 0x75              | 0x65         | 0x0D             | 0x04                  | 0x04                 | 0xF1               | Echo cmd: <b>0x45</b><br>Error code: <b>0x00</b>  | 0xB3       | 0xE4       |

## 4.3.36 Magnetometer Dip Angle Error Adaptive Measurement (0x0D, 0x46)

|  |   |                         |   |
|--|---|-------------------------|---|
| <b>Description</b>                     | <p>Enable or disable the magnetometer magnitude error adaptive measurement. This feature will reject magnetometer readings that are out of range of the thresholds specified<sup>1</sup>.</p> <p>Possible function selector values:</p> <ul style="list-style-type: none"> <li>0x01 - Use new settings</li> <li>0x02 - Read back current settings.</li> <li>0x03 - Save current settings as startup settings</li> <li>0x04 - Load saved startup settings</li> <li>0x05 - Reset to factory default settings</li> </ul> <p>Possible adaptive enable options:</p> <ul style="list-style-type: none"> <li>0x00 - No adaptive measurement (disable)</li> <li>0x01 - Enable fixed adaptive measurement (use specified limits)</li> </ul> <p>Filter and limit parameters:</p> <p>Pick values that give you the least occurrence of invalid EF attitude output. The default values are good for standard low dynamics applications. Increase values for higher dynamic conditions, lower values for lower dynamic. Too low a value will result in excessive heading errors. Higher values increase heading errors when undergoing magnetic field anomalies caused by DC currents, magnets, steel structures, etc.</p> |                         |   |
| <b>Notes</b>                           | <p>1. The magnetometer dip angle adaptive measurement is ignored if the auto-adaptive magnetometer magnitude or auto-adaptive accel magnitude options are selected.</p>   |                         |   |
| <b>Field Format</b>                    | <i>Field Length</i>   | <i>Field Descriptor</i> | <i>Field Data</i>   |
| <i>Command</i>                         | 0x14  | 0x46                    | U8 - Function Selector<br>U8 - Enable (0 - Disable, 1 - Enable)<br>Float - Low-pass filter cutoff frequency (Hz)<br>Float - High Limit (Radians)<br>Float - High Limit Uncertainty, 1-Sigma (Gauss)<br>Float - Minimum Uncertainty, 1-Sigma (Gauss) |
| <i>Reply Field 1:<br/>ACK/NACK</i>     | 0x04  | 0xF1                    | U8 - Echo the command descriptor<br>U8 - Error code (0: ACK, non-zero: NACK)  |
| <i>Reply Field 2:<br/>Function = 2</i> | 0x13  | 0xB5                    | U8 - Enable (0 - Disable, 1 - Enable)<br>Float - Low-pass filter cutoff frequency (Hz)<br>Float - High Limit (Radians)<br>Float - High Limit Uncertainty, 1-Sigma (Gauss)<br>Float - Minimum Uncertainty, 1-Sigma (Gauss)                           |

| Example                            | MIP Packet Header |              |                  |                       | Command/Reply Fields |                    |   | Checksum   |            |
|------------------------------------|-------------------|--------------|------------------|-----------------------|----------------------|--------------------|---|------------|------------|
|                                    | <i>Sync1</i>      | <i>Sync2</i> | <i>Desc. Set</i> | <i>Payload Length</i> | <i>Field Length</i>  | <i>Field Desc.</i> | <i>Field Data</i>   | <i>MSB</i> | <i>LSB</i> |
| <i>Command</i>                     | 0x75              | 0x65         | 0x0D             | 0x14                  | 0x14                 | 0x46               | Fctn (Apply): 0x01<br>Enable: 0x01<br>Freq (Hz) (10.0f)<br>High Limit (rad): (0.3f)<br>High Limit 1-sigma: (0.2f)<br>Min 1-sigma: (0.01f) | -          | -          |
| <i>Reply Field 1:<br/>ACK/NACK</i> | 0x75              | 0x65         | 0x0D             | 0x04                  | 0x04                 | 0xF1               | Echo cmd: 0x46<br>Error code: 0x00  | 0xB4       | 0xE6       |

## 4.3.37 Magnetometer Capture Auto Calibration (0x0D, 0x27)

|  |  |                         |                  |                       |  |                    |                                    |            |            |
|--|--|-------------------------|------------------|-----------------------|--|--------------------|------------------------------------|------------|------------|
| <b>Description</b>   | <p>This command captures the current value of the auto-calibration, applies it to the current fixed hard and soft iron calibration coefficients, and replaces the current fixed hard and soft iron calibration coefficients with the new values.</p> <p>This may be used in place of (or in addition to) a manual hard and soft iron calibration utility such as <i>MIP Iron Calibration</i>. This command also resets the auto-calibration coefficients.</p> <p>Function selector values:</p> <p style="padding-left: 40px;">0x01 - Capture and use new settings<br/>0x03 - Save current settings as startup settings<sup>1</sup></p> |                         |                  |                       |  |                    |                                    |            |            |
| <b>Notes</b>   | 1.This is the same as issuing the 0x0C, 0x3A and 0x0C, 0x3B commands with the “0x03 - Save current settings as startup settings” function selector.  |                         |                  |                       |  |                    |                                    |            |            |
| <b>Field Format</b>  | <i>Field Length</i>  | <i>Field Descriptor</i> |                  |                       | <i>Field Data</i>  |                    |                                    |            |            |
| <i>Command</i>   | 0x27   | 0x27                    |                  |                       | U8 - Function Selector   |                    |                                    |            |            |
| <i>Reply Field: ACK/NACK</i>                                       | 0x04   | 0xF1                    |                  |                       | U8 - Echo the command descriptor<br>U8 - Error code (0: ACK, non-zero: NACK) |                    |                                    |            |            |
| <b>Example</b>   | MIP Packet Header  |                         |                  |                       | Command/Reply Fields   |                    |                                    | Checksum   |            |
|  | <i>Sync1</i>   | <i>Sync2</i>            | <i>Desc. Set</i> | <i>Payload Length</i> | <i>Field Length</i>  | <i>Field Desc.</i> | <i>Field Data</i>                  | <i>MSB</i> | <i>LSB</i> |
| <i>Command</i>   | 0x75   | 0x65                    | 0x0D             | 0x02                  | 0x02   | 0x27               | Selector: 01                       | 0x15       | 0x36       |
| <i>Reply Field: ACK/NACK</i>                                       | 0x75   | 0x65                    | 0x0D             | 0x04                  | 0x04   | 0xF1               | Echo cmd: 0x27<br>Error code: 0x00 | 0x95       | 0xA8       |
| <i>Copy-Paste version of the command: "7565 0D03 0327 0115 36"</i> |  |                         |                  |                       |  |                    |                                    |            |            |

## 4.4 System Commands

The System Command set provides a set of advanced commands that are specific to devices such as the 3DM-GX5-45 that have multiple intelligent internal sensor blocks. These commands allow special modes such as talking directly to the native protocols of the embedded sensor blocks. For example, with the 3DM-GX5-45, you may switch into a mode that talks directly to another LORD Sensing Inertial Sensor with an internal IMU.

### 4.4.1 Communication Mode (0x7F, 0x10)

*Advanced*

| <p><b>Description</b></p>    | <p>Advanced specialized communication modes.</p> <p>This will change the communications protocol to and from “Estimation Filter” mode to “GNSS Direct” (u-bloxM8M protocols on the 3DM-GX5-45). This command is always active, even when switched to the direct modes. This command responds with an ACK/NACK just prior to switching to the new protocol. For all functions except 0x01 (use new settings), the new communications mode value is ignored.</p> <p>Possible function selector values:</p> <ul style="list-style-type: none"> <li>0x01 - Apply new settings</li> <li>0x02 - Read back current settings</li> <li>0x03 - Save current settings as startup settings</li> <li>0x04 - Load saved startup settings</li> <li>0x05 - Reset to factory default settings</li> </ul> <p>Possible Communications Modes:</p> <table border="1" data-bbox="446 1276 1403 1423"> <thead> <tr> <th>Value</th> <th>Mode</th> <th>Protocol(s)</th> </tr> </thead> <tbody> <tr> <td>0x01</td> <td>Standard</td> <td>3DM-GX5-45 MIP Packet <i>(default)</i></td> </tr> <tr> <td>0x02</td> <td>Sensor Direct</td> <td>MIP IMU</td> </tr> <tr> <td>0x03</td> <td>GNSS Direct</td> <td>NMEA, UBX (GNSS Models only)</td> </tr> </tbody> </table> |  |  | Value | Mode | Protocol(s) | 0x01 | Standard | 3DM-GX5-45 MIP Packet <i>(default)</i> | 0x02 | Sensor Direct | MIP IMU | 0x03 | GNSS Direct | NMEA, UBX (GNSS Models only) |
|------------------------------|---|--|--|-------|------|-------------|------|----------|--|------|---------------|---------|------|-------------|------------------------------|
| Value                        | Mode  | Protocol(s)                            |  |       |      |             |      |          |  |      |               |         |      |             |                              |
| 0x01                         | Standard  | 3DM-GX5-45 MIP Packet <i>(default)</i> |  |       |      |             |      |          |  |      |               |         |      |             |                              |
| 0x02                         | Sensor Direct   | MIP IMU                                |  |       |      |             |      |          |  |      |               |         |      |             |                              |
| 0x03                         | GNSS Direct   | NMEA, UBX (GNSS Models only)           |  |       |      |             |      |          |  |      |               |         |      |             |                              |
| <p><b>Notes</b></p>          | <p><i>IMPORTANT: GNSS message settings are automatically reloaded when switching from direct modes back into standard mode.</i></p> <p><i>Note: Switching to and from GNSS Direct Mode takes longer than most commands to complete due to the amount of GNSS setup data that needs to be stored/retrieved.</i></p>  |  |  |       |      |             |      |          |  |      |               |         |      |             |                              |
| <p><b>Field Format</b></p>   | <p><i>Field Length</i></p>  | <p><i>Field Descriptor</i></p>         | <p><i>Field Data</i></p>                                       |       |      |             |      |          |  |      |               |         |      |             |                              |
| <p><i>Command</i></p>        | <p>0x04</p>   | <p>0x10</p>                            | <p>U8 - Function selector<br/>U8 - New Communications Mode</p> |       |      |             |      |          |  |      |               |         |      |             |                              |
| <p><i>Reply Field 1:</i></p> | <p>0x04</p>   | <p>0xF1</p>                            | <p>U8 - Echo the command descriptor</p>                        |       |      |             |      |          |  |      |               |         |      |             |                              |



|  |                   |              |  |                                  |                      |                    |   |            |            |
|--|-------------------|--------------|--|----------------------------------|----------------------|--------------------|---|------------|------------|
| <i>ACK/NACK</i>  |                   |              | U8 - Error code (0: ACK, non-zero: NACK) |                                  |                      |                    |   |            |            |
| <i>Reply Field 2:<br/>Function = 2</i>                               | 0x03              | 0x90         |  | U8 - Current Communications Mode |                      |                    |   |            |            |
| <b>Example</b>   | MIP Packet Header |              |  |                                  | Command/Reply Fields |                    |   | Checksum   |            |
|  | <i>Sync1</i>      | <i>Sync2</i> | <i>Desc. Set</i>                         | <i>Payload Length</i>            | <i>Field Length</i>  | <i>Field Desc.</i> | <i>Field Data</i>                               | <i>MSB</i> | <i>LSB</i> |
| <i>Command</i>   | 0x75              | 0x65         | 0x7F                                     | 0x04                             | 0x04                 | 0x10               | Fctn (USE): 0x01<br>New mode (IMU direct): 0x02 | 0x74       | 0xBD       |
| <i>Reply Field 1:<br/>ACK/NACK</i>                                   | 0x75              | 0x65         | 0x7F                                     | 0x04                             | 0x04                 | 0xF1               | Echo cmd: 0x10<br>Error code: 0x00              | 0x62       | 0x7C       |
| <i>Copy-Paste version of the command: "7565 7F04 0410 0102 74BD"</i> |                   |              |  |                                  |                      |                    |   |            |            |

#### 4.5 Error Codes

| <i>Error Name</i>     | <i>Error Value</i> | <i>Description</i>   |
|-----------------------|--------------------|--|
| MIP Unknown Command   | 0x01               | The command descriptor is not supported by this device   |
| MIP Invalid Checksum  | 0x02               | An otherwise complete packet has a bad checksum  |
| MIP Invalid Parameter | 0x03               | One or more parameters in the packet are invalid. This can refer to a value that is outside the allowed range for a command or a value that is not the expected size or type |
| MIP Command Failed    | 0x04               | Device could not complete the command  |
| MIP Command Timeout   | 0x05               | Device could not complete the command within the expected time   |

## 5 Data Reference

### 5.1 IMU Data

#### 5.1.1 Scaled Accelerometer Vector (0x80, 0x04)

| 5.1.1 Scaled Accelerometer Vector (0x80, 0x04) |   |                        |                       |                    |                  |              |
|--|---|------------------------|-----------------------|--------------------|------------------|--------------|
| <b>Description</b>                             | Scaled Accelerometer Vector   |                        |                       |                    |                  |              |
| <b>Notes</b>                                   | This is a vector quantifying the direction and magnitude of the acceleration that the 3DM-GX5-45 is exposed to. This quantity is fully temperature compensated and scaled into physical units of g (1 g = 9.80665 m/sec <sup>2</sup> ). It is expressed in terms of the 3DM-GX5-45's local coordinate system. |                        |                       |                    |                  |              |
| <b>Field Format</b>                            | <i>Field Length</i>   | <i>Data Descriptor</i> | <i>Message Data</i>   |                    |                  |              |
|  | 14 (0x0E)   | 0x04                   | <i>Binary Off-set</i> | <i>Description</i> | <i>Data Type</i> | <i>Units</i> |
|  |   |                        | 0                     | X Accel            | float            | g            |
|  |   |                        | 4                     | Y Accel            | float            | g            |
|  |   | 8                      | Z Accel               | float              | g                |              |

### 5.1.2 Scaled Gyro Vector (0x80, 0x05)

|                     |   |                        |                      |                    |                  |                |
|---------------------|---|------------------------|----------------------|--------------------|------------------|----------------|
| <b>Description</b>  | Scaled Gyro Vector  |                        |                      |                    |                  |                |
| <b>Notes</b>        | This is a vector quantifying the rate of rotation (angular rate) of the 3DM-GX5-45. This quantity is fully temperature compensated and scaled into units of radians/second. It is expressed in terms of the 3DM-GX5-45's local coordinate system. |                        |                      |                    |                  |                |
| <b>Field Format</b> | <i>Field Length</i>   | <i>Data Descriptor</i> | <i>Message Data</i>  |                    |                  |                |
|                     | 14 (0x0E)   | 0x05                   | <i>Binary Offset</i> | <i>Description</i> | <i>Data Type</i> | <i>Units</i>   |
|                     |   |                        | 0                    | X Gyro             | float            | Radians/second |
|                     |   |                        | 4                    | Y Gyro             | float            | Radians/second |
|                     |   |                        | 8                    | Z Gyro             | float            | Radians/second |

### 5.1.3 Scaled Magnetometer Vector (0x80, 0x06)

|                     |   |                        |                      |                    |                  |              |
|---------------------|---|------------------------|----------------------|--------------------|------------------|--------------|
| <b>Description</b>  | Scaled Magnetometer Vector  |                        |                      |                    |                  |              |
| <b>Notes</b>        | This is a vector which gives the instantaneous magnetometer direction and magnitude. This quantity is fully temperature compensated and scaled into units of Gauss. It is expressed in terms of the 3DM-GX5-45's local coordinate system. |                        |                      |                    |                  |              |
| <b>Field Format</b> | <i>Field Length</i>   | <i>Data Descriptor</i> | <i>Message Data</i>  |                    |                  |              |
|                     | 14 (0x0E)   | 0x06                   | <i>Binary Offset</i> | <i>Description</i> | <i>Data Type</i> | <i>Units</i> |
|                     |   |                        | 0                    | X Mag              | float            | Gauss        |
|                     |   |                        | 4                    | Y Mag              | float            | Gauss        |
|                     |   |                        | 8                    | Z Mag              | float            | Gauss        |

### 5.1.4 Scaled Ambient Pressure (0x80, 0x17)

|                     |  |                        |                      |                    |                  |              |
|---------------------|--|------------------------|----------------------|--------------------|------------------|--------------|
| <b>Description</b>  | Scaled Ambient Vector  |                        |                      |                    |                  |              |
| <b>Notes</b>        | This is a scalar which gives the instantaneous ambient pressure reading. This quantity is fully temperature compensated and scaled into units of milliBar. |                        |                      |                    |                  |              |
| <b>Field Format</b> | <i>Field Length</i>  | <i>Data Descriptor</i> | <i>Message Data</i>  |                    |                  |              |
|                     | 06 (0x06)  | 0x17                   | <i>Binary Offset</i> | <i>Description</i> | <i>Data Type</i> | <i>Units</i> |
|                     |  |                        | 0                    | Ambient Pressure   | float            | milliBar     |

### 5.1.5 Delta Theta Vector (0x80, 0x07)

|                     |   |                        |                      |                    |                  |              |
|---------------------|---|------------------------|----------------------|--------------------|------------------|--------------|
| <b>Description</b>  | Time integral of angular rate.  |                        |                      |                    |                  |              |
| <b>Notes</b>        | This is a vector which gives the time integral of angular rate over the interval set by the IMU message format command. It is expressed in terms of the 3DM-GX5-45's local coordinate system in units of radians. |                        |                      |                    |                  |              |
| <b>Field Format</b> | <i>Field Length</i>   | <i>Data Descriptor</i> | <i>Message Data</i>  |                    |                  |              |
|                     | 14 (0x0E)   | 0x07                   | <i>Binary Offset</i> | <i>Description</i> | <i>Data Type</i> | <i>Units</i> |
|                     |   |                        | 0                    | X Delta Theta      | float            | radians      |
|                     |   |                        | 4                    | Y Delta Theta      | float            | radians      |
| 8                   | Z Delta Theta   | float                  | radians              |                    |                  |              |

### 5.1.6 Delta Velocity Vector (0x80, 0x08)

|                     |  |                        |                      |                    |                  |              |
|---------------------|--|------------------------|----------------------|--------------------|------------------|--------------|
| <b>Description</b>  | Time integral of acceleration.   |                        |                      |                    |                  |              |
| <b>Notes</b>        | This is a vector which gives the time integral of specific acceleration over the interval set by the IMU message format command. It is expressed in terms of the 3DM-GX5-45's local coordinate system in units of g*second where g is the standard gravitational constant. To convert Delta Velocity into the more conventional units of m/sec, simply multiply by the standard gravitational constant, 9.80665 m/sec <sup>2</sup> . |                        |                      |                    |                  |              |
| <b>Field Format</b> | <i>Field Length</i>  | <i>Data Descriptor</i> | <i>Message Data</i>  |                    |                  |              |
|                     | 14 (0x0E)  | 0x08                   | <i>Binary Offset</i> | <i>Description</i> | <i>Data Type</i> | <i>Units</i> |
|                     |  |                        | 0                    | X Delta Velocity   | float            | g*seconds    |
|                     |  |                        | 4                    | Y Delta Velocity   | float            | g*seconds    |
|                     |  |                        | 8                    | Z Delta Velocity   | float            | g*seconds    |

### 5.1.7 CF Orientation Matrix (0x80, 0x09)

|                    |   |
|--------------------|---|
| <b>Description</b> | 3 x 3 Orientation Matrix $M$ .<br><i>This value is produced by the Complementary Filter fusion algorithm.</i>   |
| <b>Notes</b>       | <p>This is a nine component coordinate transformation matrix which describes the orientation of the 3DM-GX5 with respect to the fixed earth coordinate system.</p> $M = \begin{bmatrix} M_{1,1} & M_{1,2} & M_{1,3} \\ M_{2,1} & M_{2,2} & M_{2,3} \\ M_{3,1} & M_{3,2} & M_{3,3} \end{bmatrix}$ <p><math>M</math> satisfies the following equation:</p> $V\_IL_i = M_{ij} \cdot V\_E_j$ <p>Where:</p> <p><math>V\_IL</math> is a vector expressed in the 3DM- GX5's local coordinate system.</p> |

## 5.1.7 CF Orientation Matrix (0x80, 0x09)

| 5.1.7 CF Orientation Matrix (0x80, 0x09) |  |                 |                  |                  |           |       |
|--|--|-----------------|------------------|------------------|-----------|-------|
|  | V_E is the same vector expressed in the stationary, earth- fixed coordinate system |                 |                  |                  |           |       |
| Field Format                             | Field Length   | Data Descriptor | Message Data     |                  |           |       |
|  | 38 (0x26)  | 0x09            | Binary Off-set   | Description      | Data Type | Units |
|  |  |                 | 0                | M <sub>1,1</sub> | Float     | N/A   |
|  |  |                 | 4                | M <sub>1,2</sub> | Float     | N/A   |
|  |  |                 | 8                | M <sub>1,3</sub> | Float     | N/A   |
|  |  |                 | 12               | M <sub>2,1</sub> | Float     | N/A   |
|  |  |                 | 16               | M <sub>2,2</sub> | Float     | N/A   |
|  |  |                 | 20               | M <sub>2,3</sub> | Float     | N/A   |
|  |  |                 | 24               | M <sub>3,1</sub> | Float     | N/A   |
|  |  |                 | 28               | M <sub>3,2</sub> | Float     | N/A   |
| 32                                       |  |                 | M <sub>3,3</sub> | Float            | N/A       |       |

## 5.1.8 CF Quaternion (0x80, 0x0A)

|                     |   |                        |                       |                    |                  |              |
|---------------------|---|------------------------|-----------------------|--------------------|------------------|--------------|
| <b>Description</b>  | 4 x 1 quaternion Q.<br><i>This value is produced by the Complementary Filter fusion algorithm.</i>  |                        |                       |                    |                  |              |
| <b>Notes</b>        | <p>This is a four component quaternion which describes the orientation of the 3DM-GX5 with respect to the fixed earth coordinate system.</p> $Q = \begin{bmatrix} q_0 \\ q_1 \\ q_2 \\ q_3 \end{bmatrix}$ <p>Q satisfies the following equation:</p> $V_{IL_i} = Q^{-1} \cdot V_E \cdot Q$ <p>Where:</p> <p><math>V_{IL}</math> is a vector expressed in the 3DM- GX5's local coordinate system.</p> <p><math>V_E</math> is the same vector expressed in the stationary, earth- fixed coordinate system</p> |                        |                       |                    |                  |              |
| <b>Field Format</b> | <i>Field Length</i>   | <i>Data Descriptor</i> | <i>Message Data</i>   |                    |                  |              |
|                     | 18 (0x12)   | 0x0A                   | <i>Binary Off-set</i> | <i>Description</i> | <i>Data Type</i> | <i>Units</i> |
|                     |   |                        | 0                     | q <sub>0</sub>     | Float            | N/A          |
|                     |   |                        | 4                     | q <sub>1</sub>     | Float            | N/A          |
|                     |   |                        | 8                     | q <sub>2</sub>     | Float            | N/A          |
| 12                  | q <sub>3</sub>  | Float                  | N/A                   |                    |                  |              |

## 5.1.9 CF Euler Angles (0x80, 0x0C)

|                     |   |                        |                      |                    |                  |              |
|---------------------|---|------------------------|----------------------|--------------------|------------------|--------------|
| <b>Description</b>  | Pitch, Roll, and Yaw (aircraft) values.<br><i>This value is produced by the Complementary Filter fusion algorithm.</i>  |                        |                      |                    |                  |              |
| <b>Notes</b>        | This is a three component vector containing the Roll, Pitch and Yaw angles in radians. It is computed by the IMU/AHRS from the orientation matrix $M$ .<br>$Euler = \begin{bmatrix} Roll \\ Pitch \\ Yaw \end{bmatrix}$ |                        |                      |                    |                  |              |
| <b>Field Format</b> | <i>Field Length</i>   | <i>Data Descriptor</i> | <i>Message Data</i>  |                    |                  |              |
|                     | 14 (0x0E)   | 0x0C                   | <i>Binary Offset</i> | <i>Description</i> | <i>Data Type</i> | <i>Units</i> |
|                     |   |                        | 0                    | Roll               | Float            | Radians      |
|                     |   |                        | 4                    | Pitch              | Float            | Radians      |
| 8                   | Yaw   | Float                  | Radians              |                    |                  |              |



## 5.1.10 CF Stabilized North Vector (0x80, 0x10)

|                     |  |                        |                      |                    |                  |              |
|---------------------|--|------------------------|----------------------|--------------------|------------------|--------------|
| <b>Description</b>  | Gyro stabilized estimated vector for geomagnetic vector.<br><i>This value is produced by the Complementary Filter fusion algorithm.</i>  |                        |                      |                    |                  |              |
| <b>Notes</b>        | This is a vector which represents the complementary filter's best estimate of the geomagnetic field direction (magnetic north). In the absence of magnetic interference, it should be equal to <i>Magnetometer</i> . When transient magnetic interference is present, <i>Magnetometer</i> will be subject to transient (possibly large) errors. The IMU/AHRS complementary filter computes <i>Stabilized North</i> which is its estimate of the geomagnetic field vector only, even though the system may be exposed to transient magnetic interference. Note that sustained magnetic interference cannot be adequately compensated for by the complementary filter. |                        |                      |                    |                  |              |
| <b>Field Format</b> | <i>Field Length</i>  | <i>Data Descriptor</i> | <i>Message Data</i>  |                    |                  |              |
|                     | 14 (0x0E)  | 0x10                   | <i>Binary Offset</i> | <i>Description</i> | <i>Data Type</i> | <i>Units</i> |
|                     |  |                        | 0                    | X Stab Mag         | Float            | Gauss        |
|                     |  |                        | 4                    | Y Stab Mag         | Float            | Gauss        |
|                     |  | 8                      | Z Stab Mag           | Float              | Gauss            |              |

### 5.1.11 CF Stabilized Up Vector (0x80, 0x11)

|                     |   |                        |                      |                    |                  |              |
|---------------------|---|------------------------|----------------------|--------------------|------------------|--------------|
| <b>Description</b>  | Gyro stabilized estimated vector for the gravity vector.<br><i>This value is produced by the Complementary Filter fusion algorithm.</i>   |                        |                      |                    |                  |              |
| <b>Notes</b>        | This is a vector which represents the IMU/AHRS complementary filter's best estimate of the vertical direction. Under stationary conditions, it should be equal to Accel. In dynamic conditions, Accel will be sensitive to both gravitational acceleration as well as linear acceleration. The Complementary filter computes Stab Accel which is its estimate of the gravitation acceleration only, even though the system may be exposed to significant linear acceleration. |                        |                      |                    |                  |              |
| <b>Field Format</b> | <i>Field Length</i>   | <i>Data Descriptor</i> | <i>Message Data</i>  |                    |                  |              |
|                     | 14 (0x0E)   | 0x11                   | <i>Binary Offset</i> | <i>Description</i> | <i>Data Type</i> | <i>Units</i> |
|                     |   |                        | 0                    | X Stab Accel       | Float            | G            |
|                     |   |                        | 4                    | Y Stab Accel       | Float            | G            |
|                     |   |                        | 8                    | Z Stab Accel       | Float            | G            |

### 5.1.12 GPS Correlation Timestamp (0x80, 0x12)

|                    |   |
|--------------------|---|
| <b>Description</b> | GPS correlation timestamp.  |
| <b>Notes</b>       | <p>This timestamp has three fields:</p> <ul style="list-style-type: none"> <li>Double GPS TOW</li> <li>U16 GPS Week number</li> <li>U16 Timestamp flags</li> </ul> <p>Timestamp Status Flags:</p> <ul style="list-style-type: none"> <li>Bit0 - PPS Beacon Good If set, GNSS PPS signal is present</li> <li>Bit1 - GPS Time Refresh (toggles with each refresh)</li> <li>Bit2 - GPS Time Initialized (set with the first GPS Time Refresh) (<a href="#">See GPS Time Update (0x01, 0x72) on page 41</a>)</li> </ul> <p>This timestamp correlates the IMU packets with the GPS packets. It is identical to the GPS Time record except the flags are defined specifically for the IMU. When the GPS Time Initialized flag is asserted, the GPS Time and IMU GPS Timestamp are</p> |

## 5.1.12 GPS Correlation Timestamp (0x80, 0x12)

The “PPS Beacon Good” flag in the Timestamp flags byte indicates if the PPS beacon coming from the GPS is present. If this flag is not asserted, it means that the IMU internal clock is being used for the PPS. The fractional portion of the GPS TOW represents the amount of time that has elapsed from the last PPS.

If the GPS loses signal, the GPS and IMU timestamps become free running and will slowly drift away from each other. If the timestamp clocks have drifted apart, then there will be a jump in the timestamp when the PPS Beacon Good reasserts, reflecting the amount of drift of the clocks.

See the [Data Synchronicity](#) section of this manual for more information on timestamps.



*It is important to understand that new GNSS constellations such as GLONASS and BeiDou do not use the GPS Time base (the time base of the U.S. GPS constellation). However, their time bases get converted to the GPS Time base by the receiver. The “PPS Beacon Good” flag in the Timestamp flags byte indicates if the PPS beacon coming from the GPS is present. If this flag is not asserted, it means that the IMU internal clock is being used for the PPS. The fractional portion of the GPS TOW represents the amount of time that has elapsed from the last PPS.*

If the GPS loses signal, the GPS and IMU timestamps become free running and will slowly drift away from each other. If the timestamp clocks have drifted apart, then there will be a jump in the timestamp when the PPS Beacon Good reasserts, reflecting the amount of drift of the clocks.

See the [Data Synchronicity](#) section of this manual for more information on timestamps.



*It is important to understand that new GNSS constellations such as GLONASS and BeiDou do not use the GPS Time base (the time base of the U.S. GPS constellation). However, their time bases get converted to the GPS Time base by the receiver.*

| Field Format | Field Length | Data Descriptor | Message Data  |                  |           |         |
|--------------|--------------|-----------------|---------------|------------------|-----------|---------|
|              | 14 (0x0E)    | 0x12            | Binary Offset | Description      | Data Type | Units   |
|              |              |                 | 0             | GPS Time of Week | Double    | Seconds |

## 5.1.12 GPS Correlation Timestamp (0x80, 0x12)

|  |  |  |    |                 |     |           |
|--|--|--|----|-----------------|-----|-----------|
|  |  |  | 8  | GPS Week Number | U16 | N/A       |
|  |  |  | 10 | Timestamp Flags | U16 | See Notes |

## 5.2 GNSS Data

## 5.2.1 LLH Position (0x81, 0x03)

| 5.2.1 LLH Position (0x81, 0x03) |  |                        |                      |                        |                  |                 |
|---------------------------------|--|------------------------|----------------------|------------------------|------------------|-----------------|
| <b>Description</b>              | Position Data in the Geodetic Frame.   |                        |                      |                        |                  |                 |
| <b>Notes</b>                    | Valid Flag Mapping:<br><br>0x0001 - Latitude & Longitude Valid<br>0x0002 - Ellipsoid Height Valid<br>0x0004 - MSL Height Valid<br>0x0008 - Horizontal Accuracy Valid<br>0x0010 - Vertical Accuracy Valid |                        |                      |                        |                  |                 |
| <b>Field Format</b>             | <i>Field Length</i>  | <i>Data Descriptor</i> | <i>Message Data</i>  |                        |                  |                 |
|                                 | 44 (0x2C)  | 0x03                   | <i>Binary Offset</i> | <i>Description</i>     | <i>Data Type</i> | <i>Units</i>    |
|                                 |  |                        | 0                    | Latitude               | Double           | Decimal Degrees |
|                                 |  |                        | 8                    | Longitude              | Double           | Decimal Degrees |
|                                 |  |                        | 16                   | Height above Ellipsoid | Double           | Meters          |
|                                 |  |                        | 24                   | Height above MSL       | Double           | Meters          |
|                                 |  |                        | 32                   | Horizontal Accuracy    | Float            | Meters          |
|                                 |  |                        | 36                   | Vertical Accuracy      | Float            | Meters          |
|                                 |  |                        | 40                   | Valid Flags            | U16              | See Notes       |

## 5.2.2 ECEF Position (0x81, 0x04)

| 5.2.2 ECEF Position (0x81, 0x04) |   |                 |               |                   |           |           |
|----------------------------------|---|-----------------|---------------|-------------------|-----------|-----------|
| Description                      | Position Data in the Earth-Centered, Earth-Fixed Frame.                                 |                 |               |                   |           |           |
| Notes                            | Valid Flag Mapping:<br>0x0001 - ECEF Position Valid<br>0x0002 - Position Accuracy Valid |                 |               |                   |           |           |
| Field Format                     | Field Length  | Data Descriptor | Message Data  |                   |           |           |
|                                  | 32 (0x20)   | 0x04            | Binary Offset | Description       | Data Type | Units     |
|                                  |   |                 | 0             | X Position        | Double    | Meters    |
|                                  |   |                 | 8             | Y Position        | Double    | Meters    |
|                                  |   |                 | 16            | Z Position        | Double    | Meters    |
|                                  |   |                 | 24            | Position Accuracy | Float     | Meters    |
|                                  |   |                 | 28            | Valid Flags       | U16       | See Notes |

## 5.2.3 NED Velocity (0x81, 0x05)

| 5.2.3 NED Velocity (0x81, 0x05) |   |                 |               |                  |           |                 |
|---------------------------------|---|-----------------|---------------|------------------|-----------|-----------------|
| Description                     | Velocity Data in the North-East-Down Frame.   |                 |               |                  |           |                 |
| Notes                           | Valid Flag Mapping:<br>0x0001 - NED Velocity Valid<br>0x0002 - Speed Valid<br>0x0004 - Ground Speed Valid<br>0x0008 - Heading Valid<br>0x0010 - Speed Accuracy Valid<br>0x0020 - Heading Accuracy Valid |                 |               |                  |           |                 |
| Field Format                    | Field Length  | Data Descriptor | Message Data  |                  |           |                 |
|                                 | 36 (0x24)   | 0x05            | Binary Offset | Description      | Data Type | Units           |
|                                 |   |                 | 0             | North            | Float     | Meters/Sec      |
|                                 |   |                 | 4             | East             | Float     | Meters/Sec      |
|                                 |   |                 | 8             | Down             | Float     | Meters/Sec      |
|                                 |   |                 | 12            | Speed            | Float     | Meters/Sec      |
|                                 |   |                 | 16            | Ground Speed     | Float     | Meters/Sec      |
|                                 |   |                 | 20            | Heading          | Float     | Decimal Degrees |
|                                 |   |                 | 24            | Speed Accuracy   | Float     | Meters/Sec      |
|                                 |   |                 | 28            | Heading Accuracy | Float     | Decimal Degrees |
| 32                              |   |                 | Valid Flags   | U16              | See Notes |                 |

## 5.2.4 ECEF Velocity (0x81, 0x06)

| 5.2.4 ECEF Velocity (0x81, 0x06) |   |                        |                      |                    |                  |              |
|----------------------------------|---|------------------------|----------------------|--------------------|------------------|--------------|
| <b>Description</b>               | Velocity Data in the Earth-Centered, Earth-Fixed Frame.                                 |                        |                      |                    |                  |              |
| <b>Notes</b>                     | Valid Flag Mapping:<br>0x0001 - ECEF Velocity Valid<br>0x0002 - Velocity Accuracy Valid |                        |                      |                    |                  |              |
| <b>Field Format</b>              | <i>Field Length</i>   | <i>Data Descriptor</i> | <i>Message Data</i>  |                    |                  |              |
|                                  | 20 (0x14)   | 0x06                   | <i>Binary Offset</i> | <i>Description</i> | <i>Data Type</i> | <i>Units</i> |
|                                  |   |                        | 0                    | X Velocity         | Float            | Meters/Sec   |
|                                  |   |                        | 4                    | Y Velocity         | Float            | Meters/Sec   |
|                                  |   |                        | 8                    | Z Velocity         | Float            | Meters/Sec   |
|                                  |   |                        | 12                   | Velocity Accuracy  | Float            | Meters/Sec   |
|                                  |   |                        | 16                   | Valid Flags        | U16              | See Notes    |



## 5.2.5 DOP Data (0x81, 0x07)

| 5.2.5 DOP Data (0x81, 0x07) |  |                 |               |                |           |       |
|-----------------------------|--|-----------------|---------------|----------------|-----------|-------|
| Description                 | Dilution of Precision Data.  |                 |               |                |           |       |
| Notes                       | Valid Flag Mapping:<br>0x0001 - GDOP Valid<br>0x0002 - PDOP Valid<br>0x0004 - HDOP Valid<br>0x0008 - VDOP Valid<br>0x0010 - TDOP Valid<br>0x0020 - NDOP Valid<br>0x0040 - EDOP Valid |                 |               |                |           |       |
| Field Format                | Field Length   | Data Descriptor | Message Data  |                |           |       |
|                             | 32 (0x20)  | 0x07            | Binary Offset | Description    | Data Type | Units |
|                             |  |                 | 0             | Geometric DOP  | Float     | N/A   |
|                             |  |                 | 4             | Position DOP   | Float     | N/A   |
|                             |  |                 | 8             | Horizontal DOP | Float     | N/A   |
|                             |  |                 | 12            | Vertical DOP   | Float     | N/A   |
|                             |  |                 | 16            | Time DOP       | Float     | N/A   |
|                             |  |                 | 20            | Northing DOP   | Float     | N/A   |
|                             |  |                 | 24            | Easting DOP    | Float     | N/A   |
| 28                          | Valid Flags  | U16             | See Notes     |                |           |       |

## 5.2.6 UTC Time (0x81, 0x08)

| 5.2.6 UTC Time (0x81, 0x08) |   |                        |                      |                    |                  |                   |
|-----------------------------|---|------------------------|----------------------|--------------------|------------------|-------------------|
| Description                 | Coordinated Universal Time Data                                   |                        |                      |                    |                  |                   |
| Notes                       | Valid Flag Mapping:<br>0x0001 - Date Valid<br>0x0002 - Time Valid |                        |                      |                    |                  |                   |
| Field Format                | <i>Field Length</i>   | <i>Data Descriptor</i> | <i>Message Data</i>  |                    |                  |                   |
|                             | 15 (0x0F)   | 0x08                   | <i>Binary Offset</i> | <i>Description</i> | <i>Data Type</i> | <i>Units</i>      |
|                             |   |                        | 0                    | Year               | U16              | Years (1999-2099) |
|                             |   |                        | 2                    | Month              | U8               | Months (1-12)     |
|                             |   |                        | 3                    | Day                | U8               | Days (1-31)       |
|                             |   |                        | 4                    | Hour               | U8               | Hours (0-23)      |
|                             |   |                        | 5                    | Minute             | U8               | Minutes (0-59)    |
|                             |   |                        | 6                    | Second             | U8               | Seconds (0-59)    |
|                             |   |                        | 7                    | Millisecond        | U32              | Milliseconds      |
|                             |   |                        | 11                   | Valid Flags        | U16              | See Notes         |

### 5.2.7 GPS Time (0x81, 0x09)

|                     |   |                        |                      |                    |                  |              |
|---------------------|---|------------------------|----------------------|--------------------|------------------|--------------|
| <b>Description</b>  | Global Positioning System Time Data                                     |                        |                      |                    |                  |              |
| <b>Notes</b>        | Valid Flag Mapping:<br>0x0001 - TOW Valid<br>0x0002 - Week Number Valid |                        |                      |                    |                  |              |
| <b>Field Format</b> | <i>Field Length</i>   | <i>Data Descriptor</i> | <i>Message Data</i>  |                    |                  |              |
|                     | 14 (0x0E)   | 0x09                   | <i>Binary Offset</i> | <i>Description</i> | <i>Data Type</i> | <i>Units</i> |
|                     |   |                        | 0                    | Time of Week       | Double           | Seconds      |
|                     |   |                        | 8                    | Week Number        | U16              | N/A          |
|                     |   |                        | 10                   | Valid Flags        | U16              | See Notes    |

### 5.2.8 Clock Information (0x81, 0x0A)

|                     |  |                        |                      |                    |                  |                |
|---------------------|--|------------------------|----------------------|--------------------|------------------|----------------|
| <b>Description</b>  | Detailed information about the GNSS Clock.   |                        |                      |                    |                  |                |
| <b>Notes</b>        | Valid Flag Mapping:<br>0x0001 - Bias Valid<br>0x0002 - Drift Valid<br>0x0004 - Accuracy Estimate Valid |                        |                      |                    |                  |                |
| <b>Field Format</b> | <i>Field Length</i>  | <i>Data Descriptor</i> | <i>Message Data</i>  |                    |                  |                |
|                     | 28 (0x1C)  | 0x0A                   | <i>Binary Offset</i> | <i>Description</i> | <i>Data Type</i> | <i>Units</i>   |
|                     |  |                        | 0                    | Clock Bias         | Double           | Seconds        |
|                     |  |                        | 8                    | Clock Drift        | Double           | Seconds/Second |
|                     |  |                        | 16                   | Accuracy Estimate  | Double           | Seconds        |
| 24                  | Valid Flags  | U16                    | See Notes            |                    |                  |                |

## 5.2.9 GNSS Fix Information (0x81, 0x0B)

| Description  | Current GNSS Fix Status Information   |                        |                      |                                 |                  |              |
|--------------|---|------------------------|----------------------|---------------------------------|------------------|--------------|
| Notes        | <p>Valid Flag Mapping:</p> <p>0x0001 - Fix Type Valid<br/> 0x0002 - Number of SVs Valid<br/> 0x0004 - Fix Flags Valid</p> <p>Possible Fix Types values are:</p> <p>0x00 - 3D Fix<br/> 0x01 - 2D Fix<br/> 0x02 - Time Only<br/> 0x03 - None<br/> 0x04 - Invalid</p> <p>Possible Fix Flags are:</p> <p>0x0001 - SBAS Corrections Used<br/> 0x0002 - Differential (DGNSS) Corrections Used</p> |                        |                      |                                 |                  |              |
| Field Format | <i>Field Length</i>   | <i>Data Descriptor</i> | <i>Message Data</i>  |                                 |                  |              |
|              | 8 (0x08)  | 0x0B                   | <i>Binary Offset</i> | <i>Description</i>              | <i>Data Type</i> | <i>Units</i> |
|              |   |                        | 0                    | Fix Type                        | U8               | See Notes    |
|              |   |                        | 1                    | Number of SVs used for solution | U8               | Count        |
|              |   |                        | 2                    | Fix Flags (Reserved)            | U16              | N/A          |
| 4            | Valid Flags   | U16                    | See Notes            |                                 |                  |              |

## 5.2.10 Space Vehicle Information (0x81, 0x0C)

| 5.2.10 Space Vehicle Information (0x81, 0x0C) |   |                        |                      |                        |                  |                 |
|---|---|------------------------|----------------------|------------------------|------------------|-----------------|
| Description                                   | Individual Space Vehicle Information Entry  |                        |                      |                        |                  |                 |
| Notes   | When enabled, these fields will arrive in a separate MIP packet.  |                        |                      |                        |                  |                 |
|   | Valid Flag Mapping:<br>0x0001 - Channel Valid<br>0x0002 - SV ID Valid<br>0x0008 - Carrier to Noise Ratio Valid<br>0x0010 - Azimuth Valid<br>0x0020 - Elevation Valid<br>0x0040 - SV Flags Valid<br><br>SV Flag Mapping:<br>0x0001 - SV Used for Navigation<br>0x0002 - SV Healthy |                        |                      |                        |                  |                 |
| Field Format                                  | <i>Field Length</i>   | <i>Data Descriptor</i> | <i>Message Data</i>  |                        |                  |                 |
|   | 14 (0x0E)   | 0x0C                   | <i>Binary Offset</i> | <i>Description</i>     | <i>Data Type</i> | <i>Units</i>    |
|   |   |                        | 0                    | Channel                | U8               | Channel Number  |
|   |   |                        | 1                    | Space Vehicle ID       | U8               | SV ID Number    |
|   |   |                        | 2                    | Carrier to Noise Ratio | U16              | dBHz            |
|   |   |                        | 4                    | Azimuth                | S16              | Integer Degrees |
|   |   |                        | 6                    | Elevation              | S16              | Integer Degrees |
|   |   |                        | 8                    | Space Vehicle Flags    | U16              | See Notes       |
|   |   |                        | 10                   | Valid Flags            | U16              | See Notes       |

## 5.2.11 Hardware Status (0x81, 0x0D)

| Description | GNSS Hardware Status Information   |                     |                        |                     |                  |              |
|-------------|--|---------------------|------------------------|---------------------|------------------|--------------|
| Notes       | <p>Hardware status is only available at 1 Hz. Setting the rate higher than 1 Hz has no effect.</p> <p>Valid Flag Mapping:</p> <p style="padding-left: 40px;">0x0001 - Sensor State Valid<br/>0x0002 - Antenna State Valid<br/>0x0004 - Antenna Power Valid</p> <p>Possible Sensor State values:</p> <p style="padding-left: 40px;">0x00 - Sensor Off<br/>0x01 - Sensor On<br/>0x02 - Sensor State Unknown</p> <p>Possible Antenna State values:</p> <p style="padding-left: 40px;">0x01 - Antenna Init<br/>0x02 - Antenna Short<br/>0x03 - Antenna Open<br/>0x04 - Antenna Good<br/>0x05 - Antenna State Unknown.</p> <p>Possible Antenna Power values:</p> <p style="padding-left: 40px;">0x00 - Antenna Off<br/>0x01 - Antenna On<br/>0x02 - Antenna Power Unknown</p> |                     |                        |                     |                  |              |
|             | Field Format   | <i>Field Length</i> | <i>Data Descriptor</i> | <i>Message Data</i> |                  |              |
| 7 (0x07)    |  | 0x0D                | <i>Binary Offset</i>   | <i>Description</i>  | <i>Data Type</i> | <i>Units</i> |
|             |  |                     | 0                      | Sensor State        | U8               | See Notes    |
|             |  |                     | 1                      | Antenna State       | U8               | See Notes    |
|             |  |                     | 2                      | Antenna Power       | U8               | See Notes    |
| 3           | Valid Flags  | U16                 | See Notes              |                     |                  |              |

## 5.2.12 DGNSS Information (0x81, 0x0E)

| Description         | Individual DGNSS Channel Status Entry  |                        |                      |                          |                  |              |
|---------------------|--|------------------------|----------------------|--------------------------|------------------|--------------|
| <b>Notes</b>        | <p>When enabled, a separate field for each active space vehicle will be sent in the packet.</p> <p>Valid Flag Mapping:</p> <ul style="list-style-type: none"> <li>0x0001 - Latest Age Valid</li> <li>0x0002 - Base Station ID Valid</li> <li>0x0004 - Base Station Status Valid</li> <li>0x0008 - Number of DGNSS Channels Valid</li> </ul> <p>Possible Base Station Status Values:</p> <ul style="list-style-type: none"> <li>0 - UDRE Scale Factor = 1.0</li> <li>1 - UDRE Scale Factor = 0.75</li> <li>2 - UDRE Scale Factor = 0.5</li> <li>3 - UDRE Scale Factor = 0.3</li> <li>4 - UDRE Scale Factor = 0.2</li> <li>5 - UDRE Scale Factor = 0.1</li> <li>6 - Reference Station Transmission Not Monitored</li> <li>7 - Reference Station Not Working</li> </ul> <p>Note: UDRE = User Differential Range Error</p> |                        |                      |                          |                  |              |
| <b>Field Format</b> | <i>Field Length</i>  | <i>Data Descriptor</i> | <i>Message Data</i>  |                          |                  |              |
|                     | 14 (0x0E)  | 0x0E                   | <i>Binary Offset</i> | <i>Description</i>       | <i>Data Type</i> | <i>Units</i> |
|                     |  |                        | 0                    | Newest Age               | Float            | Seconds      |
|                     |  |                        | 4                    | Base Station ID          | S16              | N/A          |
|                     |  |                        | 6                    | Base Station Status      | S16              | N/A          |
|                     |  |                        | 8                    | Number of DGNSS Channels | U16              | Number       |
| 10                  | Valid Flags  | U16                    | See Notes            |                          |                  |              |

## 5.2.13 DGNSS Channel Status (0x81, 0x0F)

| 5.2.13 DGNSS Channel Status (0x81, 0x0F) |   |                        |                      |                             |                  |              |
|--|---|------------------------|----------------------|-----------------------------|------------------|--------------|
| <b>Description</b>                       | Individual DGNSS Channel Status Entry   |                        |                      |                             |                  |              |
| <b>Notes</b>                             | <p>When enabled, a separate field for each active space vehicle will be sent in the packet.</p> <p>Valid Flag Mapping:</p> <p>0x0001 - SV ID Valid<br/> 0x0002 - Age Valid<br/> 0x0004 - Pseudorange Correction Valid<br/> 0x0008 - Pseudorange Rate Correction Valid</p> |                        |                      |                             |                  |              |
| <b>Field Format</b>                      | <i>Field Length</i>   | <i>Data Descriptor</i> | <i>Message Data</i>  |                             |                  |              |
|  | 17 (0x11)   | 0x0F                   | <i>Binary Offset</i> | <i>Description</i>          | <i>Data Type</i> | <i>Units</i> |
|  |   |                        | 0                    | Space Vehicle ID            | U8               | SV ID Number |
|  |   |                        | 1                    | Age                         | Float            | Seconds      |
|  |   |                        | 5                    | Pseudorange Correction      | Float            | Meters       |
|  |   |                        | 9                    | Pseudorange Rate Correction | Float            | Meters/Sec   |
| 13                                       | Valid Flags   | U16                    | See Notes            |                             |                  |              |



## 5.3 Estimation Filter Data

### 5.3.1 Filter Status (0x82, 0x10)

| Description | Estimation Filter Status   |
|-------------|--|
| Notes       | <p>Possible Filter States:</p> <ul style="list-style-type: none"> <li>0x00 - Startup</li> <li>0x01 - Initialization (see status flags)</li> <li>0x02 - Running, Solution Valid</li> <li>0x03 - Running, Solution Error (see status flags)</li> </ul> <p>Possible Dynamics Modes:</p> <ul style="list-style-type: none"> <li>0x01 - Portable</li> <li>0x02 - Automotive</li> <li>0x03 - Airborne</li> </ul> <p>Possible Status Flags:</p> <p>Filter State = Initialization:</p> <ul style="list-style-type: none"> <li>0x1000 - Attitude not initialized</li> <li>0x2000 - Position &amp; Velocity not initialized</li> </ul> <p>Filter State = Running:</p> <ul style="list-style-type: none"> <li>0x0001 - IMU unavailable</li> <li>0x0002 - GNSS (GNSS versions only)</li> <li>0x0008 - Matrix singularity in calculation</li> <li>0x0010 - Position covariance high warning*</li> <li>0x0020 - Velocity covariance high warning*</li> <li>0x0040 - Attitude covariance high warning*</li> <li>0x0080 - NAN in solution</li> <li>0x0100 - Gyro bias estimate high warning</li> <li>0x0200 - Accel bias estimate high warning</li> <li>0x0400 - Gyro scale factor estimate high warning</li> <li>0x0800 - Accel scale factor estimate high warning</li> <li>0x1000 - Mag bias estimate high warning</li> <li>0x2000 - GNSS antenna offset correction estimate high warning</li> <li>0x4000 - Hard Iron offset estimate high warning</li> <li>0x8000 - Soft iron correction estimate high warning</li> </ul> |

### 5.3.1 Filter Status (0x82, 0x10)

*\* Note: The covariance high warnings are triggered when any axis of the covariance vector exceeds normal operating limits. If more information is required, please inspect the relevant uncertainty packet to determine which axis is in error.*

| Field Format | Field Length | Data Descriptor | Message Data  |               |           |           |
|--------------|--------------|-----------------|---------------|---------------|-----------|-----------|
|              | 08 (0x08)    | 0x10            | Binary Offset | Description   | Data Type | Units     |
|              |              |                 | 0             | Filter State  | U16       | See Notes |
|              |              |                 | 2             | Dynamics Mode | U16       | See Notes |
|              |              |                 | 4             | Status Flags  | U16       | See Notes |

## 5.3.2 GPS Timestamp (0x82, 0x11)

| 5.3.2 GPS Timestamp (0x82, 0x11) |   |                        |                      |                    |                  |              |
|----------------------------------|---|------------------------|----------------------|--------------------|------------------|--------------|
| <b>Description</b>               | Estimation Filter Calculated Value Timestamp Data                   |                        |                      |                    |                  |              |
| <b>Notes</b>                     | Valid Flag Mapping:<br>0x0000 - Time Invalid<br>0x0001 - Time Valid |                        |                      |                    |                  |              |
| <b>Field Format</b>              | <i>Field Length</i>   | <i>Data Descriptor</i> | <i>Message Data</i>  |                    |                  |              |
|                                  | 14 (0x0E)   | 0x11                   | <i>Binary Offset</i> | <i>Description</i> | <i>Data Type</i> | <i>Units</i> |
|                                  |   |                        | 0                    | Time of Week       | Double           | Seconds      |
|                                  |   |                        | 8                    | Week Number        | U16              | N/A          |
|                                  |   |                        | 10                   | Valid Flags        | U16              | See Notes    |

### 5.3.3 LLH Position (0x82, 0x01)

| Description  | Estimated Position Data expressed in the Geodetic Frame   |                        |                      |                        |                  |                 |
|--------------|---|------------------------|----------------------|------------------------|------------------|-----------------|
| Notes        | Valid Flag Mapping:<br>0x0000 - Latitude, Longitude, & Height are Invalid<br>0x0001 - Latitude, Longitude, & Height Valid |                        |                      |                        |                  |                 |
| Field Format | <i>Field Length</i>   | <i>Data Descriptor</i> | <i>Message Data</i>  |                        |                  |                 |
|              | 28 (0x1C)   | 0x01                   | <i>Binary Offset</i> | <i>Description</i>     | <i>Data Type</i> | <i>Units</i>    |
|              |   |                        | 0                    | Latitude               | Double           | Decimal Degrees |
|              |   |                        | 8                    | Longitude              | Double           | Decimal Degrees |
|              |   |                        | 16                   | Height above Ellipsoid | Double           | Meters          |
| 24           | Valid Flags   | U16                    | See Notes            |                        |                  |                 |

### 5.3.4 LLH Position Uncertainty (0x82, 0x08)

|                     |   |                        |                      |   |                  |              |
|---------------------|---|------------------------|----------------------|---|------------------|--------------|
| <b>Description</b>  | Estimated Position 1-sigma Uncertainty expressed in the Geodetic Frame                                      |                        |                      |   |                  |              |
| <b>Notes</b>        | Valid Flag Mapping:<br>0x0000 - Position Uncertainties are Invalid<br>0x0001 - Position Uncertainties Valid |                        |                      |   |                  |              |
| <b>Field Format</b> | <i>Field Length</i>   | <i>Data Descriptor</i> | <i>Message Data</i>  |   |                  |              |
|                     | 16 (0x10)   | 0x08                   | <i>Binary Offset</i> | <i>Description</i>                                | <i>Data Type</i> | <i>Units</i> |
|                     |   |                        | 0                    | Local-Level, 1-Sigma Position Uncertainty (North) | Float            | Meters       |
|                     |   |                        | 4                    | Local-Level, 1-Sigma Position Uncertainty (East)  | Float            | Meters       |
|                     |   |                        | 8                    | Local-Level, 1-Sigma Position Uncertainty (Down)  | Float            | Meters       |
| 12                  | Valid Flags   | U16                    | See Notes            |   |                  |              |

### 5.3.5 NED Velocity (0x82, 0x02)

|                     |  |                        |                      |                    |                  |              |
|---------------------|--|------------------------|----------------------|--------------------|------------------|--------------|
| <b>Description</b>  | Estimated Velocity Data expressed in the Local-Level Frame                             |                        |                      |                    |                  |              |
| <b>Notes</b>        | Valid Flag Mapping:<br>0x0000 - NED Velocity is Invalid<br>0x0001 - NED Velocity Valid |                        |                      |                    |                  |              |
| <b>Field Format</b> | <i>Field Length</i>  | <i>Data Descriptor</i> | <i>Message Data</i>  |                    |                  |              |
|                     | 16 (0x10)  | 0x02                   | <i>Binary Offset</i> | <i>Description</i> | <i>Data Type</i> | <i>Units</i> |
|                     |  |                        | 0                    | North              | Float            | Meters/Sec   |
|                     |  |                        | 4                    | East               | Float            | Meters/Sec   |
|                     |  |                        | 8                    | Down               | Float            | Meters/Sec   |
| 12                  | Valid Flags  | U16                    | See Notes            |                    |                  |              |

## 5.3.6 NED Velocity Uncertainty (0x82, 0x09)

| 5.3.6 NED Velocity Uncertainty (0x82, 0x09) |   |                 |               |   |           |            |
|---|---|-----------------|---------------|---|-----------|------------|
| Description                                 | Estimated Velocity 1-sigma Uncertainty expressed in the Local-Level Frame   |                 |               |   |           |            |
| Notes                                       | Valid Flag Mapping:<br>0x0000 - NED Velocity Uncertainties are Invalid<br>0x0001 - NED Velocity Uncertainties Valid |                 |               |   |           |            |
| Field Format                                | Field Length  | Data Descriptor | Message Data  |   |           |            |
|   | 16 (0x10)   | 0x09            | Binary Offset | Description                                       | Data Type | Units      |
|   |   |                 | 0             | Local-Level, 1-Sigma Velocity Uncertainty (North) | Float     | Meters/Sec |
|   |   |                 | 4             | Local-Level, 1-Sigma Velocity Uncertainty (East)  | Float     | Meters/Sec |
|   |   |                 | 8             | Local-Level, 1-Sigma Velocity Uncertainty (Down)  | Float     | Meters/Sec |
| 12  | Valid Flags   | U16             | N/A           |   |           |            |

## 5.3.7 Orientation, Quaternion (0x82, 0x03)

| Description  | Estimated Orientation in quaternion form.   |                        |                      |                    |                  |              |
|--------------|---|------------------------|----------------------|--------------------|------------------|--------------|
| Notes        | This is a four component quaternion which describes the orientation of the 3DM-GX5 with respect to the fixed earth coordinate system.   |                        |                      |                    |                  |              |
|              | $Q = \begin{bmatrix} q_0 \\ q_1 \\ q_2 \\ q_3 \end{bmatrix}$ <p>Q satisfies the following equation:</p> $V\_IL_i = Q \cdot V\_E \cdot Q^{-1}$ <p>Where:</p> <p><i>V_IL</i> is a vector expressed in the 3DM- GX5's local coordinate system.</p> <p><i>V_E</i> is the same vector expressed in the stationary, earth- fixed coordinate system</p> <p>Valid Flag Mapping:</p> <p>0x0000 - Quaternion is Invalid<br/>0x0001 - Quaternion Valid</p> |                        |                      |                    |                  |              |
| Field Format | <i>Field Length</i>   | <i>Data Descriptor</i> | <i>Message Data</i>  |                    |                  |              |
|              | 20 (0x14)   | 0x03                   | <i>Binary Offset</i> | <i>Description</i> | <i>Data Type</i> | <i>Units</i> |
|              |   |                        | 0                    | q <sub>0</sub>     | Float            | N/A          |
|              |   |                        | 4                    | q <sub>1</sub> *i  | Float            | N/A          |
|              |   |                        | 8                    | q <sub>2</sub> *j  | Float            | N/A          |
|              |   |                        | 12                   | q <sub>3</sub> *k  | Float            | N/A          |
| 16           | Valid Flags   | U16                    | See Notes            |                    |                  |              |

## 5.3.8 Attitude Uncertainty, Quaternion Elements (0x82, 0x12)

|                     |  |                        |                      |  |                  |              |
|---------------------|--|------------------------|----------------------|--|------------------|--------------|
| <b>Description</b>  | Estimated attitude 1-sigma uncertainty expressed in quaternion components.   |                        |                      |  |                  |              |
| <b>Notes</b>        | <p>This is a three component vector containing the attitude uncertainty expressed in quaternion elements.</p> <p>Valid Flag Mapping:</p> <p>0x0000 - Attitude uncertainties are Invalid</p> <p>0x0001 - Attitude uncertainties are Valid</p> |                        |                      |  |                  |              |
| <b>Field Format</b> | <i>Field Length</i>  | <i>Data Descriptor</i> | <i>Message Data</i>  |  |                  |              |
|                     | 20 (0x14)  | 0x12                   | <i>Binary Offset</i> | <i>Description</i>                             | <i>Data Type</i> | <i>Units</i> |
|                     |  |                        | 0                    | 1-Sigma Attitude Uncertainty (q <sub>0</sub> ) | Float            |              |
|                     |  |                        | 4                    | 1-Sigma Attitude Uncertainty (q <sub>1</sub> ) | Float            |              |
|                     |  |                        | 8                    | 1-Sigma Attitude Uncertainty (q <sub>2</sub> ) | Float            |              |
|                     |  |                        | 12                   | 1-Sigma Attitude Uncertainty (q <sub>3</sub> ) | Float            |              |
| 16                  | Valid Flags  | U16                    | See Notes            |  |                  |              |



## 5.3.9 Orientation, Euler Angles (0x82, 0x05)

| 5.3.9 Orientation, Euler Angles (0x82, 0x05) |  |                        |                      |                    |                  |              |
|--|--|------------------------|----------------------|--------------------|------------------|--------------|
| <b>Description</b>                           | Estimated Pitch, Roll, and Yaw (aircraft) values.  |                        |                      |                    |                  |              |
| <b>Notes</b>                                 | <p>This is a three component vector containing the Roll, Pitch and Yaw angles in radians. It is computed by the INS from the orientation quaternion <math>Q</math>.</p> $Euler = \begin{bmatrix} Roll \\ Pitch \\ Yaw \end{bmatrix}$ <p>Valid Flag Mapping:</p> <p>0x0000 - Euler Angles are Invalid<br/>0x0001 - Euler Angles Valid</p> |                        |                      |                    |                  |              |
| <b>Field Format</b>                          | <i>Field Length</i>  | <i>Data Descriptor</i> | <i>Message Data</i>  |                    |                  |              |
|  |  |                        | <i>Binary Offset</i> | <i>Description</i> | <i>Data Type</i> | <i>Units</i> |
|  | 16 (0x10)  | 0x05                   | 0                    | Roll               | Float            | Radians      |
|  |  |                        | 4                    | Pitch              | Float            | Radians      |
|  |  |                        | 8                    | Yaw                | Float            | Radians      |
| 12   |  |                        | Valid Flags          | U16                | See Notes        |              |

## 5.3.10 Attitude Uncertainty, Euler Angles (0x82, 0x0A)

|                     |   |                        |                      |                                      |                  |              |
|---------------------|---|------------------------|----------------------|--------------------------------------|------------------|--------------|
| <b>Description</b>  | Estimated attitude 1-sigma uncertainty expressed in Pitch, Roll, and Yaw (aircraft) elements.   |                        |                      |                                      |                  |              |
| <b>Notes</b>        | <p>This is a three component vector containing the Roll, Pitch and Yaw angle uncertainties in radians.</p> <p><b>IMPORTANT:</b> These values are derived from the quaternion elements and become increasingly inaccurate as the pitch angle approaches +/-90 degrees. To compensate for this limitation, these values will be marked as invalid when the pitch angle exceeds +/-70 degrees.</p> <p>Valid Flag Mapping:</p> <p style="padding-left: 40px;">0x0000 - Attitude Uncertainties are Invalid<br/>0x0001 - Attitude Uncertainties Valid</p> |                        |                      |                                      |                  |              |
| <b>Field Format</b> | <i>Field Length</i>   | <i>Data Descriptor</i> | <i>Message Data</i>  |                                      |                  |              |
|                     | 16 (0x10)   | 0x0A                   | <i>Binary Offset</i> | <i>Description</i>                   | <i>Data Type</i> | <i>Units</i> |
|                     |   |                        | 0                    | 1-Sigma Attitude Uncertainty (Roll)  | Float            | Radians      |
|                     |   |                        | 4                    | 1-Sigma Attitude Uncertainty (Pitch) | Float            | Radians      |
|                     |   |                        | 8                    | 1-Sigma Attitude Uncertainty (Yaw)   | Float            | Radians      |
| 12                  | Valid Flags   | U16                    | See Notes            |                                      |                  |              |

## 5.3.11 Orientation, Matrix (0x82, 0x04)

| Description  | Estimated orientation in matrix form.  |                 |               |             |           |       |
|--------------|--|-----------------|---------------|-------------|-----------|-------|
| Notes        | <p>This is a nine component coordinate transformation matrix which describes the orientation of the 3DM-GX5 with respect to the fixed earth coordinate system.</p> $M = \begin{bmatrix} M_{1,1} & M_{1,2} & M_{1,3} \\ M_{2,1} & M_{2,2} & M_{2,3} \\ M_{3,1} & M_{3,2} & M_{3,3} \end{bmatrix}$ <p><math>M</math> satisfies the following equation:</p> $V\_IL_i = M_{ij} \cdot V\_E_j$ <p>Where:</p> <p><math>V\_IL</math> is a vector expressed in the 3DM- GX5's local coordinate system.</p> <p><math>V\_E</math> is the same vector expressed in the stationary, earth- fixed coordinate system</p> <p>Valid Flag Mapping:</p> <p>0x0000 - Orientation Matrix is Invalid<br/>0x0001 - Orientation Matrix Valid</p> |                 |               |             |           |       |
| Field Format | Field Length   | Data Descriptor | Message Data  |             |           |       |
|              | 40 (0x28)  | 0x04            | Binary Offset | Description | Data Type | Units |
|              |  |                 | 0             | $M_{1,1}$   | Float     | N/A   |
|              |  |                 | 4             | $M_{1,2}$   | Float     | N/A   |
|              |  |                 | 8             | $M_{1,3}$   | Float     | N/A   |
|              |  |                 | 12            | $M_{2,1}$   | Float     | N/A   |
|              |  |                 | 16            | $M_{2,2}$   | Float     | N/A   |
|              |  |                 | 20            | $M_{2,3}$   | Float     | N/A   |
| 24           |  |                 | $M_{3,1}$     | Float       | N/A       |       |

## 5.3.11 Orientation, Matrix (0x82, 0x04)

|  |  |  |    |                  |       |           |
|--|--|--|----|------------------|-------|-----------|
|  |  |  | 28 | M <sub>3,2</sub> | Float | N/A       |
|  |  |  | 32 | M <sub>3,3</sub> | Float | N/A       |
|  |  |  | 36 | Valid Flags      | U16   | See Notes |

## 5.3.12 Compensated Angular Rate (0x82, 0x0E)

|                     |   |                        |                      |                    |                  |              |
|---------------------|---|------------------------|----------------------|--------------------|------------------|--------------|
| <b>Description</b>  | Filter-Compensated Angular Rate Data expressed in: <ol style="list-style-type: none"> <li>The Sensor Frame, if no sensor to body rotation has been defined.</li> <li>The Vehicle Frame, if a sensor to body rotation has been defined.</li> </ol> |                        |                      |                    |                  |              |
| <b>Notes</b>        | The estimated gyro bias has been removed from these angular rate values.<br>Valid Flag Mapping:<br>0x0000 - Angular Rates are not Valid<br>0x0001 - Angular Rates are Valid   |                        |                      |                    |                  |              |
| <b>Field Format</b> | <i>Field Length</i>   | <i>Data Descriptor</i> | <i>Message Data</i>  |                    |                  |              |
|                     | 16 (0x10)   | 0x0E                   | <i>Binary Offset</i> | <i>Description</i> | <i>Data Type</i> | <i>Units</i> |
|                     |   |                        | 0                    | X                  | Float            | Radians/Sec  |
|                     |   |                        | 4                    | Y                  | Float            | Radians/Sec  |
|                     |   |                        | 8                    | Z                  | Float            | Radians/Sec  |
| 12                  | Valid Flags   | U16                    | See Notes            |                    |                  |              |

## 5.3.13 Gyro Bias (0x82, 0x06)

| 5.3.13 Gyro Bias (0x82, 0x06) |   |                        |                      |                    |                  |              |
|-------------------------------|---|------------------------|----------------------|--------------------|------------------|--------------|
| <b>Description</b>            | Estimated Gyro Biases expressed in the Sensor Body Frame.                         |                        |                      |                    |                  |              |
| <b>Notes</b>                  | Valid Flag Mapping:<br>0x0000 - Gyro Bias are Invalid<br>0x0001 - Gyro Bias Valid |                        |                      |                    |                  |              |
| <b>Field Format</b>           | <i>Field Length</i>   | <i>Data Descriptor</i> | <i>Message Data</i>  |                    |                  |              |
|                               | 16 (0x10)   | 0x06                   | <i>Binary Offset</i> | <i>Description</i> | <i>Data Type</i> | <i>Units</i> |
|                               |   |                        | 0                    | X Gyro Bias        | Float            | Radians/Sec  |
|                               |   |                        | 4                    | Y Gyro Bias        | Float            | Radians/Sec  |
|                               |   |                        | 8                    | Z Gyro Bias        | Float            | Radians/Sec  |
| 12                            | Valid Flags   | U16                    | See Notes            |                    |                  |              |

## 5.3.14 Gyro Bias Uncertainty (0x82, 0x0B)

| 5.3.14 Gyro Bias Uncertainty (0x82, 0x0B) |   |                        |                      |                                   |                  |              |
|---|---|------------------------|----------------------|-----------------------------------|------------------|--------------|
| <b>Description</b>                        | Estimated Gyro Bias 1-sigma Uncertainty expressed in the Sensor Body Frame.                                   |                        |                      |                                   |                  |              |
| <b>Notes</b>                              | Valid Flag Mapping:<br>0x0000 - Gyro Bias Uncertainties are Invalid<br>0x0001 - Gyro Bias Uncertainties Valid |                        |                      |                                   |                  |              |
| <b>Field Format</b>                       | <i>Field Length</i>   | <i>Data Descriptor</i> | <i>Message Data</i>  |                                   |                  |              |
|   | 16 (0x10)   | 0x0B                   | <i>Binary Offset</i> | <i>Description</i>                | <i>Data Type</i> | <i>Units</i> |
|   |   |                        | 0                    | 1-Sigma Gyro Bias Uncertainty (X) | Float            | Radians/Sec  |
|   |   |                        | 4                    | 1-Sigma Gyro Bias Uncertainty (Y) | Float            | Radians/Sec  |
|   |   |                        | 8                    | 1-Sigma Gyro Bias Uncertainty (Z) | Float            | Radians/Sec  |
| 12  | Valid Flags   | U16                    | See Notes            |                                   |                  |              |

## 5.3.15 Gyro Scale Factor (0x82, 0x16)

| 5.3.15 Gyro Scale Factor (0x82, 0x16) |   |                        |                      |                    |                  |              |
|---------------------------------------|---|------------------------|----------------------|--------------------|------------------|--------------|
| <b>Description</b>                    | Estimated Gyro Scale Factor expressed in the Sensor Body Frame.   |                        |                      |                    |                  |              |
| <b>Notes</b>                          | Valid Flag Mapping:<br>0x0000 - Scale Factor values are Invalid<br>0x0001 - Scale Factor values are Valid |                        |                      |                    |                  |              |
| <b>Field Format</b>                   | <i>Field Length</i>   | <i>Data Descriptor</i> | <i>Message Data</i>  |                    |                  |              |
|                                       | 16 (0x10)   | 0x16                   | <i>Binary Offset</i> | <i>Description</i> | <i>Data Type</i> | <i>Units</i> |
|                                       |   |                        | 0                    | X Scale Factor     | Float            | %/100        |
|                                       |   |                        | 4                    | Y Scale Factor     | Float            | %/100        |
|                                       |   |                        | 8                    | Z Scale Factor     | Float            | %/100        |
| 12                                    | Valid Flags   | U16                    | See Notes            |                    |                  |              |

## 5.3.16 Gyro Scale Factor Uncertainty (0x82, 0x18)

| 5.3.16 Gyro Scale Factor Uncertainty (0x82, 0x18) |   |                        |                      |   |                  |              |
|---|---|------------------------|----------------------|---|------------------|--------------|
| <b>Description</b>                                | Estimated Gyro Scale Factor 1-Sigma Uncertainty expressed in the Sensor Body Frame.   |                        |                      |   |                  |              |
| <b>Notes</b>                                      | Valid Flag Mapping:<br>0x0000 - Gyro Scale Factor Uncertainties are Invalid<br>0x0001 - Gyro Scale Factor Uncertainties Valid |                        |                      |   |                  |              |
| <b>Field Format</b>                               | <i>Field Length</i>   | <i>Data Descriptor</i> | <i>Message Data</i>  |   |                  |              |
|   | 16 (0x10)   | 0x18                   | <i>Binary Offset</i> | <i>Description</i>                        | <i>Data Type</i> | <i>Units</i> |
|   |   |                        | 0                    | 1-Sigma Gyro Scale Factor Uncertainty (X) | Float            | %/100        |
|   |   |                        | 4                    | 1-Sigma Gyro Scale Factor Uncertainty (Y) | Float            | %/100        |
|   |   |                        | 8                    | 1-Sigma Gyro Scale Factor Uncertainty (Z) | Float            | %/100        |
| 12  | Valid Flags   | U16                    | See Notes            |   |                  |              |

## 5.3.17 Compensated Acceleration (0x82, 0x1C)

|                     |   |                        |                      |                    |                  |                           |  |
|---------------------|---|------------------------|----------------------|--------------------|------------------|---------------------------|--|
| <b>Description</b>  | Filter-Compensated Acceleration Data expressed in: <ol style="list-style-type: none"> <li>1. The Sensor Frame, if no sensor to body rotation has been defined.</li> <li>2. The Vehicle Frame, if a sensor to body rotation has been defined.</li> </ol> |                        |                      |                    |                  |                           |  |
| <b>Notes</b>        | Valid Flag Mapping:<br>0x0000 - Compensated Accelerations are Invalid<br>0x0001 - Compensated Accelerations are Valid   |                        |                      |                    |                  |                           |  |
| <b>Field Format</b> | <i>Field Length</i>   | <i>Data Descriptor</i> | <i>Message Data</i>  |                    |                  |                           |  |
|                     | 16 (0x10)   | 0x1C                   | <i>Binary Offset</i> | <i>Description</i> | <i>Data Type</i> | <i>Units</i>              |  |
|                     |   |                        | 0                    | X                  | Float            | Meters / Sec <sup>2</sup> |  |
|                     |   |                        | 4                    | Y                  | Float            | Meters / Sec <sup>2</sup> |  |
|                     |   |                        | 8                    | Z                  | Float            | Meters / Sec <sup>2</sup> |  |
| 12                  | Valid Flags   | U16                    | See Notes            |                    |                  |                           |  |

## 5.3.18 Linear Acceleration (0x82, 0x0D)

|                     |   |                        |                      |                    |                  |                           |
|---------------------|---|------------------------|----------------------|--------------------|------------------|---------------------------|
| <b>Description</b>  | Filter-Compensated Linear Acceleration Data (gravity vector removed) expressed in: <ol style="list-style-type: none"> <li>1. The Sensor Frame, if no sensor to body rotation has been defined.</li> <li>2. The Vehicle Frame, if a sensor to body rotation has been defined.</li> </ol> |                        |                      |                    |                  |                           |
| <b>Notes</b>        | Valid Flag Mapping:<br>0x0000 - Linear Accelerations are Invalid<br>0x0001 - Linear Accelerations are Valid   |                        |                      |                    |                  |                           |
| <b>Field Format</b> | <i>Field Length</i>   | <i>Data Descriptor</i> | <i>Message Data</i>  |                    |                  |                           |
|                     | 16 (0x10)   | 0x0D                   | <i>Binary Offset</i> | <i>Description</i> | <i>Data Type</i> | <i>Units</i>              |
|                     |   |                        | 0                    | X                  | Float            | Meters / Sec <sup>2</sup> |
|                     |   |                        | 4                    | Y                  | Float            | Meters / Sec <sup>2</sup> |
|                     |   |                        | 8                    | Z                  | Float            | Meters / Sec <sup>2</sup> |
| 12                  | Valid Flags   | U16                    | See Notes            |                    |                  |                           |



## 5.3.19 Accel Bias (0x82, 0x07)

|                     |   |                        |                      |                    |                  |                           |
|---------------------|---|------------------------|----------------------|--------------------|------------------|---------------------------|
| <b>Description</b>  | Estimated Accel Biases expressed in the Sensor Body Frame.                          |                        |                      |                    |                  |                           |
| <b>Notes</b>        | Valid Flag Mapping:<br>0x0000 - Accel Bias are Invalid<br>0x0001 - Accel Bias Valid |                        |                      |                    |                  |                           |
| <b>Field Format</b> | <i>Field Length</i>   | <i>Data Descriptor</i> | <i>Message Data</i>  |                    |                  |                           |
|                     | 16 (0x10)   | 0x07                   | <i>Binary Offset</i> | <i>Description</i> | <i>Data Type</i> | <i>Units</i>              |
|                     |   |                        | 0                    | X Accel Bias       | Float            | Meters / Sec <sup>2</sup> |
|                     |   |                        | 4                    | Y Accel Bias       | Float            | Meters / Sec <sup>2</sup> |
|                     |   |                        | 8                    | Z Accel Bias       | Float            | Meters / Sec <sup>2</sup> |
| 12                  | Valid Flags   | U16                    | See Notes            |                    |                  |                           |

## 5.3.20 Accel Bias Uncertainty (0x82, 0x0C)

|                     |   |                        |                      |                                    |                  |                           |
|---------------------|---|------------------------|----------------------|------------------------------------|------------------|---------------------------|
| <b>Description</b>  | Estimated Accel Bias 1-sigma Uncertainty expressed in the Sensor Body Frame.                                    |                        |                      |                                    |                  |                           |
| <b>Notes</b>        | Valid Flag Mapping:<br>0x0000 - Accel Bias Uncertainties are Invalid<br>0x0001 - Accel Bias Uncertainties Valid |                        |                      |                                    |                  |                           |
| <b>Field Format</b> | <i>Field Length</i>   | <i>Data Descriptor</i> | <i>Message Data</i>  |                                    |                  |                           |
|                     | 16 (0x10)   | 0x0C                   | <i>Binary Offset</i> | <i>Description</i>                 | <i>Data Type</i> | <i>Units</i>              |
|                     |   |                        | 0                    | 1-Sigma Accel Bias Uncertainty (X) | Float            | Meters / Sec <sup>2</sup> |
|                     |   |                        | 4                    | 1-Sigma Accel Bias Uncertainty (Y) | Float            | Meters / Sec <sup>2</sup> |
|                     |   |                        | 8                    | 1-Sigma Accel Bias Uncertainty (Z) | Float            | Meters / Sec <sup>2</sup> |
| 12                  | Valid Flags   | U16                    | See Notes            |                                    |                  |                           |

## 5.3.21 Accel Scale Factor (0x82, 0x17)

|                     |   |                        |                      |                    |                  |              |
|---------------------|---|------------------------|----------------------|--------------------|------------------|--------------|
| <b>Description</b>  | Estimated Accel Scale Factor expressed in the Sensor Body Frame.  |                        |                      |                    |                  |              |
| <b>Notes</b>        | Valid Flag Mapping:<br>0x0000 - Scale Factor values are Invalid<br>0x0001 - Scale Factor values are Valid |                        |                      |                    |                  |              |
| <b>Field Format</b> | <i>Field Length</i>   | <i>Data Descriptor</i> | <i>Message Data</i>  |                    |                  |              |
|                     | 16 (0x10)   | 0x17                   | <i>Binary Offset</i> | <i>Description</i> | <i>Data Type</i> | <i>Units</i> |
|                     |   |                        | 0                    | X Scale Factor     | Float            | %/100        |
|                     |   |                        | 4                    | Y Scale Factor     | Float            | %/100        |
|                     |   |                        | 8                    | Z Scale Factor     | Float            | %/100        |
| 12                  | Valid Flags   | U16                    | See Notes            |                    |                  |              |

## 5.3.22 Accel Scale Factor Uncertainty (0x82, 0x19)

|                     |   |                        |                      |  |                  |              |
|---------------------|---|------------------------|----------------------|--|------------------|--------------|
| <b>Description</b>  | Estimated Accel Scale Factor 1-Sigma Uncertainty expressed in the Sensor Body Frame.  |                        |                      |  |                  |              |
| <b>Notes</b>        | Valid Flag Mapping:<br>0x0000 - Accel Scale Factor Uncertainties are Invalid<br>0x0001 - Accel Scale Factor Uncertainties Valid |                        |                      |  |                  |              |
| <b>Field Format</b> | <i>Field Length</i>   | <i>Data Descriptor</i> | <i>Message Data</i>  |  |                  |              |
|                     | 16 (0x10)   | 0x19                   | <i>Binary Offset</i> | <i>Description</i>                         | <i>Data Type</i> | <i>Units</i> |
|                     |   |                        | 0                    | 1-Sigma Accel Scale Factor Uncertainty (X) | Float            | %/100        |
|                     |   |                        | 4                    | 1-Sigma Accel Scale Factor Uncertainty (Y) | Float            | %/100        |
|                     |   |                        | 8                    | 1-Sigma Accel Scale Factor Uncertainty (Z) | Float            | %/100        |
| 12                  | Valid Flags   | U16                    | See Notes            |  |                  |              |

## 5.3.23 Pressure Altitude (0x82, 0x21)

|                     |  |                        |                      |                    |                  |              |
|---------------------|--|------------------------|----------------------|--------------------|------------------|--------------|
| <b>Description</b>  | Estimated Pressure Altitude.   |                        |                      |                    |                  |              |
| <b>Notes</b>        | <p>The US 1976 Standard Atmosphere Model is used to calculate the pressure altitude in meters. A valid pressure sensor reading is required for the pressure altitude to be valid. The minimum pressure reading supported by the model is 0.0037 mBar, corresponding to an altitude of 84,852 meters.</p> <p>Valid Flag Mapping:</p> <p style="padding-left: 40px;">0x0000 - Pressure Altitude is Invalid<br/>0x0001 - Pressure Altitude is Valid</p> |                        |                      |                    |                  |              |
| <b>Field Format</b> | <i>Field Length</i>  | <i>Data Descriptor</i> | <i>Message Data</i>  |                    |                  |              |
|                     | 8 (0x08)   | 0x21                   | <i>Binary Offset</i> | <i>Description</i> | <i>Data Type</i> | <i>Units</i> |
|                     |  |                        | 0                    | Pressure Altitude  | Float            | Meters       |
|                     |  |                        | 4                    | Valid Flags        | U16              | See Notes    |

## 5.3.24 Standard Atmosphere Model (0x82, 0x20)

| Description  | Standard Atmosphere Model Solution.   |                        |                      |                       |                  |                   |
|--------------|---|------------------------|----------------------|-----------------------|------------------|-------------------|
| Notes        | <p>The US 1976 Standard Atmosphere Model is used. A valid GNSS location is required for the model to be valid.</p> <p>Valid Flag Mapping:</p> <p style="padding-left: 40px;">0x0000 - Atmosphere model solution is invalid (note: this will be the state when GNSS is unavailable)</p> <p style="padding-left: 40px;">0x0001 - Atmosphere model solution is valid</p> |                        |                      |                       |                  |                   |
| Field Format | <i>Field Length</i>   | <i>Data Descriptor</i> | <i>Message Data</i>  |                       |                  |                   |
|              | 24 (0x18)   | 0x20                   | <i>Binary Offset</i> | <i>Description</i>    | <i>Data Type</i> | <i>Units</i>      |
|              |   |                        | 0                    | Geometric Altitude    | Float            | meters            |
|              |   |                        | 4                    | Geopotential Altitude | Float            | meters            |
|              |   |                        | 8                    | Temperature           | Float            | degC              |
|              |   |                        | 12                   | Pressure              | Float            | mBar              |
|              |   |                        | 16                   | Density               | Float            | kg/m <sup>3</sup> |
|              |   |                        | 20                   | Valid Flags           | U16              | See Notes         |

## 5.3.25 Gravity Vector (0x82, 0x13)

|                     |  |                        |                      |                    |                  |                           |
|---------------------|--|------------------------|----------------------|--------------------|------------------|---------------------------|
| <b>Description</b>  | <p>Estimated Gravity Vector expressed in:</p> <ol style="list-style-type: none"> <li>1. The Sensor Frame, if no sensor to body rotation has been defined.</li> <li>2. The Vehicle Frame, if a sensor to body rotation has been defined.</li> </ol> |                        |                      |                    |                  |                           |
| <b>Notes</b>        | <p>Valid Flag Mapping:</p> <p>0x0000 - Gravity vector is Invalid<br/>0x0001 - Gravity vector is Valid</p>  |                        |                      |                    |                  |                           |
| <b>Field Format</b> | <i>Field Length</i>  | <i>Data Descriptor</i> | <i>Message Data</i>  |                    |                  |                           |
|                     | 16 (0x10)  | 0x13                   | <i>Binary Offset</i> | <i>Description</i> | <i>Data Type</i> | <i>Units</i>              |
|                     |  |                        | 0                    | X                  | Float            | Meters / Sec <sup>2</sup> |
|                     |  |                        | 4                    | Y                  | Float            | Meters / Sec <sup>2</sup> |
|                     |  |                        | 8                    | Z                  | Float            | Meters / Sec <sup>2</sup> |
| 12                  | Valid Flags  | U16                    | See Notes            |                    |                  |                           |

## 5.3.26 WGS84 Local Gravity Magnitude (0x82, 0x0F)

|                     |   |                        |                      |                    |                  |                         |
|---------------------|---|------------------------|----------------------|--------------------|------------------|-------------------------|
| <b>Description</b>  | Local Magnitude of Earth's gravity using the WGS84 gravity model.   |                        |                      |                    |                  |                         |
| <b>Notes</b>        | <p>The -GX5-45 implements the WGS84 gravity model, valid for altitudes of 20 km or less.</p> <p>Valid Flag Mapping:</p> <p>0x0000 - Gravity value is Invalid</p> <p>0x0001 - Gravity value is Valid</p> |                        |                      |                    |                  |                         |
| <b>Field Format</b> | <i>Field Length</i>   | <i>Data Descriptor</i> | <i>Message Data</i>  |                    |                  |                         |
|                     |   |                        | <i>Binary Offset</i> | <i>Description</i> | <i>Data Type</i> | <i>Units</i>            |
|                     | 08 (0x08)   | 0x0F                   | 0                    | Gravity Magnitude  | Float            | Meters/Sec <sup>2</sup> |
|                     |   |                        | 4                    | Valid Flags        | U16              | See Notes               |

## 5.3.27 Heading Update Source State (0x82, 0x14)

| Description  | Heading Update Source information expressed in the sensor frame.   |                        |                      |                             |                  |              |
|--------------|--|------------------------|----------------------|-----------------------------|------------------|--------------|
| Notes        | <p>Heading updates can be applied from a number of sources (listed below. Also see <a href="#">Heading Update Control</a>.)</p> <p>The heading value is always relative to true north.</p> <p>Possible Source Flags (may be combined):</p> <ul style="list-style-type: none"> <li>0x0000 - No source, heading updates disabled</li> <li>0x0001 - Magnetometer</li> <li>0x0002 - GNSS Velocity Vector</li> <li>0x0004 - <a href="#">External Heading Update</a> or <a href="#">External Heading Update with Timestamp</a> Message</li> </ul> <p>Valid Flag Mapping:</p> <ul style="list-style-type: none"> <li>0x0000 - No heading update received in 2 seconds.</li> <li>0x0001 - The heading update source has provided data within 2 seconds.</li> </ul> |                        |                      |                             |                  |              |
| Field Format | <i>Field Length</i>  | <i>Data Descriptor</i> | <i>Message Data</i>  |                             |                  |              |
|              | 14 (0x0E)  | 0x14                   | <i>Binary Offset</i> | <i>Description</i>          | <i>Data Type</i> | <i>Units</i> |
|              |  |                        | 0                    | Heading (True)              | Float            | Radians      |
|              |  |                        | 4                    | Heading 1-sigma Uncertainty | Float            | Radians      |
|              |  |                        | 8                    | Source                      | U16              | See Notes    |
| 10           | Valid Flags  | U16                    | See Notes            |                             |                  |              |



## 5.3.28 Magnetic Model Solution (0x82, 0x15)

| Description  | Magnetic model solution expressed in the NED frame.   |                        |                      |                    |                  |              |
|--------------|---|------------------------|----------------------|--------------------|------------------|--------------|
| Notes        | <p>The World Magnetic Model 2010 is used. A valid GNSS location is required for the model to be valid.</p> <p>Valid Flag Mapping:</p> <p>0x0000 - Magnetic model solution is invalid (note: this will be the state when the magnetic model is recalculating for the current time and location as well as when GNSS is unavailable)</p> <p>0x0001 - Magnetic model solution is valid</p> |                        |                      |                    |                  |              |
| Field Format | <i>Field Length</i>   | <i>Data Descriptor</i> | <i>Message Data</i>  |                    |                  |              |
|              | 24 (0x18)   | 0x15                   | <i>Binary Offset</i> | <i>Description</i> | <i>Data Type</i> | <i>Units</i> |
|              |   |                        | 0                    | Intensity (North)  | Float            | Gauss        |
|              |   |                        | 4                    | Intensity (East)   | Float            | Gauss        |
|              |   |                        | 8                    | Intensity (Down)   | Float            | Gauss        |
|              |   |                        | 12                   | Inclination        | Float            | Radians      |
|              |   |                        | 16                   | Declination        | Float            | Radians      |
|              |   |                        | 20                   | Valid Flags        | U16              | See Notes    |

## 5.3.29 Mag Auto Hard Iron Offset (0x82, 0x25)

|                     |  |                        |                      |                    |                  |              |
|---------------------|--|------------------------|----------------------|--------------------|------------------|--------------|
| <b>Description</b>  | This is an offset vector applied to the hard iron offset vector to compensate for magnetometer in-run bias errors. |                        |                      |                    |                  |              |
| <b>Notes</b>        | Valid Flag Mapping:<br>0x0000 - Vector is Invalid<br>0x0001 - Vector is Valid                                      |                        |                      |                    |                  |              |
| <b>Field Format</b> | <i>Field Length</i>  | <i>Data Descriptor</i> | <i>Message Data</i>  |                    |                  |              |
|                     | 16 (0x10)  | 0x25                   | <i>Binary Offset</i> | <i>Description</i> | <i>Data Type</i> | <i>Units</i> |
|                     |  |                        | 0                    | X                  | Float            | Gauss        |
|                     |  |                        | 4                    | Y                  | Float            | Gauss        |
|                     |  |                        | 8                    | Z                  | Float            | Gauss        |
| 12                  | Valid Flags  | U16                    | See Notes            |                    |                  |              |

## 5.3.30 Mag Auto Hard Iron Offset Uncertainty (0x82, 0x28)

|                     |   |                        |                      |                    |                  |              |
|---------------------|---|------------------------|----------------------|--------------------|------------------|--------------|
| <b>Description</b>  | This is the uncertainty of the Magnetometer Compensation Offset.              |                        |                      |                    |                  |              |
| <b>Notes</b>        | Valid Flag Mapping:<br>0x0000 - Vector is Invalid<br>0x0001 - Vector is Valid |                        |                      |                    |                  |              |
| <b>Field Format</b> | <i>Field Length</i>   | <i>Data Descriptor</i> | <i>Message Data</i>  |                    |                  |              |
|                     | 16 (0x10)   | 0x28                   | <i>Binary Offset</i> | <i>Description</i> | <i>Data Type</i> | <i>Units</i> |
|                     |   |                        | 0                    | X                  | Float            | Gauss        |
|                     |   |                        | 4                    | Y                  | Float            | Gauss        |
|                     |   |                        | 8                    | Z                  | Float            | Gauss        |
| 12                  | Valid Flags   | U16                    | See Notes            |                    |                  |              |

## 5.3.31 Mag Auto Soft Iron Matrix (0x82, 0x26)

| 5.3.31 Mag Auto Soft Iron Matrix (0x82, 0x26) |   |                 |               |                 |           |       |
|---|---|-----------------|---------------|-----------------|-----------|-------|
| Description                                   | Magnetometer Soft Iron compensation matrix.   |                 |               |                 |           |       |
| Notes   | <p>This is a 9 component matrix which is applied to the magnetometer soft iron calibration matrix to compensate for magnetometer in-run errors.</p> <div style="text-align: right; font-size: 2em;">}</div> <p>Valid Flag Mapping:</p> <p>0x0000 - Orientation Matrix is Invalid<br/>0x0001 - Orientation Matrix is Valid</p> |                 |               |                 |           |       |
| Field Format                                  | Field Length  | Data Descriptor | Message Data  |                 |           |       |
|   | 40 (0x28)   | 0x26            | Binary Offset | Description     | Data Type | Units |
|   |   |                 | 0             | M <sub>11</sub> | Float     | n/a   |
|   |   |                 | 4             | M <sub>12</sub> | Float     | n/a   |
|   |   |                 | 8             | M <sub>13</sub> | Float     | n/a   |
|   |   |                 | 12            | M <sub>21</sub> | Float     | n/a   |
|   |   |                 | 16            | M <sub>22</sub> | Float     | n/a   |
|   |   |                 | 20            | M <sub>23</sub> | Float     | n/a   |
|   |   |                 | 24            | M <sub>31</sub> | Float     | n/a   |
|   |   |                 | 28            | M <sub>32</sub> | Float     | n/a   |
|   |   |                 | 32            | M <sub>33</sub> | Float     | n/a   |
| 36  | Valid Flags   | U16             | See Notes     |                 |           |       |

## 5.3.32 Mag Auto Soft Iron Matrix Uncertainty (0x82, 0x29)

| Description  | Magnetometer Soft Iron compensation matrix.  |                        |                      |                    |                  |              |
|--------------|--|------------------------|----------------------|--------------------|------------------|--------------|
| Notes        | <p>This is the uncertainty of the Magnetometer Compensation matrix.</p> <div style="text-align: right; font-size: 2em;">}</div> <p>Valid Flag Mapping:</p> <p style="padding-left: 40px;">0x0000 - Orientation Matrix is Invalid</p> <p style="padding-left: 40px;">0x0001 - Orientation Matrix is Valid</p> |                        |                      |                    |                  |              |
| Field Format | <i>Field Length</i>  | <i>Data Descriptor</i> | <i>Message Data</i>  |                    |                  |              |
|              | 40 (0x28)  | 0x29                   | <i>Binary Offset</i> | <i>Description</i> | <i>Data Type</i> | <i>Units</i> |
|              |  |                        | 0                    | M <sub>11</sub>    | Float            | n/a          |
|              |  |                        | 4                    | M <sub>12</sub>    | Float            | n/a          |
|              |  |                        | 8                    | M <sub>13</sub>    | Float            | n/a          |
|              |  |                        | 12                   | M <sub>21</sub>    | Float            | n/a          |
|              |  |                        | 16                   | M <sub>22</sub>    | Float            | n/a          |
|              |  |                        | 20                   | M <sub>23</sub>    | Float            | n/a          |
|              |  |                        | 24                   | M <sub>31</sub>    | Float            | n/a          |
|              |  |                        | 28                   | M <sub>32</sub>    | Float            | n/a          |
|              |  |                        | 32                   | M <sub>33</sub>    | Float            | n/a          |
| 36           | Valid Flags  | U16                    | See Notes            |                    |                  |              |

## 5.3.33 GNSS Antenna Offset Correction (0x82, 0x30)

|                     |   |                        |                      |                     |                  |              |
|---------------------|---|------------------------|----------------------|---------------------|------------------|--------------|
| <b>Description</b>  | Estimated GNSS Antenna Offset Correction expressed in the Sensor Body Frame as the vector from the IMU to the GNSS Antenna.                   |                        |                      |                     |                  |              |
| <b>Notes</b>        | Valid Flag Mapping:<br>0x0000 - GNSS Antenna Offset Correction values are Invalid<br>0x0001 - GNSS Antenna Offset Correction values are Valid |                        |                      |                     |                  |              |
| <b>Field Format</b> | <i>Field Length</i>   | <i>Data Descriptor</i> | <i>Message Data</i>  |                     |                  |              |
|                     | 16 (0x10)   | 0x30                   | <i>Binary Offset</i> | <i>Description</i>  | <i>Data Type</i> | <i>Units</i> |
|                     |   |                        | 0                    | X Offset Correction | Float            | Meters       |
|                     |   |                        | 4                    | Y Offset Correction | Float            | Meters       |
|                     |   |                        | 8                    | Z Offset Correction | Float            | Meters       |
| 12                  | Valid Flags   | U16                    | See Notes            |                     |                  |              |

## 5.3.34 GNSS Antenna Offset Correction Uncertainty (0x82, 0x31)

|                     |   |                        |                      |   |                  |              |
|---------------------|---|------------------------|----------------------|---|------------------|--------------|
| <b>Description</b>  | Estimated GNSS Antenna Offset Correction Uncertainty expressed in the Sensor Body Frame.  |                        |                      |   |                  |              |
| <b>Notes</b>        | Valid Flag Mapping:<br>0x0000 - GNSS Antenna Offset Correction Uncertainties are Invalid<br>0x0001 - GNSS Antenna Offset Correction Uncertainties Valid |                        |                      |   |                  |              |
| <b>Field Format</b> | <i>Field Length</i>   | <i>Data Descriptor</i> | <i>Message Data</i>  |   |                  |              |
|                     | 16 (0x10)   | 0x31                   | <i>Binary Offset</i> | <i>Description</i>                        | <i>Data Type</i> | <i>Units</i> |
|                     |   |                        | 0                    | 1-Sigma Offset Correction Uncertainty (X) | Float            | Meters       |
|                     |   |                        | 4                    | 1-Sigma Offset Correction Uncertainty (Y) | Float            | Meters       |
|                     |   |                        | 8                    | 1-Sigma Offset Correction Uncertainty (Z) | Float            | Meters       |
| 12                  | Valid Flags   | U16                    | See Notes            |   |                  |              |

## 6 MIP Packet Reference

### 6.1 Structure

Commands and Data are sent and received as fields in the LORD “MIP” packet format. Below is the general definition of the structure:

The packet always begins with the start-of-packet sequence “ue” (0x75, 0x65). The “Descriptor Set” byte in the header specifies which command or data set is contained in fields of the packet. The payload length byte specifies the sum of all the field length bytes in the payload section.

### 6.2 Payload Length Range

The payload section can be empty or can contain one or more fields. Each field has a length byte and a descriptor byte. The field length byte specifies the length of the entire field including the field length byte and field descriptor byte. The descriptor byte specifies the command or data that is contained in the field data. The descriptor can only be from the set of descriptors specified by the descriptor set byte in the header. The field data can be anything but is always rigidly defined. The definition of a descriptor is fundamentally described in a “.h” file that corresponds to the descriptor set that the descriptor belongs to.

LORD Sensing provides a “Packet Builder” functionality in the “MIP Monitor” software utility to simplify the construction of a MIP packet. Most commands will have a single field in the packet, but multiple field packets are possible. Extensive examples complete with checksums are given in the command reference section.

### 6.3 MIP Checksum Range

The checksum is a 2 byte Fletcher checksum and encompasses all the bytes in the packet:

### 6.4 16-bit Fletcher Checksum Algorithm (C Language)

```
for(i=0; i<checksum_range; i++)
{
    checksum_byte1 += mip_packet[i];
    checksum_byte2 += checksum_byte1;
}

checksum = ((u16) checksum_byte1 << 8) + (u16) checksum_byte2;
```

## 7 Advanced Programming

### 7.1 Multiple Commands in a Single Packet

MIP packets may contain one or more individual commands. In the case that multiple commands are transmitted in a single MIP packet, the 3DM-GX5-45 will respond with a single packet containing multiple replies. As with any packet, all commands must be from the same descriptor set (you cannot mix Base commands with 3DM commands in the same packet).

Below is an example that shows how you can combine the commands from step 2 and 3 of the [Example Setup Sequence](#) into a single packet. The commands are from the 3DM set. The command packet has two fields as does the reply packet (the fields are put on separate rows for clarity):

| Examples   | MIP Packet Header |              |                  |                       | Command/Reply Fields |                  |  | Checksum   |            |
|--|-------------------|--------------|------------------|-----------------------|----------------------|------------------|--|------------|------------|
|  | <i>Sync1</i>      | <i>Sync2</i> | <i>Desc. Set</i> | <i>Payload Length</i> | <i>Field Length</i>  | <i>Cmd Desc.</i> | <i>Field Data</i>  | <i>MSB</i> | <i>LSB</i> |
| <i>Command Field 1: Set IMU Message Format</i>   | 0x75              | 0x65         | 0x0C             | 0x20                  | 0x0D                 | 0x08             | Function: 0x01<br>Desc. count: 0x03<br>GPS TS Descriptor: 0x12<br>Rate Dec: 0x000A<br>Accel Descriptor: 0x04<br>Rate Dec: 0x000A<br>Ang Rate Descriptor: 0x05<br>Rate Dec: 0x000A  |            |            |
| <i>Command Field 2: Set EF Message Format</i>  |                   |              |                  |                       | 0x13                 | 0x0A             | Function: 0x01<br>Desc. count: 0x05<br>GPS TS Desc.: 0x11<br>Rate Dec: 0x000A<br>Filter Status Desc: 0x10<br>Rate Dec: 0x000A<br>Est. Pos. Desc.: 0x01<br>Rate Dec: 0x000A<br>Est. Vel. Desc.: 0x02<br>Rate Dec: 0x000A<br>Est. Quat. Desc: 0x03<br>Rate Dec: 0x000A | 0xD4       | 0x3D       |
| <i>Reply Field 1: ACK/NACK</i>   | 0x75              | 0x65         | 0x0C             | 0x08                  | 0x04                 | 0xF1             | Echo cmd: 0x08<br>Error code: 0x00   |            |            |
| <i>Reply Field 2: ACK/NACK</i>   |                   |              |                  |                       | 0x04                 | 0xF1             | Echo cmd: 0x0A<br>Error code: 0x00   | 0xEA       | 0x71       |
| <i>Copy-paste version of the command: "7565 0C20 0D08 0103 1200 0A04 000A 0500 0A13 0A01 0511 000A 1000 0A01 000A 0200 0A03 000A D43D"</i> |                   |              |                  |                       |                      |                  |  |            |            |



*Note that the only difference in the packet headers of the single command packets compared to the multiple command packets is the payload length. Parsing multiple fields in a single packet involves subtracting the field length of the next field from the payload length until the payload length is less than or equal to zero.*

## 7.2 Direct Modes

The 3DM-GX5-45 has special “direct” modes that switch the device into a Sensor direct or GNSS direct device. The [Device Communications Mode](#) command is used to switch between modes. When in these modes, the 3DM-GX5-45 acts like an “IMU only” sensor. Any code or tools developed for these devices may be used in these modes.

These modes can be used to access advanced (native) data of the individual sensors, data that isn’t represented in the 3DM command sets of the 3DM-GX5-45. These modes are primarily advanced modes for programmers to allow the 3DM-GX5-45 to be used in unusual situations where the normal functions of the 3DM-GX5-45 are bypassed.

**IMPORTANT:** *When you switch modes, you are switching to a new device protocol EXCEPT for two commands: the [Device Communications Mode](#) and [Device Status](#) commands. Those commands are always available regardless of which mode you are in. For example, if you switch to GNSS direct mode, then the protocol recognized by the device is NMEA and UBX protocol, however the 3DM-GX5-45 is still “listening” for mode switch or device status commands and will respond to them. It will not respond to any other 3DM-GX5-45 Base or 3DM commands until switched back to the “Standard Mode”.*

## 7.3 Internal Diagnostic Functions

The 3DM-GX5-45 supports two device specific internal functions used for diagnostics and system status. These are [Device Built In Test](#) and [Device Status](#). These commands are defined generically but the implementation is very specific to the hardware implemented on this device. Other LORD Sensing devices will have their own implementations of these functions depending on the internal hardware of the devices.

### 7.3.1 3DM-GX5-45 Internal Diagnostic Commands

- [Device Built In Test](#) (0x01, 0x05)
- [Device Status](#) (0x0C, 0x64)

## 7.4 Handling High Rate Data

The size of the data fields from an inertial device is substantially greater than on most other types of sensors. On top of that, in many applications it is desirable to receive that data with the lowest latency possible and thus the highest baud rate is selected. The result is that the port servicing requirements in terms of both speed and buffer size can be surprisingly large for inertial data. This can lead to a couple of common problems: runaway latency and dropped packets.

### 7.4.1 Runaway Latency

Most operating systems provide drivers that have ample buffers and take care of port servicing at the hardware level. Dropping packets or losing data is not usually an issue on these systems. What can be an issue is latency, that is, when the buffer is not emptied by the application in a timely manner. In the worst case, the buffer is being filled faster than it is emptied and the application operates with increasingly “old” data - which causes runaway latency. It is important to monitor the incoming data buffer to make sure you do not reach this condition.

### 7.4.2 Dropped Packets

Many applications do not use an operating system but are written from scratch or on top of proprietary application frameworks. These are most often embedded MCUs or small single board microcontrollers. On these systems, port handling is usually done in code at the hardware level. Collecting data from a port requires the use one of three techniques: register polling, hardware interrupts, or direct memory access (DMA). Register polling is very easy to do and is adequate for simple communications where data comes in very small chunks and at reasonable data rates. The problem with register polling is that you either waste time looping while waiting for a byte to come in at the port or you get too busy doing other tasks so that by the time you poll the port, the byte is lost because the next one overwrites it. This causes dropped packets. On these systems, it is imperative to utilize either a hardware interrupt or hardware DMA on the UART receiving data from the 3DM-GX5-45. The DMA or UART interrupt service routine only takes processor time when a byte is ready and as long as the interrupts are preemptive, the processor will fetch every byte received. Using the interrupt routine to fill a ring buffer makes the most efficient use of an MCU and makes it easier to write your application main line code. This is essentially what drivers in operating systems do.

## 7.5 Creating Fixed Data Packet Format

The MIP packet structure and protocol provides a great deal of flexibility to the user for creating a custom data stream. It does this by allowing selectable data fields and individual data rates for each field. The side effect of this feature is that packets vary in size depending on what data is being delivered in any particular time frame. For example, if acceleration data is configured for 100 Hz and magnetometer data is configured for 25 Hz, every fourth packet is larger than the previous three because of the additional magnetometer data. In some applications, this is undesirable and there may be a requirement for a fixed packet structure so that each data packet is exactly the same. A fixed packet structure allows you to find data fields by fixed offsets rather than parsing the packet for each field.

A fixed packet structure is easily achieved with MIP packet protocol by simply making sure the data rate for each data quantity is the same. The order of the data fields in the packet reflect the order of the fields in the [Message Format](#) command and thus are completely under the control of the user. Once an acceptable data packet structure is determined, and all the rates are set to the same decimation, use the “Save current settings as startup settings” function selector in the message format command, and that format will be saved and used automatically on subsequent device startups. The message formats for each of the data classes (IMU, EF, etc.) work the same way, however the available data rates for each class is different, so you will need to create a fixed message format for each one.

## 7.6 Advanced Programming Models

Many applications will only require a single threaded programming model which is simple to implement using a single program loop that services incoming packets. In other applications, advanced techniques such as multithreading or event based processes are required. The MIP packet design simplifies implementation of these models. It does this by limiting the packet size to a maximum of 261 bytes and it provides the “descriptor set” byte in the header. The limited packet size makes scalable packet buffers possible even with limited memory space. The descriptor set byte aids in sorting an incoming packet stream into one or more command-reply packet queues and/or data packet queues. A typical multithreaded environment will have a command/control thread and one or more data processing threads. Each of these threads can be fed with individual incoming packet queues, each containing packets that only pertain to that thread - sorted by descriptor set. Packet queues can easily be created dynamically as threads are created and destroyed. All packet queues can be fed by a single incoming packet parser that runs continuously independent of the queues. The packet queues are individually scaled as appropriate to the process; smaller queues for lower latency and larger queues for more efficient batch processing of packets.

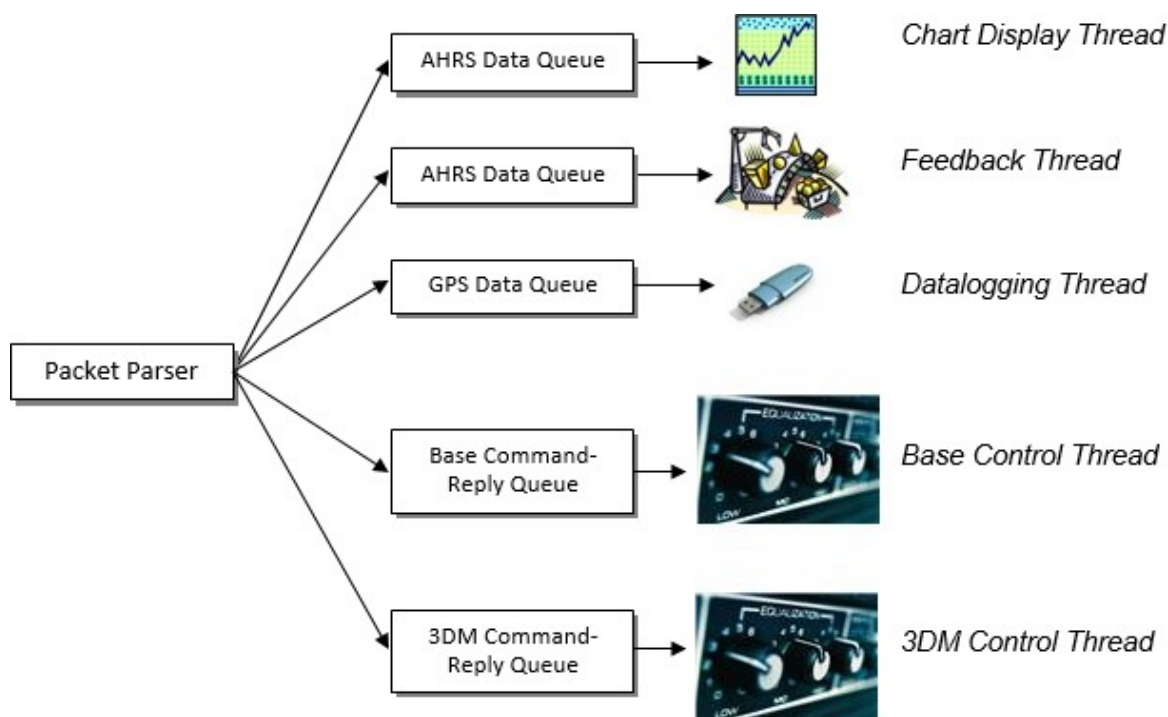

*Multithreaded application with multiple incoming packet queues*

## 8 Glossary

### A

#### A/D Value

The digital representation of analog voltages in an analog-to-digital (A/D) conversion. The accuracy of the conversion is dependent on the resolution of the system electronics. Higher resolution produces a more accurate conversion.

#### Acceleration

In physics, acceleration is the change in the rate of speed (velocity) of an object over time.

#### Accelerometer

A sensor used to detect and measure magnitude and direction of an acceleration force (g-force) in reference to its sensing frame. For example, at rest perpendicular to the Earth's surface an accelerometer will measure 9.8 meters/second squared as a result of gravity. If the device is tilted the acceleration force will change slightly, indicating tilt of the device. When the accelerometer is moving it will measure the dynamic force (including gravity).

#### Adaptive Kalman Filter (AKF)

A type of Extended Kalman Filter (EKF) that contains an optimization algorithm that adapts to dynamic conditions with a high dependency on adaptive technology. Adaptive technology refers to the ability of a filter to selectively trust a given measurement more or less based on a trust threshold when compared to another measurement that is used as a reference. Sensors that have estimation filters that rely on adaptive control elements to improve their estimations are referred to as an AKF.

#### AHRS (Attitude and Heading Reference System)

A navigation device consisting of sensors on the three primary axes used to measure vehicle direction and orientation in space. The sensor measurements are typically processed by an onboard algorithm, such as an Estimation Filter, to produce a standardized output of attitude and heading.

#### Algorithm

In math and science, an algorithm is a step-by-step process used for calculations.

#### Altitude

the distance an object is above the sea level

#### Angular rate

The rate of speed of which an object is rotating. Also known as angular frequency, angular speed, or radial frequency. It is typically measured in radians/second.

#### API (Applications Programming Interface)

A library and/or template for a computer program that specifies how components will work together to form a user application: for example, how hardware will be accessed and what data structures and variables will be used.

**ASTM (Association of Standards and Testing)**  
a nationally accepted organization for the testing and calibration of technological devices

**Attitude**  
the orientation of an object in space with reference to a defined frame, such as the North-East-Down (NED) frame

**Azimuth**  
A horizontal arc measured between a fixed point (such as true north) and the vertical circle passing through the center of an object

**B**

**Bias**  
A non-zero output signal of a sensor when no load is applied to it, typically due to sensor imperfections. It is also called offset.

**C**

**Calibration**  
to standardize a measurement by determining the deviation standard and applying a correction, or calibration, factor

**Complementary Filter (CF)**  
A term commonly used for an algorithm that combines the readings from multiple sensors to produce a solution. These filters typically contain simple filtering elements to smooth out the effects of sensor over-ranging or anomalies in the magnetic field.

**Configuration**  
A general term applied to the sensor indicating how it is set up for data acquisition. It includes settings such as sampling rate, active measurements, measurement settings, offsets, biases, and calibration values

**Convergence**  
when mathematical computations approach a limit or a solution that is stable and optimal.

**D**

**Data Acquisition**  
the process of collecting data from sensors and other devices

**Data Logging**  
the process of saving acquired data to the system memory, either locally on the device, or remotely on the host computer

**Data rate**  
the rate at which sampled data is transmitted to the host

**Delta-Theta**

the time integral of angular rate expressed with reference to the device local coordinate system, in units of radians

**Delta-velocity**

the time integral of velocity expressed with reference to the device local coordinate system, in units of g\*second where g is the standard gravitational constant

**E**

**ECEF (Earth Centered Earth Fixed)**

a reference frame that is fixed to the earth at the center of the earth and turning about earth's axis in the same way as the earth

**Estimation Filter**

A mathematical algorithm that produces a statistically optimum solution using measurements and references from multiple sources. Best known estimation filters are the Kalman Filter, Adaptive Kalman Filter, and Extended Kalman Filter.

**Euler angles**

Euler angles are three angles use to describe the orientation of an object in space such as the x, y and z or pitch; roll; and yaw. Euler angles can also represent a sequence of three elemental rotations around the axes of a coordinate system.

**Extended Kalman Filter (EKF)**

Used generically to describe any estimation filter based on the Kalman Filter model that can handle non-linear elements. Almost all inertial estimation filters are fundamentally EKFs.

**G**

**GNSS (Global Navigation Satellite System)**

a global network of space based satellites (GPS, GLONASS, BeiDou, Galileo, and others) used to triangulate position co-ordinates and provide time information for navigational purposes

**GPS (Global Positioning System)**

a U.S. based network of space based satellites used to triangulate position co-ordinates and provide time information for navigational purposes

**Gyroscope**

a device used to sense angular movements such as rotation

**H**

**Heading**

an object's direction of travel with reference to a co-ordinate frame, such as latitude and longitude

Host (computer)

The host computer is the computer that orchestrates command and control of attached devices or networks.

I IMU

Inertial Measurement System

Inclinometer

device used to measure tilt, or tilt and roll

Inertial

pertaining to systems that have inertia or are used to measure changes in inertia as in angular or linear accelerations

INS (Inertial Navigation System)

systems that use inertial measurements exclusively to determine position, velocity, and attitude, given an initial reference

K

Kalman Filter

a linear quadratic estimation algorithm that processes sensor data or other input data over time, factoring in underlying noise profiles by linearizing the current mean and covariance to produce an estimate of a system's current state that is statistically more precise than what a single measurement could produce

L

LOS (Line of Sight)

Describes the ideal condition between transmitting and receiving devices in a wireless network. As stated, it means they are in view of each other with no obstructions.

M

Magnetometer

A type of sensor that measures the strength and direction of the local magnetic field with reference to the sensor frame. The magnetic field measured will be a combination of the earth's magnetic field and any magnetic field created by nearby objects.

MEMS (Micro-Electro-Mechanical System)

The technology of miniaturized devices typically made using micro fabrication techniques such as nanotechnology. The devices range in size from one micron to several millimeters and may include very complex electromechanical parts.



## N

### NED (North-East-Down)

A geographic reference system

### O OEM

acronym for Original Equipment Manufacturer

### Offset

A non-zero output signal of a sensor when no load is applied to it, typically due to sensor imperfections. Also called bias.

### Orientation

The orientation of an object in space with reference to a defined frame. Also called attitude.

## P

### Pitch

In navigation pitch is what occurs when vertical force is applied at a distance forward or aft from the center of gravity of the platform, causing it to move up or down with respect to the sensor or platform frame origin.

### Position

The spatial location of an object

### PVA

acronym for Position, Velocity, Attitude

## Q

### Quaternion

Mathematical notation for representing orientation and rotation of objects in three dimensions with respect to the fixed earth coordinate quaternion. Quaternions convert the axis-angle representation of the object into four numbers and to apply the corresponding rotation to a position vector representing a point relative to the origin.

## R

### Resolution

In digital systems, the resolution is the number of bits or values available to represent analog voltages or information. For example, a 12-bit system has 4096 bits of resolution and a 16-bit system has 65536 bits.

## RMS

acronym for Root Mean Squared

## Roll

In navigation roll is what occurs when a horizontal force is applied at a distance right or left from the center of gravity of the platform, causing it to move side to side with respect to the sensor or platform frame origin.

## RPY

acronym for Roll, Pitch, Yaw

## RS232

a serial data communications protocol

## RS422

a serial data communications protocol

## S

### Sampling

the process of taking measurements from a sensor or device

### Sampling rate

rate at which the sensors are sampled

### Sampling Rate

the frequency of sampling

## Sensor

a device that physically or chemically reacts to environmental forces and conditions and produces a predictable electrical signal as a result

## Sigma

In statistics, sigma is the standard deviation from the mean of a data set.

Space Vehicle Information refers to GPS satellites

## Streaming

typically when a device is sending data at a specified data rate continuously without requiring a prompt from the host

## U

### USB (Universal Serial Bus)

A serial data communications protocol

UTC (Coordinated Universal Time)

The primary time standard for world clocks and time. It is similar to Greenwich Mean Time (GMT).

V

Vector

a measurement with direction and magnitude with reference from one point in space to another

Velocity

The rate of change of position with respect to time. Also called speed.

W

WAAS (Wide Area Augmentation System)

An air navigation aid developed to allow aircraft to rely on GPS for all phases of flight, including precision approaches to any airport.

WGS (World Geodetic System)

a protocol for geo-referencing such as WGS-84

Y

Yaw

In navigation yaw is what occurs when rotational force is applied at a distance forward or aft from the center of gravity of the platform, causing it to move around the center axis of a sensor or platform frame origin.