

G-Link[®]-200

Wireless Accelerometer Node

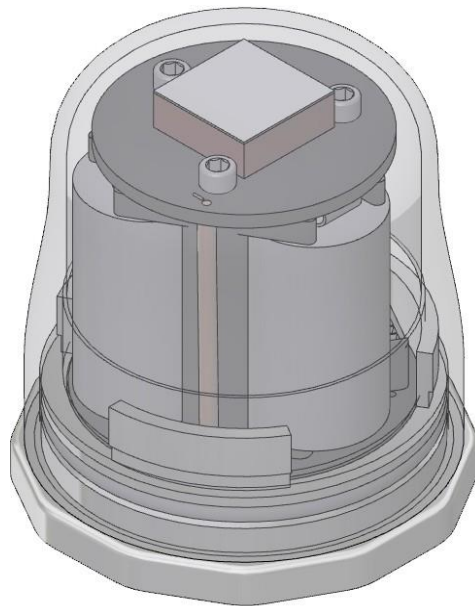



LORD Sensing Systems
459 Hurricane Lane
Suite 102
Williston, VT 05495
United States of America

Phone: 802-862-6629
Fax: 802-863-4093

<http://www.microstrain.com>
sensing_support@LORD.com
sensing_sales@LORD.com

Document 8500-0069 RevisionD

Subject to change without notice.

Table of Contents

1. Wireless Sensor Network Overview	6
2. Node Overview	7
2.1 Components List	8
2.2 Interface and Indicators	9
2.3 Node Operational Modes	10
3. System Operation	11
3.1 Software Installation	11
3.2 Gateway USB Communication	12
3.3 Connect to Nodes	13
3.3.1 Add A Node Via Node Discovery	13
3.3.2 Add A Node Manually	14
3.3.3 Move Node To Base Station Frequency	16
4. Wireless Sensor Configuration	18
4.1 Hardware Configuration	18
4.2 Calibration Configuration	20
4.3 Sampling Configuration	21
4.4 Power	23
5. Wireless Sensor Sampling Configuration	24
5.1 Start Collecting Data	24
5.2 Network Options	25
5.3 Raw Waveform Channels	27
5.4 Derived Output Channels	28
5.4.1 Windows	29
5.4.2 Chunks	31
5.4.3 Under-sampling	31
5.4.4 Incoherence	32

5.5	Sampling Operations Options	32
5.6	Data Type	34
5.7	Output Operation	35
6.	Viewing Data	36
6.1	SensorCloud	36
6.1.1	Connect to SensorCloud	37
6.1.2	Navigating Menus	37
6.2	SensorConnect	40
6.2.1	Using Dashboards and Widgets	40
6.2.2	Navigating Graphs	40
6.2.3	Widgets Options	41
6.2.4	Time Series Widget Menu	41
6.2.5	Exporting Data Files	42
7.	Installation	43
7.1	Mounting Recommendations	43
7.2	Optimizing the Radio Link	45
7.2.1	Range Test	46
8.	Troubleshooting	47
8.1	Troubleshooting Guide	47
8.2	Updating Node Firmware	51
8.3	Repair and Calibration	52
9.	Parts and Configurations	53
9.1	Node Accessories	53
9.2	Wireless System Equipment	53
10.	Specifications	54
10.1	Physical Specifications	54
10.2	Operating Specifications	55

11. Safety Information	57
11.1 Powering the Node.....	57
11.2 Replacing Batteries.....	57
11.3 Battery Hazards.....	58
11.4 Disposal and Recycling.....	58
11.5 Radio Specifications.....	59
11.6 Frequency Setting.....	59
12. References	61
12.1 Technical Support.....	61
12.2 Product Ordering.....	62
12.3 Related Documents.....	62
14. Glossary	67

1. Wireless Sensor Network Overview

The LORD Sensing Wireless Sensor Network is a high-speed, scalable, sensor data acquisition and sensor networking system. Each system consists of wireless sensor interface nodes, a data collection gateway, and full-featured user software platforms based on the LORD Sensing Lossless Extended Range Synchronized (LXRS) data communications protocol. Bi-directional wireless communication between the node and gateway enables sensor data collection and configuration. Gateways can be connected locally to a host computer or remotely via local and mobile networks. Some gateways also feature analog outputs for porting sensor data directly to stand-alone data acquisition equipment.

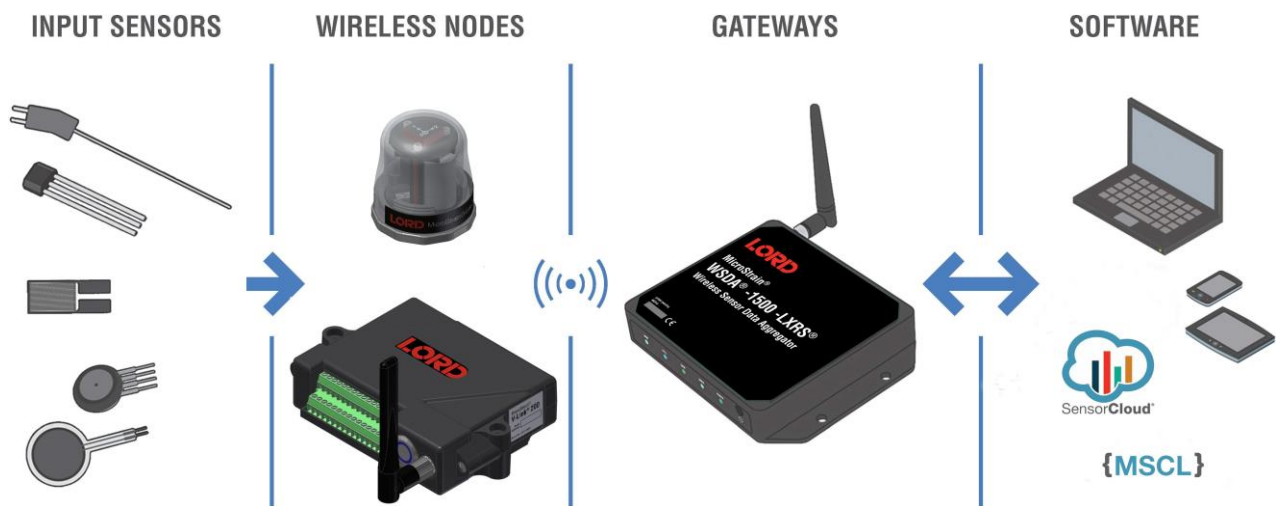

The selection of available nodes allows interface with many types of sensors, including accelerometers, strain gauges, pressure transducers, load cells, torque and vibration sensors, magnetometers, 4 to 20mA sensors, thermocouples, RTD sensors, soil moisture and humidity sensors, inclinometers, and orientation and displacement sensors. Some nodes come with integrated sensing devices such as accelerometers. System sampling capabilities include lossless synchronized sampling, continuous and periodic burst sampling, and data logging. A single gateway can coordinate many nodes of any type, and multiple gateways can be managed from one computer with the SensorConnect and SensorCloud software platforms. Integration to customer systems can be accomplished using OEM versions of the sensor nodes and leveraging the LORD Sensing data communications protocol.

Common wireless applications of LORD Sensing Sensing Systems are strain sensor measurement, accelerometer platforms, vibration monitoring, energy monitoring, environmental monitoring, and temperature monitoring.

2. Node Overview

The G-Link-200 wireless accelerometer node features an on-board triaxial accelerometer that allows high-resolution data acquisition at noise levels as low as 25 or 80 $\mu\text{g}/\text{Hz}$. The G-Link-200 can output continuous waveform data, or one of four derived channels, including Velocity (IPS_{rms}), Amplitude (G_{rms} and $G_{\text{pk-pk}}$) and Crest Factor, allowing long-term monitoring of key performance indicators while maximizing battery life.

G-Link-200 inputs are 20-bit resolution with $\pm 0.1\%$ full scale measurement accuracy. The node can log data to internal memory, transmit real-time synchronized data, and it supports event driven triggers with both pre- and post-event buffers.

To acquire sensor data, the G-Link-200 is used with a LORD Sensing data gateway such as the WSDA-101 or WSDA-1500Base.



Figure 1 - G-Link-200

2.1 Components List

G-Link-200 sensor nodes come with the following components and options. For a complete list of available configurations, accessories, additional system products and ordering information, [see Parts and Configurations on page 53](#).



Item	Description	Quantity
A	G-Link-200	1
B	½ AA, 3.6 V Lithium Batteries	3
--	Calibration Certificate	1

2.2 Interface and Indicators

The G-Link-200 LEDs indicate operational modes showing when the node is booting up, idle and waiting for a command, sampling, resynchronizing, or if there is an error.

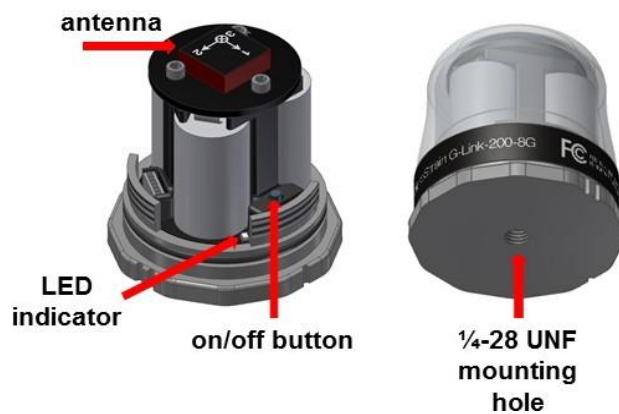

Indicator	Behavior	Node Status
Device status indicator	OFF	Node is OFF
	Rapid green flashing on start-up	Node is booting up
	1 (slow) green pulse per second	Node is idle and waiting for a command
	1 green blink every 2 seconds	Node is sampling
	Blue LED during sampling	Node is resynchronizing
	Red LED	Error or low battery

Table 1 - Indicator Behaviors

2.3 Node Operational Modes

Sensor nodes have three operational modes: *active*, *sleep*, and *idle*. When the node is sampling, it is in active mode. When sampling stops, the node is switched into idle mode, which is used for configuring node settings, and allows toggling between sampling and sleeping modes. The node will automatically go into the ultra low-power sleep mode after a user-determined period of inactivity. The node will not go into sleep mode while sampling.

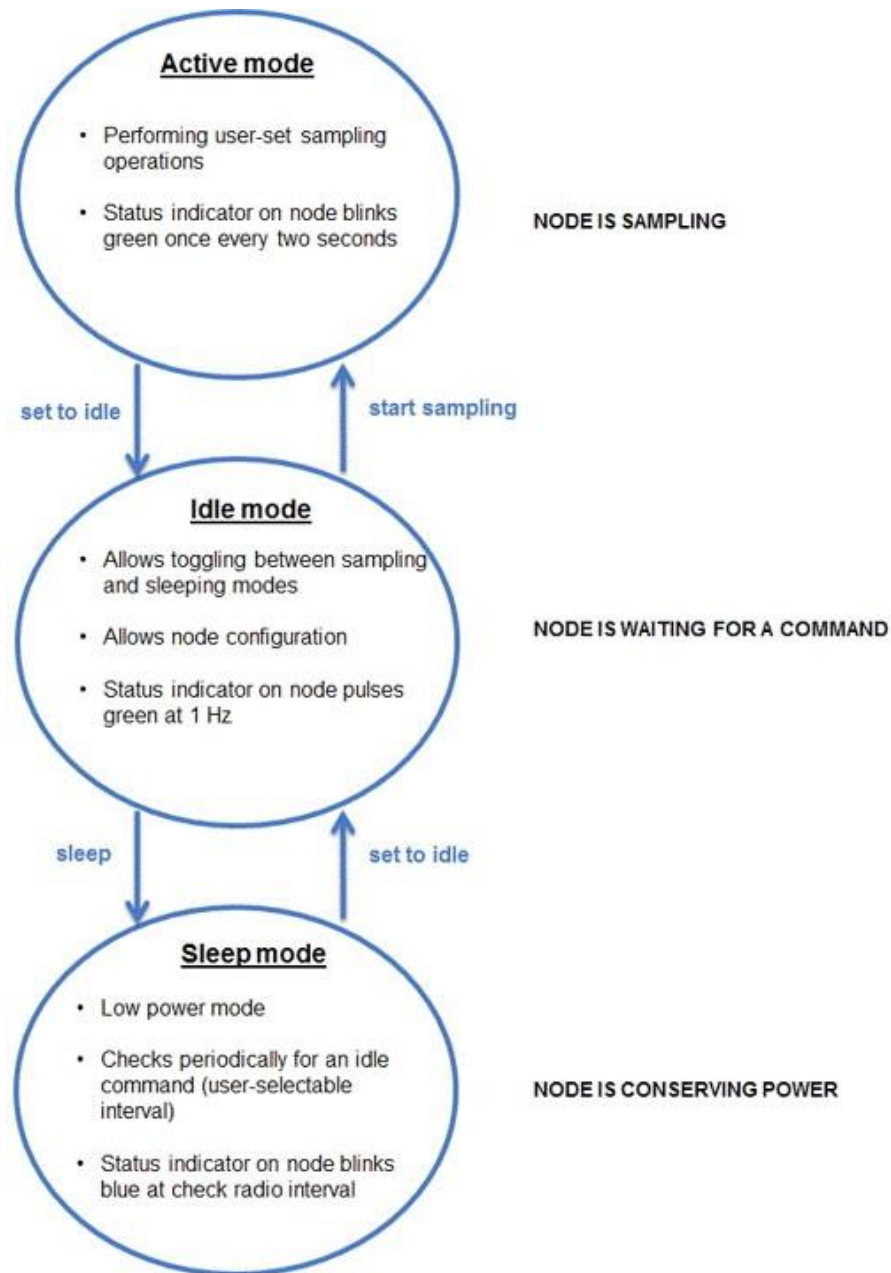

Figure 2 - Node Operational Modes

3. System Operation

The gateway is the interface between LORD Sensing sensor nodes and the data acquisition computer. The gateway co-ordinates the configuration and sampling of the nodes and can handle many nodes simultaneously. Communication between the nodes and gateway is wireless and uses the LORD Sensing LXRS and LXRS+ data communications protocols.

LORD Sensing has two software programs available for data acquisition from the wireless sensor network: SensorCloud and SensorConnect. SensorCloud is an optional web-based data collection, visualization, analysis, and remote management platform based on cloud computing technology. SensorConnect is PC-based software used for configuring gateways and nodes, selecting sampling modes and parameters, initializing data acquisition, and viewing and saving data.

3.1 Software Installation

Install the **SensorConnect** software on the host computer before connecting any hardware. Access the free software download on the LORD Sensing website at:



<http://www.microstrain.com/software>

NOTE

The SensorConnect software includes hardware drivers required for use with USB gateways. Once installed, the software will automatically detect and configure any USB gateways that are plugged into the host computer.

SensorCloud is an optional data collection, visualization, analysis, and remote management tool. It is based on cloud computing technology and is accessed directly from a web connection. For more information go to: <http://www.sensorcloud.com/>.



3.2 Gateway USB Communication

Drivers for the USB gateways are included the SensorConnect software installation. With the software installed, the USB gateway will be detected automatically whenever the gateway is plugged in.

1. Power is applied to the gateway through the USB connection. Verify the gateway status indicator is illuminated, showing the gateway is connected and powered on.
2. Open the SensorConnect software.
3. The gateway should appear in the Controller window automatically with a communication port assignment. If the gateway is not automatically discovered, verify the port is active on the host computer, and then remove and re-insert the USB connector.



Figure 3 - USB Gateway Communication

3.3 Connect to Nodes

Several methods can be used in SensorConnect to establish communication with the nodes: the automatic node discovery feature, manually entering the node address, and scanning transmission frequency and node address ranges.

3.3.1 Add A Node Via Node Discovery

If the base and node are on the same operating frequency, the node will populate below the Base Station listing when powering on the G-Link-200.

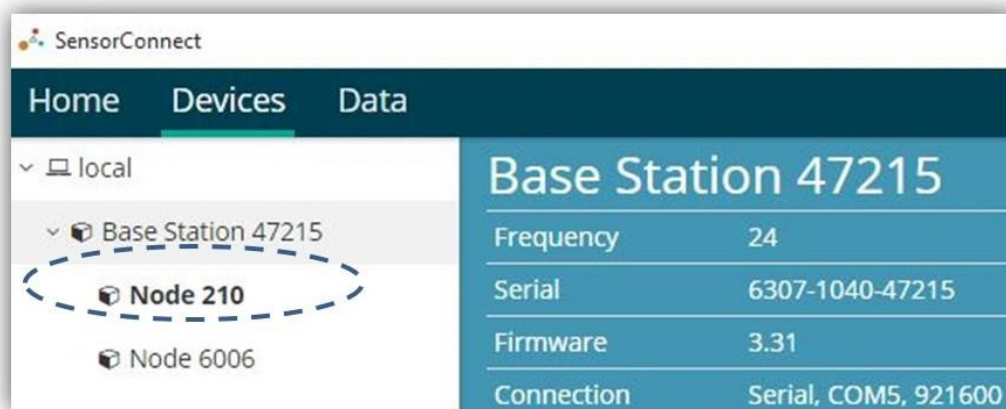

Figure 4 - Node Discovered On Same Frequency

If a red circle with a number appears next to the Base Station, the node is operating on a separate radio channel ([see Move Node To Base Station Frequency on page 16](#)).



Figure 5 - Node On Other Frequency

3.3.2 Add A Node Manually

Adding a node manually requires entering the node address and its current frequency setting.

From the Base Station, select the Manual Add Node tile, enter the Node Address, last known Frequency (factory default is 15), and select Add Node.

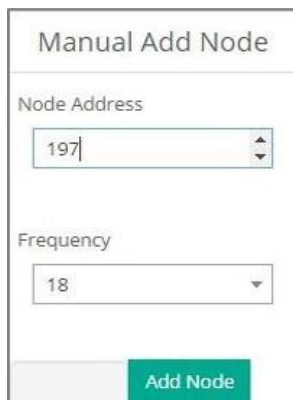

Figure 6 - Add Node By Address

If the node was successfully added, two confirmation messages will appear and it will be listed under the Base Station.

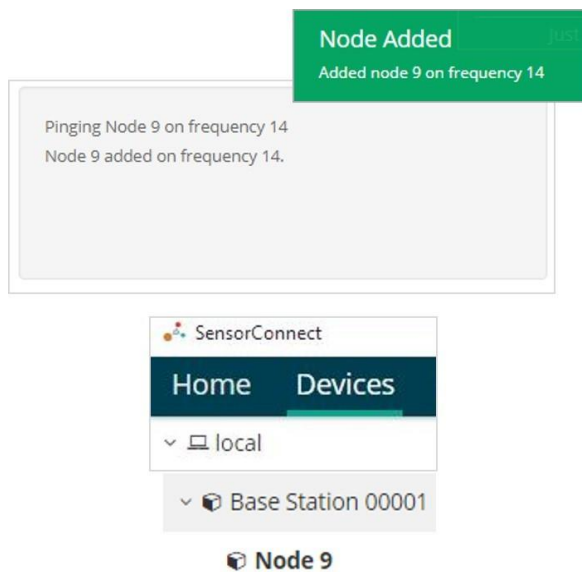

Figure 7 - Add Node Confirmation

If the node failed to be added, a failure message will appear. This means the node did not respond to the base station which could indicate the node is not in idle mode or it may be on another frequency. If "Add Node Anyway" is selected, it will associate that node with the channel entered but it is likely there will be a communication error. If the node was not in idle, move the base station to the frequency of the node and issue a "Set to Idle" command.

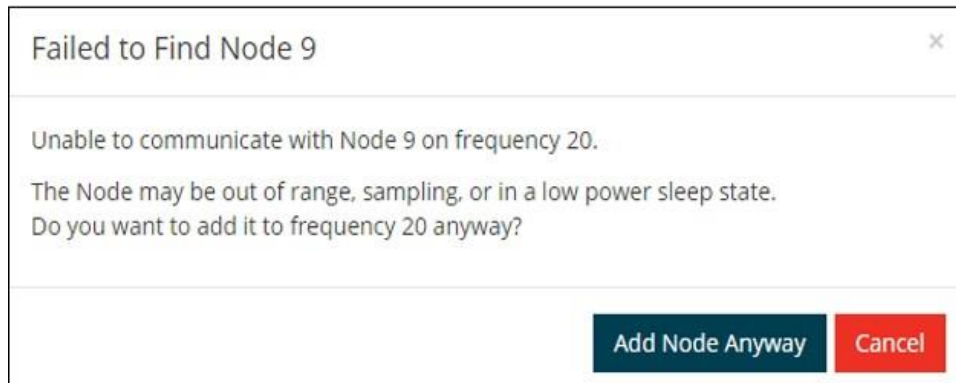

Figure 8 - Failure to Add Node

3.3.3 Move Node To Base Station Frequency

If a red circle with a number appears next to Base Station, the node is operating on a separate radio channel. Select the Base Station and then select the Nodes on Other Frequencies tile.

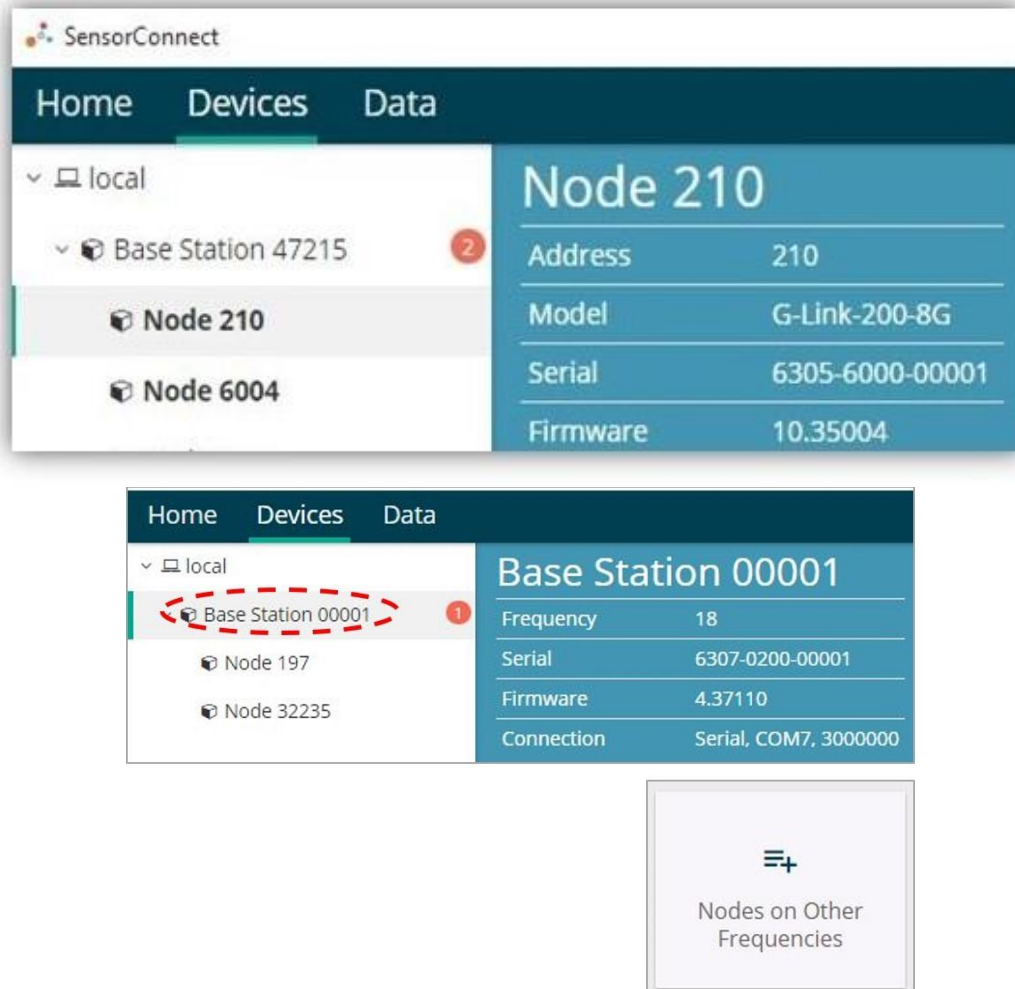

Figure 9 - Nodes On Other Frequencies

Highlight the new node being added and select Move Node to Frequency (#).

Select a Node to move to this BaseStation's frequency.

Node	Frequency	Last Heard
61506	13	6 minutes ago
62884	11	8 minutes ago



 Refresh  Move Node to Frequency 24

Figure 10 - Move Node

4. Wireless Sensor Configuration

4.1 Hardware Configuration

Node settings are stored to non-volatile memory and may be configured using SensorConnect. This chapter describes the user-configurable settings.

The screenshot shows the 'Wireless Node Configuration' interface with four tabs: Hardware, Calibration, Sampling, and Power. The 'Hardware' tab is selected and contains three configuration sections:

- Input Range:** A dropdown menu for 'Input Range' is set to '±2 G's (acceleration)'. The 'Channel(s)' are listed as '1, 2, 3'.
- Low Pass Filter:** A dropdown menu for 'Filter Cutoff' is set to '26 Hz'. The 'Channel(s)' are listed as '1, 2, 3'.
- High Pass Filter:** A dropdown menu for 'Setting' is set to 'Disabled'. The 'Channel(s)' are listed as '1, 2, 3'.

Figure 11 - Node Configuration Menu

- Input Range** - Set the accelerometer range to fit the application. Available ranges are ± 2.048 g, ± 4.096 g, and ± 8.192 g.
- Low Pass Filter and Group Delay** - The accelerometer provides two filter stages for limiting bandwidth and maintaining excellent noise performance. The first stage is an analog, fixed frequency, anti-aliasing filter with -3 dB attenuation at 800 Hz, and 6.18 dB attenuation at 1500 Hz. The second is a user adjustable digital decimation filter. The decimation filter allows low-pass filtering between 26 Hz to 800 Hz on each channel independently. To minimize aliasing, it is recommended that users set the low pass filter to a frequency $\frac{1}{4}$ that of the sample rate or less.

Group Delay is the time delay of the signal amplitude imparted by the low pass filter. *See Table 2 - below* for group delay values corresponding to the low pass filter configuration.

Low Pass Filter (Hz) at -3 dB	Group Delay (ms)
800	0.88
418	1.51
209	2.75
104	5.27
52	10.31
26	20.38

Table 2 - Group Delay

- High Pass Filter** - The accelerometer contains an optional high-pass filter which is disabled by default. The high-pass filter corner frequency is effected by the low pass filter setting. When enabled, the high pass filter -3 dB point will be equal to the corresponding low pass filter value as shown in Table 2 below.

Low Pass Filter (Hz)	Resulting High Pass Filter (Hz)
800	2.48
418	1.24
209	2.48
104	1.24
52	0.62
26	0.31

Table 3 - High Pass Filter Values

4.2 Calibration Configuration

Each node is calibrated at the factory and stores its linear calibration coefficients in nonvolatile memory. These coefficients are applied by the node when the node is outputting data in “floating point” format. The coefficients are applied automatically by SensorConnect when the node is outputting data in signed 16- bit or signed 24- bit formats. For the available data types, the calibration coefficients are applied as follows:

- Float (4 Bytes): Calibration applied by node
- Int24 (3 Bytes): $G\text{-force} = \text{value} * \text{slope} + \text{offset}$
- Int16 (2 Bytes): $G\text{-force} = 64 * \text{value} * \text{slope} + \text{offset}$

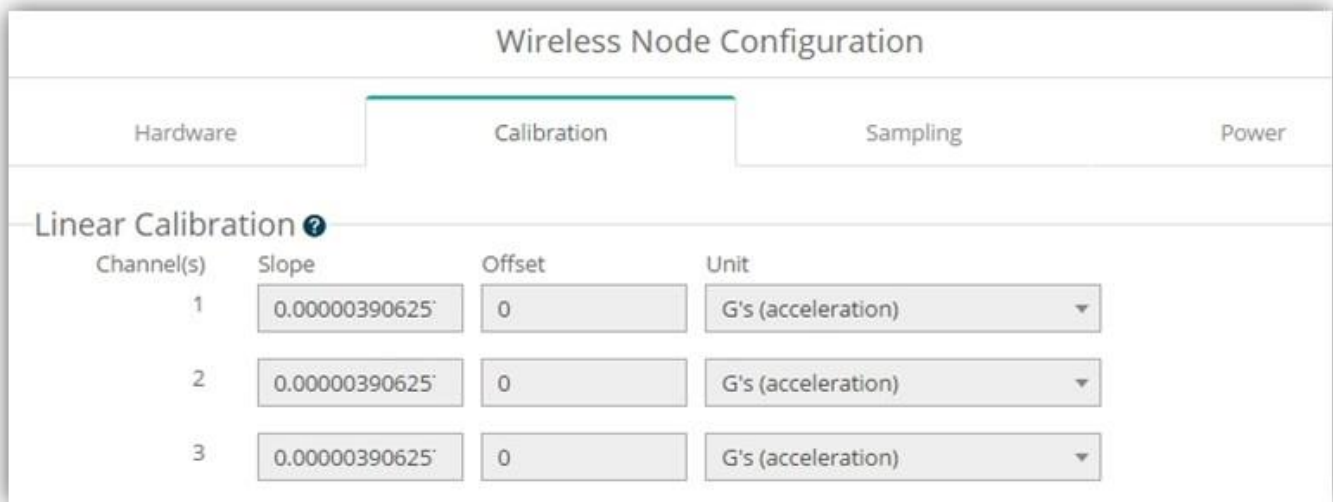

Wireless Node Configuration

Hardware **Calibration** Sampling Power

Linear Calibration ⓘ

Channel(s)	Slope	Offset	Unit
1	0.00000390625	0	G's (acceleration)
2	0.00000390625	0	G's (acceleration)
3	0.00000390625	0	G's (acceleration)

Figure 12 - Wireless Sensor Calibration Menu

4.3 Sampling Configuration

There are three user- set sampling options for the G- Link- 200, including Lost Beacon Timeout, Diagnostic Info Interval, and Storage Limit Mode, in the Wireless Node Configuration > Sampling menu.

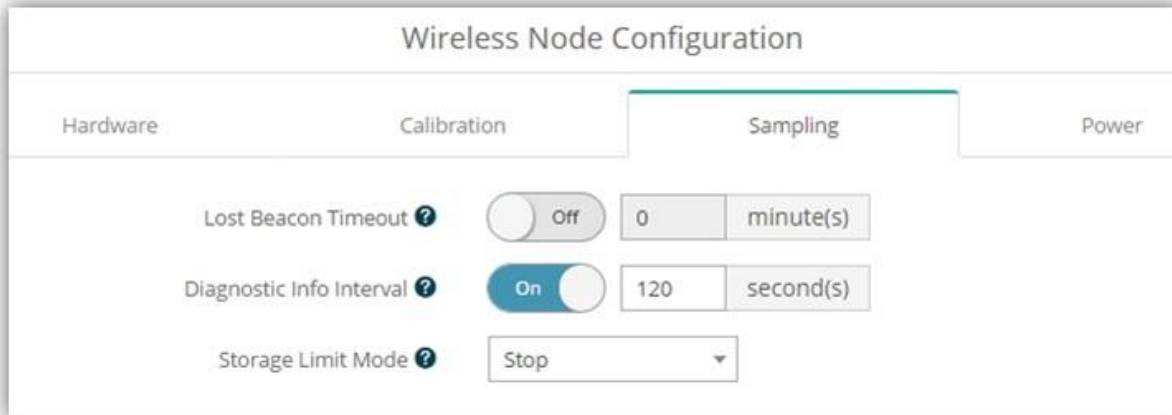

Figure 13 - Sampling Configuration Menu

- **Lost Beacon Timeout** - When the node is running in a synchronized network, it periodically synchronizes its time clock to a beacon broadcasted from the WSDA gateway. The Lost Beacon Timeout feature means that the node will automatically stop sampling and transmitting data after the beacon has been lost for the configured amount of time. The node will save power in this state without user intervention until the beacon returns. Within two minutes of the beacon returning, the node will automatically begin sampling and transmitting data again.
- **Diagnostic Info Interval** - At the defined transmit interval, the wireless sensor will report diagnostic information. The node will continue to transmit this diagnostic information in all operating modes, including Idle, Sleep, and Run modes. ([See Table 4 - below](#)).
- **Storage Limit Mode** - The Storage Limit Mode applies when the node is datalogging to internal flash. The two available options are: 1) **Stop** - when the node fills up its flash memory, it will stop logging data. It is important to erase old data before starting new data logging sessions, and 2) **Overwrite** - when the node fills up its flash memory, new data will overwrite old data in a first-in, first-out method.

The contents of the diagnostic packet may be viewed in the Data tab within SensorConnect.

Description	Data Values	Data Type	Unit
Current State	0 = Idle 1 = Deep sleep 2 = Active run 3 = Inactive run	uint8	--
Run Time	Idle	uint32	seconds
	Deep sleep	uint32	seconds
	Active run	uint32	seconds
	Inactive run	uint32	seconds
Reset Counter	--	uint16	counts
Built in Test Result	0 = no errors	uint32	--
Internal Temperature	Valid range: -40 to 125° C	sint8	Celsius
Low Battery Indicator	0 = good 1 = low 2 = critical (sensor will stop sampling)	uint8	--
External Power	0 = not connected 1 = external power connected	uint8	--
Sample Info	Sweep index	uint32	counts
	Bad sweep count	uint32	counts
Transmission Info	Total transmissions	uint32	counts
	Total retransmissions	uint32	counts
	Total dropped packets	uint32	counts
Synchronization Info	Synchronization attempts	uint32	counts
	Synchronization failures	uint32	counts
	Seconds since last synchronization	uint32	counts
Event Trigger Index	--	uint16	counts

Table 4 - Diagnostic Packet

4.4 Power

There are multiple user-set power options for the G-Link-200, including Default Operation Mode, User Inactivity Timeout, Check Radio Interval, and Transmit Power, in the Wireless Node Configuration > Power menu.

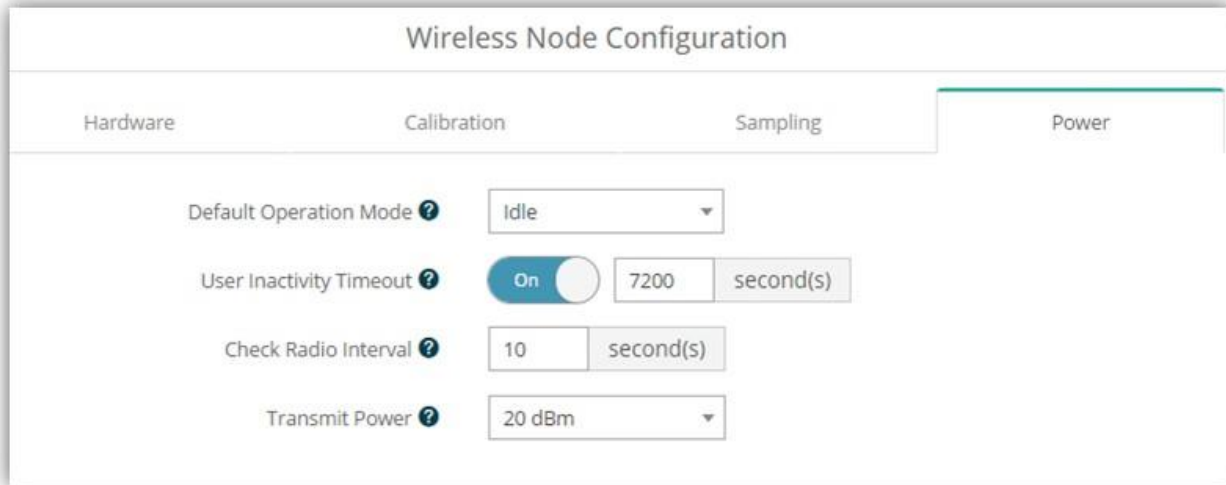

Figure 14 - Node Configuration Power Menu

- **Default Operation Mode** - When power is applied, the node will enter the Default Operation Mode.
- **User Inactivity Timeout** - While in Idle mode, the node will automatically enter Sleep mode if it does not receive any commands for the selected amount of time. If Sample is selected under Default Operation Mode, the node will automatically re-enter the sample mode it performed last with all current settings. Disable User Inactivity Timeout to avoid the node automatically changing states.
- **Check Radio Interval** - While in Sleep and Sample modes, the Check Radio Interval sets the frequency the node checks the radio channel for a "Set to Idle" command. Decreasing the Check Radio Interval will shorten the amount of time it takes to wake the node into Idle mode with the cost of decreasing battery life. Increasing the Check Radio Interval could increase battery life at the cost of increasing the amount of time it takes to wake the node into its Idle mode.
- **Transmit Power** - Set the output power of the radio to a value between 0dBm to +20dBm. The output power will effect communication range and also battery life.

5. Wireless Sensor Sampling Configuration

5.1 Start Collecting Data

There are several ways to collect data from the G-Link-200, including from a single node, a network of nodes, or restarting the last used sampling mode, by pressing and holding the start button until the LED light turns blue.

- Single node** - From Devices, select Node > Sampling > Apply and Start Network to begin collecting data from a single wireless sensor.

Network Settings: <input checked="" type="checkbox"/> Synchronized  <input checked="" type="checkbox"/> Lossless  <input type="checkbox"/> High Capacity 				
<input checked="" type="checkbox"/>	Node	Channels	Sampling	Data Type 
<input checked="" type="checkbox"/>	210	3 Channels 	512 Hz for 0.195 seconds bursting every 60 seconds 	int24 (3 bytes) 

Figure 15 - Single Node Sampling

- Network of Nodes** - From Devices, select > Base Station > Sampling Network > Nodes to be sampled > Apply and Start Network to start collecting data from a network of wireless sensors.

















<input checked="" type="checkbox"/>	Node	Channels	Sampling	Data Type 	Log/Transmit 	% Total	Status
<input checked="" type="checkbox"/>	210	3 Channels 	512 Hz for 0.195 seconds bursting every 60 seconds 	int24 (3 bytes) 	Log 	0.00%	 Ok
<input checked="" type="checkbox"/>	6004						 Failed to Communicate 
<input checked="" type="checkbox"/>	6006						 Failed to Communicate 
<input checked="" type="checkbox"/>	5555	3 Channels 	64 Hz continuously 	float (4 bytes) 	Transmit 	12.50%	 Ok

Figure 16 - Network of Nodes Sampling

- **Button Press** - Press the G-Link-200 Start button and hold until the blue LED turns on, then release the button. The node will enter the most recently used Sampling mode and configuration settings.

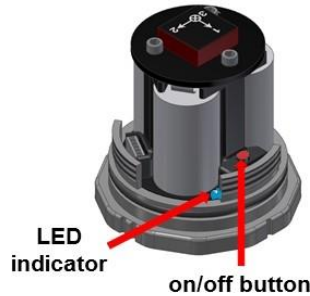

5.2 Network Options

There are three network settings available for the G-Link-200: Synchronized, Lossless and High Capacity.



Figure 17 - Network Settings Menu

- **Synchronized** - By selecting Synchronized, all nodes in the network will periodically synchronize their time clocks to a beacon that is broadcasted by the **WSDA gateway**. Each beacon contains a UTC timestamp, allowing nodes to timestamp their collected data within an accuracy of +/- 50 us.

Each node will also buffer data and transmit this data in time-slots allocated prior to sampling. Using time-slots assures the transmissions will not “collide”, or corrupt each other. It also provides a means for efficiently scaling the size of the network to allow as much data throughput as possible.

If Synchronized is deselected, the node will not require a beacon time source and will transmit a data transmission for each measurement sweep. The user should deselect Synchronized if, either low latency, or the lowest possible power at slow sample rates, is required.

- **Lossless** - The user can achieve near lossless data collection in most environments through the use of data buffering, radio acknowledgments, and retransmissions. Each node buffers collected data and timestamps to an internal 2 Mbit FIFO buffer. For each transmission, data is pulled from this buffer. And upon receiving the data packet, an acknowledgment is sent from the **WSDA gateway** that is providing the beacon. The node will retransmit data until this acknowledgment is received. Inherent overhead in the transmission scheduling protocol assures the node time to recover from periods of poor radio communication.

This feature allows lossless performance in environments where the node achieves as low as 50% packet error rate. It also allows for operation in situations where the gateway and node move in and out of range of each other.

The Lossless feature is only available when Synchronized is enabled. Disable Lossless if the application requires consistent latency or can tolerate lost data.

- **High Capacity** - Enabling high capacity allows larger network sizes and potentially longer battery life, at the cost of increased latency. This is accomplished by decreasing the minimum allowed output rate from 1 transmission per second to 1 transmission every 16 seconds.

5.3 Raw Waveform Channels

There are two options for data output from the G- Link- 200, including raw waveform channels and derived data channels. The raw channels provide waveform data directly from the sensor.



Figure 18 - Raw Data Output

5.4 Derived Output Channels

There are four derived data channels available for the G-Link-200. Using these data channels for vibration analysis allows the ability to extend battery life while reducing data. Each operation is performed on a window of data from the specified accelerometer axis. The timestamp associated with each sweep is that of the last data point collected within that window. The derived data output rate must be at least 32 times slower than the sample rate. (*See Derived Channel Variables on page 29*)

- RMS is calculated by accumulating the mean squared of each chunk, dividing by the number of chunks in the window, and taking the square root.

$$RMS(F) = \sqrt{\sum_{j=0}^{J-1} \frac{\sum_{n=0}^{N-1} F_j(n)^2}{K}}$$

- Crest Factor is calculated by taking the absolute maximum value from the window and dividing by the RMS of the window.

$$CrestFactor(F) = \max(|\max(F_0, \dots, F_{J-1})|, |\min(F_0, \dots, F_{J-1})|) / RMS(F)$$

- Peak to Peak is calculated by subtracting the smallest value from the window from the largest value.

$$PeakToPeak(F) = \max(F_0, \dots, F_{J-1}) - \min(F_0, \dots, F_{J-1})$$

- IPS G-Link-200 Only

The RMS of the IPS is calculated by determining a cubic spline of a chunk, analytically integrating the cubic spline, taking the RMS of the cubic spline integral, and multiplying by 386.2197 to convert from Gs to in/sec².

$$IPS_{RMS}(F) = \sqrt{\sum_{j=0}^{J-1} \frac{\sum_{n=0}^{N-1} (\int CSI(F_j))(n)^2}{K}} \cdot 386.2197$$

Firmware < 10.36231

The RMS of the IPS is calculated by accumulating the mean of the squares of the integral of the chunk, dividing by the number of chunks in the window, taking the square root, and multiplying by 386.2197 to convert from Gs to in/sec².

$$IPS_{RMS}(F) = \sqrt{\sum_{j=0}^{J-1} \frac{\sum_{k=0}^{N-1} |\mathcal{F}[F_j](k) \frac{1}{\omega_k^i}|^2}{N \cdot K}} \cdot 386.2197$$

Name	Description
F	Window of sampled data
F_j	Chunk of sampled data
J	Number of chunks in the window
K	Number of samples in the window
N	Number of samples in the chunk

Table 5 - Derived Channel Variables

5.4.1 Windows

When performing a derived calculation on sampled data a window is used to provide a rate to transmit derived calculations and a range of time to derive from. The length of a window in time is a single period of the derived rate and is given the timestamp of the first sample of the next window.

Given a sample with a timestamp of t and a derived period of p , the timestamp of the derived window it belongs to is defined below.

$$t_{window} = t - (t \bmod p) + p$$

- Burst Mode - when the node is bursting, the window covers the entire burst instead of the derived rate. Given a sample with a timestamp of t , a burst period of p , and a burst duration of d , the timestamp of the derived window it belongs to is defined below.

$$t_{window} = t - (t \bmod p) + d$$

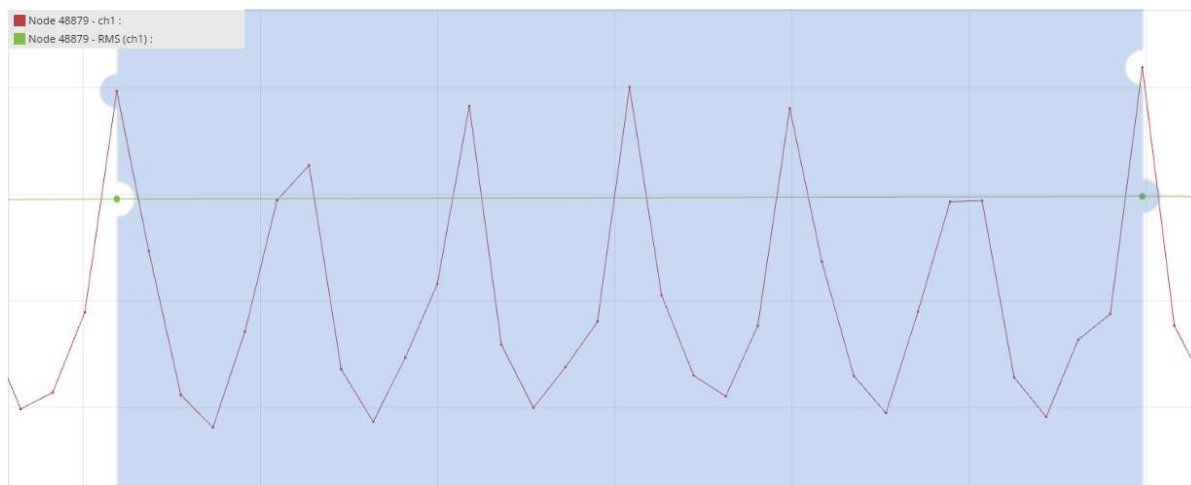

Figure 19 - Derived Data Window

NOTE

A window must contain at least 32 samples. For continuous this means that the derived period must be at least 32 times as long as the sample period. Burst is not limited by this restriction because the minimum burst size is 100 samples.

5.4.2 Chunks

Windows can encompass thousands of samples, but a node can only operate on a finite number of samples at a time, so the node chunks up data to run derived calculations. Chunk size is defined below where p is the derived period, d is the burst duration, and s_{max} is the maximum chunk size. Maximum chunk size can change between nodes depending on how many resources are available for derived calculations. The G-Link-200 has a max chunk size of 256 samples.

Continuous $s_{chunk} = \min(p, s_{max})$

Burst $s_{chunk} = \min(d, s_{max})$

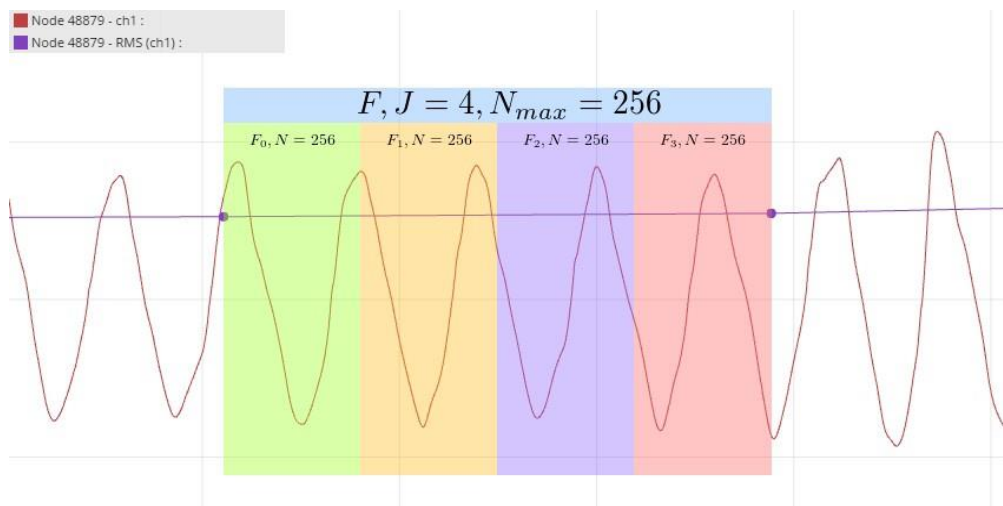

Figure 20 - Derived Data Chunks

5.4.3 Under-sampling

Under-sampling happens when there are not enough samples to accurately calculate a value for a derived channel. The user should pick a window size that contains at least two periods of the lowest rate input signal to be measured. The more information that can be included in the derived calculation the more accurate the calculation will be.

For derived channels that use Fourier transforms on raw data, such as IPS, the chunk size will limit the input frequency range rather than the window size. If the chunk size is at its maximum size the only way to gain accuracy for lower frequencies is to reduce the sample rate.

5.4.4 Incoherence

Derived channels are most accurate when the window time is a multiple of the period of the input signal, meaning that the window is coherent with the input signal. When the window is not coherent with the input signal, the window will end up with a fraction of a period of the input signal at the end, which will skew the derived calculation for the window in some cases. Inaccurate derived values due to incoherence can be mitigated by using a larger window size. The more input signal periods sampled within a window the more accurate the calculation will be.

5.5 Sampling Operations Options

There are four sampling operations options for the G-Link-200, including Continuous, Limited, Periodic Burst, and Event Triggered.

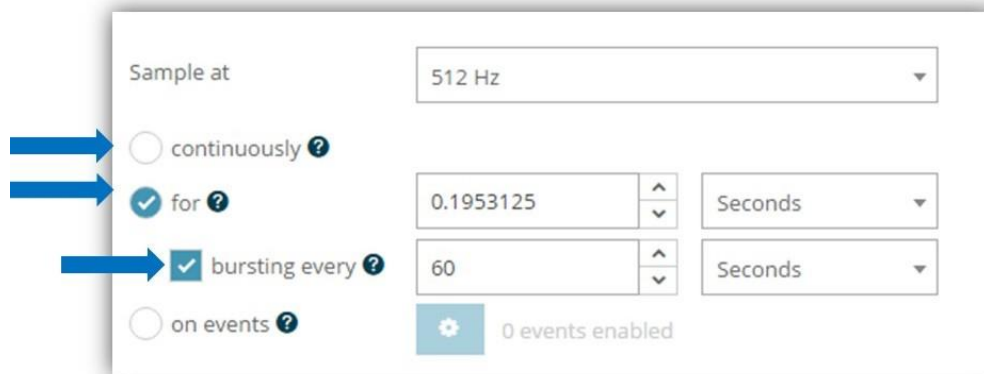

Figure 21 - Sampling Operations Menu

- **Continuous** - Collect data continuously at the configured sample rate. All data is transmitted and/or logged to flash memory until a Set to Idle command is received.
- **Limited** - Automatically stop sampling and return to Idle mode after the configured time duration is met.
- **Periodic Burst** - Perform short sampling bursts at periodic intervals. This operation allows longer battery life and increased network sizes in applications where continuous monitoring is not required.

- **Event Triggered** - Collect data continuously at a fixed sample rate. However, only transmit and/or log the data if one of the configured threshold conditions has been met. When the condition is met, all active sensor channels will transmit and/or log both pre- and post-event data. The benefits of this operation mode include increased battery life, reduced data sets, and increased network size.

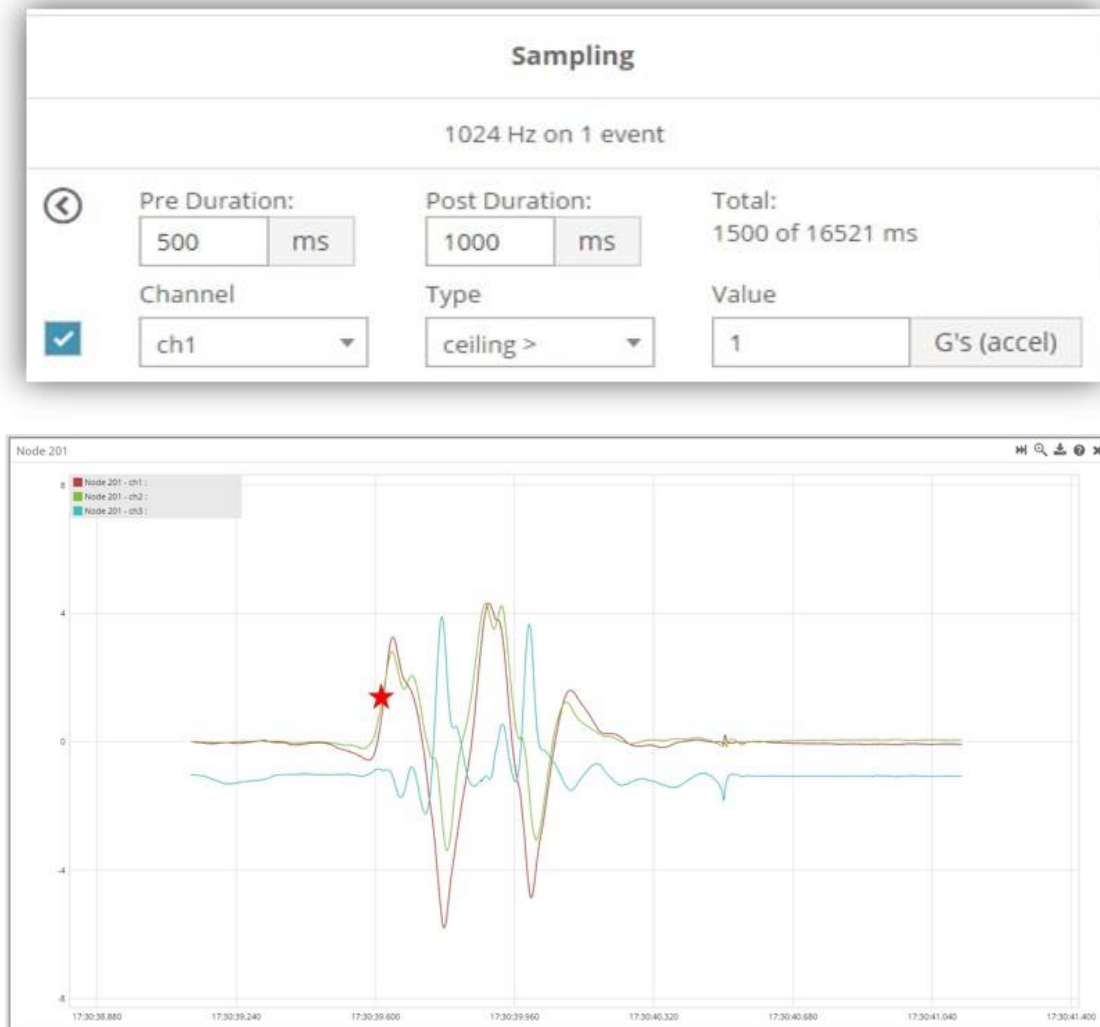

Figure 22 - Event Triggered Sampling

5.6 Data Type

There is a 20-bit ADC on the G-Link-200. However, users may select the data type that is reported. Floating point should be selected in most applications and where nodes must send measurements in units of g-force. Int16 or Int24 may be selected for applications requiring maximum network bandwidth or longer battery life.

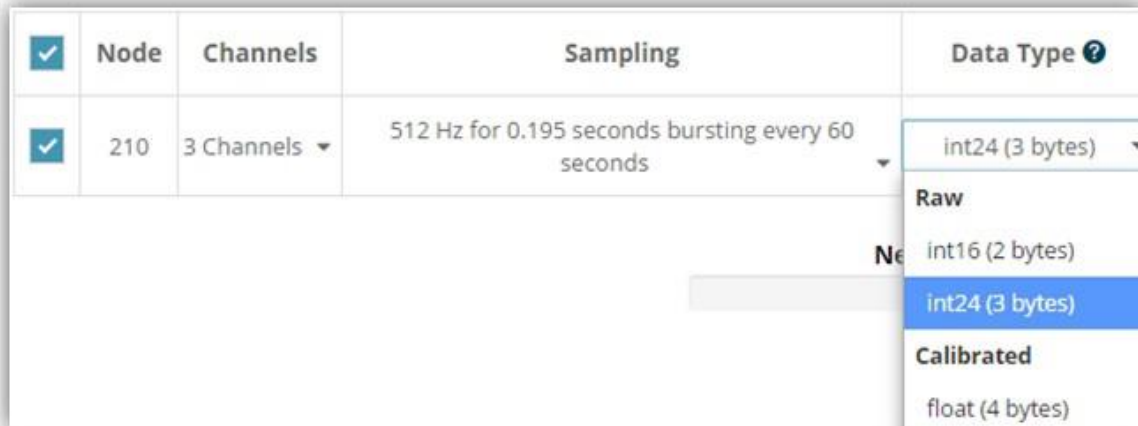

Figure 23 - Data Type Menu

- Float (4 Bytes)** - The node applies calibration coefficients locally and reports measurements as floating point values.
- Int24 (3 Bytes)** - The node sends its 20-bit measurements as signed 24-bit values. Data collection software such as **SensorConnect** must apply the calibration coefficients using the following equation:

$$\text{G-force} = \text{value} * \text{slope} + \text{offset}$$

- Int16 (2 Bytes)** - The node sends its 20-bit measurements as signed 16-bit values. Data collection software such as **SensorConnect** must apply the calibration coefficients using the following equation:

$$\text{G-force} = \text{value} * 64 * \text{slope} + \text{offset}$$

5.7 Output Operation

There are three options for managing data acquired from the G-Link- 200. The user can transmit collected data, log the data to flash memory, or do both.

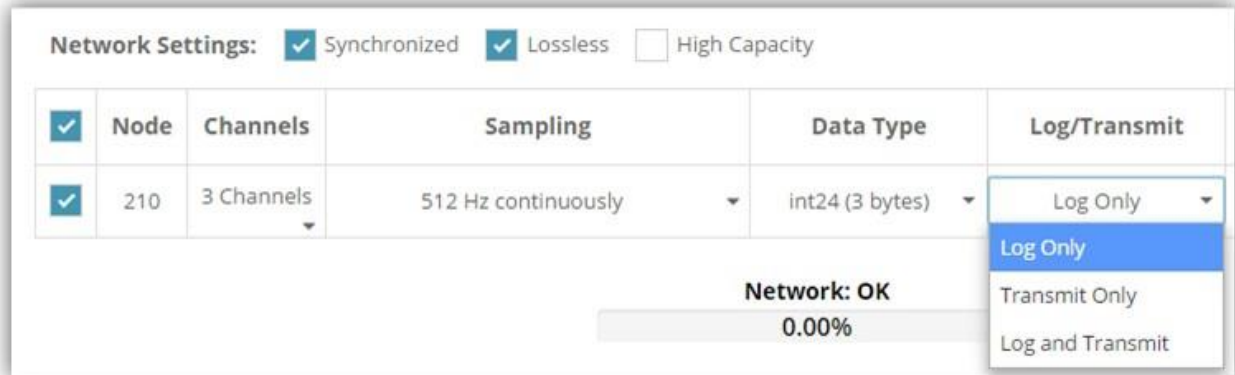

Figure 24 - Data Outputs

6. Viewing Data

6.1 SensorCloud

Data acquired through SensorConnect is automatically saved on the host computer. Saved data can be uploaded to SensorCloud. Ethernet gateways provide the option to automatically port the data to SensorCloud during data acquisition for near real-time display and aggregation. Ethernet gateways can also be configured to save data locally to internal memory for future upload to the host computer or SensorCloud.

SensorCloud is based on cloud computing technology and is designed for long term collecting and preservation of data. Features include time series and visualization graphing, automated alerts, and data interpretation tools such as data filtering, statistical analysis, and advanced algorithm development with the integrated MathEngine[®] interface. Leveraging the open source API, SensorCloud can also be used to collect data from other LORD Sensing sensor products or third-party systems. Basic SensorCloud services are available to all users free of charge at: <http://www.sensorcloud.com/>.

6.1.1 Connect to SensorCloud

Go to the SensorCloud website and select sign-in to enter the log-in credentials, or register as a new user if needed.

<http://www.sensorcloud.com/>

Figure 25 - SensorCloud Log-in or Register

6.1.2 Navigating Menus

The SensorCloud interface has **six main views**. When logging in as a registered user, the Device view is the default. Navigate to other views by clicking the view name at the top of the page (*Figure 26 - SensorCloud Menu Views*). The Data and Settings views are only available once a device is selected from the device list.

SensorCloud						
DEVICES ACCOUNT CSV UPLOADER DATA SETTINGS MATHENGINE®						
LOG OUT						
Device lists – select a device to access Data and Settings menus						
Owned Devices						
DEVICE	MAN	CONFIGURATION	LAST HEARD FROM	DATA (JUN 18 - JUL 18)	TOTAL STORAGE	
Row Device 0AF102258C9F769H	Basic LOCKED	Configuration		Usage Transactions: 0.00K/25K Monthly Storage: 0.00/10 MDP	0.00 MDP	
W063140205021034	Basic LOCKED	Configuration	7/21/14 11:30	Usage Transactions: 0.00K/25K Monthly Storage: 0.00/10 MDP	1.88 MDP	
Add Device						
Shared Devices						
DEVICE	MAN	CONFIGURATION	LAST HEARD FROM			
M5Test (study) FFR0013C91C7AB0		Configuration	7/15/15 12:02			
CallFax - Heavy Loading Run Up 9-4-13 0AF102258C9F769H		Configuration				
Demo Devices						
DEVICE	MAN	CONFIGURATION	LAST HEARD FROM			
Demo Structure 0AF102258C9F769H		Configuration	7/14/15 14:36			

Figure 26 - SensorCloud Menu Views

Device - The device list shows every Ethernet gateway and API device associated with the SensorCloud account, including owned, shared, and demo devices. This view provides links to each device's SensorCloud subscription plan, configuration options, and a summary of last communications and data transactions.

Account - The account view is for logistic management of the SensorCloud account, such as changing the log-in password, accessing user email, and reviewing billing information.

CSV Uploader - The data upload feature enables data from any source (such as non-Ethernet LORD Sensing gateways, or third-party sensor) to be uploaded to the SensorCloud platform. The data must be in the LORD Sensing CSV format.

Data - This view is only available after a device is selected. It displays data that is collected from sensor nodes or uploaded from files. Data selections are listed by node channel or a user-defined label and can be enabled for display in the graph window. The interactive graph has navigational features such as panning, zooming, and an overview graph for single-click access to data points or ranges. There are also use and management features such as viewing the meta-data and downloading, embedding, and tagging data graphs.



Figure 27 - SensorCloud Data View

Settings - The settings view provides options for adding meta-data, configuring the data displays for each channel, creating alerts based on data thresholds, setting the data timezone, and more.

MathEngine[®] - is used to analyze sensor data. Functions include the ability to filter out frequencies, smooth out noisy data, perform math operations such as Fast Fourier Transforms (FFTs), and more. MathEngine[®] interfaces with the SensorCloud graphing view for faster processing. Users can write their own algorithms for custom applications. Refer to the MathEngine[®] website for more information.

<http://sensorcloud.com/mathengine>

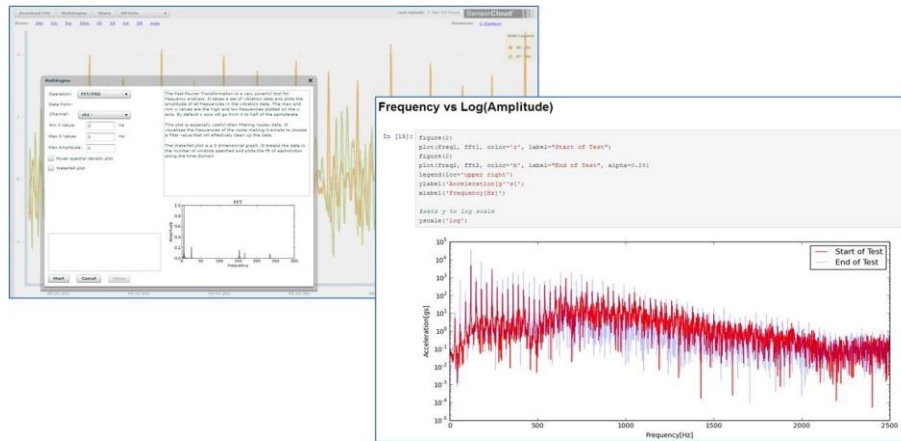

Figure 28 - MathEngine[®] View

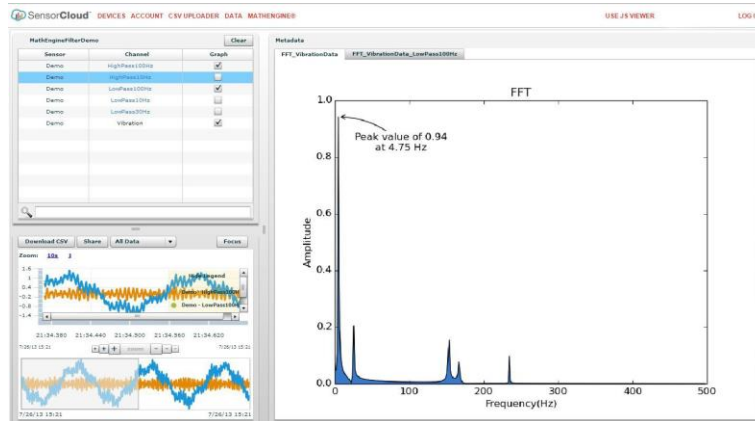

Figure 29 - FFT Graph in SensorCloud

For more information about SensorCloud features and navigation, refer to the SensorCloud website or contact LORD Sensing Technical Support.

<http://www.sensorcloud.com/>

6.2 SensorConnect

6.2.1 Using Dashboards and Widgets

Collected data is viewed on the Data page through the creation of dashboards and widgets. Think of dashboards as individual pages and widgets as an illustration on the page. Create multiple data widgets on each dashboard to display sampled data as a time-series graph, text chart, or a simple gauge that only displays the most current reading. This format provides an easy way to organize many sensors and networks, and it allows the information to be displayed in the most appropriate layout.

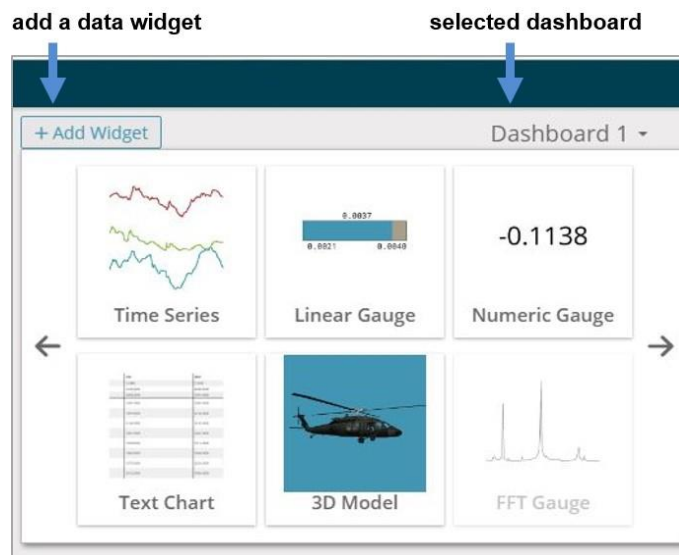

Figure 30 - Viewing Data

6.2.2 Navigating Graphs

Use the mouse along with the shift and control keys inside the graph window to adjust the data view.

Control	Action
Mouse wheel	Zoom in/out on <i>x</i> -axis
Shift + mouse wheel	Zoom in/out on <i>y</i> -axis
Mouse double-click	Zoom to extends
Shift + mouse left-click and drag left/right	Zoom window left/right
Shift + mouse left-click and drag up/down	Zoom window up/down
Ctrl + mouse left-click and drag	Zoom box

Table 6 - Graph View Controls

6.2.3 Widgets Options

The widget configuration menu is different for each type of widget but typically includes sensor or channel selections and widget settings such as titles and legends.

After adding a widget, left click to select and configure it in the Channels and Settings left sidebar menu. Under Channels, the channel(s) for the widget can be enabled and disabled.



Figure 31 - Widget Settings Menu

6.2.4 Time Series Widget Menu

The Time Series Widget menu has two features to help optimize sensor data collection for export to a .csv file. *Snap to Latest* captures the most recent data and *Zoom* isolates specific events from a larger data sample (see [Exporting Data Files on page 42.](#))



Figure 32 - Time Series Widget Menu

6.2.5 Exporting Data Files

To export data to a .csv file, select the Export Data button on the Time Series widget > Export > name the document > save to the preferred location on the host computer.

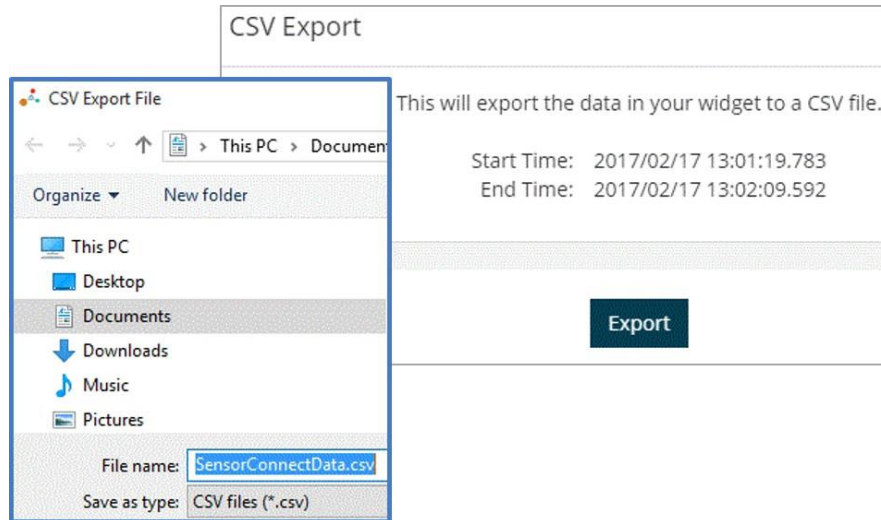

Figure 33 - Exporting Data

7. Installation

7.1 Mounting Recommendations

The G-Link-200 is rated for IP67 environmental protection from water and dust and can be used in many indoor and outdoor applications. .

There is one ¼ - 28 UNF - 2B mounting hole on the base of the G-Link-200. For proper coupling of the accelerometer to the substrate being measured, use the mounting hole and a screw to fasten the node to a rigid surface. This will reduce higher frequency losses.

The node can be mounted in any orientation, but it is recommended that it is mounted in a way that optimizes wireless communications. For more information, [see *Optimizing the Radio Link on page 45.*](#)

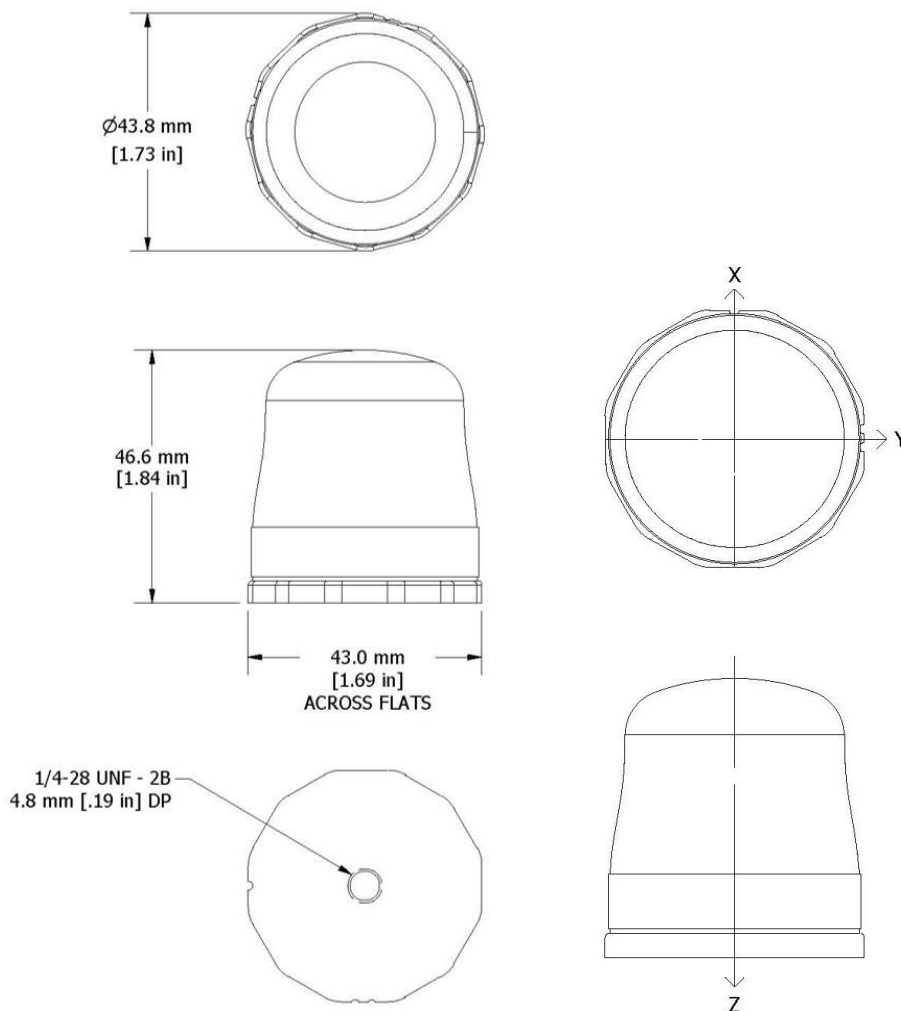

Figure 34 - Mounting the Node

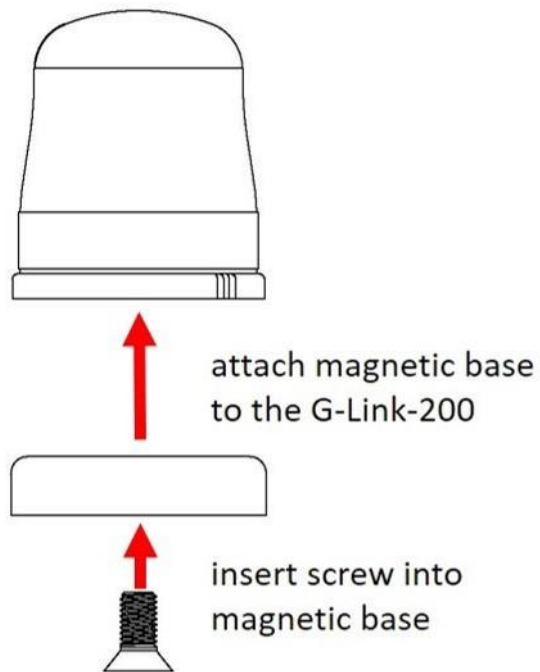

Figure 35 - Installing The Magnetic Base

7.2 Optimizing the Radio Link

NOTE

In the event of communication difficulties, it may be necessary to disable WIFI on the host computer, or use a USB extender when collecting data.

The best method for ensuring optimal radio communication is to conduct an RF survey of the installation site. This is easily accomplished in SensorConnect by using the range test feature to quantify the radio signal strength (RSSI) in various scenarios. [See Range Test on page 46](#) for instructions on using SensorConnect for measuring RSSI. The following are general guidelines for maximizing communication range:

- ▮ **Line of Sight (LOS)** between the node and gateway. Try to avoid obstructions such as buildings, terrain, vegetation, or other physical barriers.
- ▮ **Increase the Mounting Height** of the node to allow a clearer LOS path to the gateway. Height above the ground is also important because reflections off of the ground can interfere at the receiver. Generally, the higher above the ground the better.
- ▮ **Minimize Radio Frequency Interference (RFI)** from other wireless devices, especially those operating in the same frequency range. This includes other nodes and 2.4 GHz WIFI routers. If other wireless devices are required nearby, mount them at different heights to minimize interference. Additionally, a different radio frequency may be selected using SensorConnect software.
- ▮ **Minimize Electromagnetic Interference (EMI)** such as that which is generated by power transmission equipment, microwaves, power supplies, and other electromagnetic sources.
- ▮ **Metal Objects** in close proximity to either antenna, particularly ferrous metals such as steel and iron, can be problematic for wireless communications. The larger the object, the greater the influence.

7.2.1 Range Test

After establishing communication between node and gateway, use the range test feature in SensorConnect to monitor the signal strength and to optimally position the nodes, gateway, and antennae for installation. Maximum achievable range is determined by the gateway and node power settings (found in the device Configure menu) and is highly dependent on the physical environment surrounding the devices.

1. Select the node name > Range Test

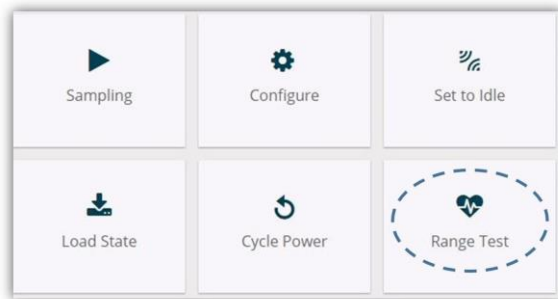

Figure 36 - Range Test Menu

2. RSSI is a measure of signal strength between the node and the base station. A higher RSSI value (closer to zero), will result in better node to base station communication. Reliable communication can be achieved with a signal strength greater than -75 dBm, in the absence of radio frequency interference. Position the node and gateway antennas where the best RSSI value is observed.

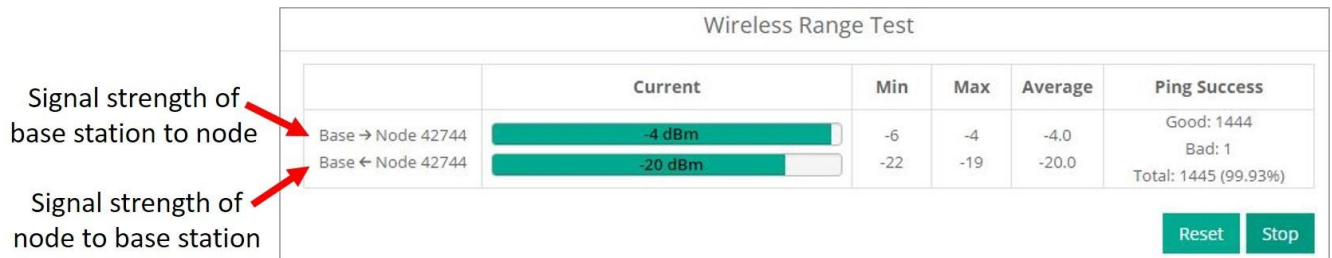
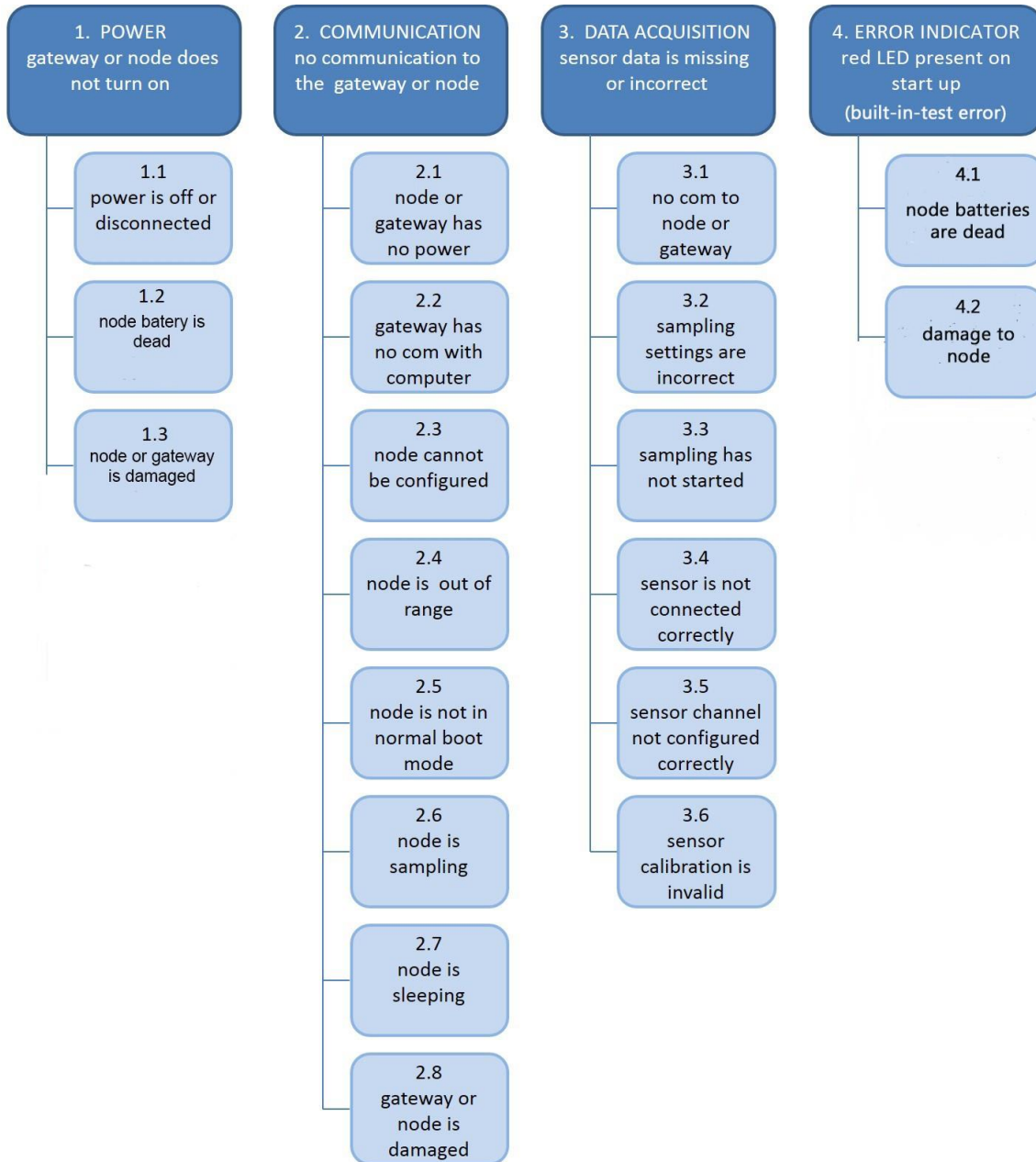

Figure 37 - Range Test Statistics

8. Troubleshooting

8.1 Troubleshooting Guide



	Possible cause and recommended solution
1. POWER gateway or node does not turn on	1.1 node or gateway power is off The status indicator LED on the device may be off. Turn the device on, and the status indicator LED should illuminate.
	1.2 node battery is dead If the node will not power on, the node battery may need to be replaced.
	1.3 node or gateway is damaged If all power settings and connections have been verified, and the node is still unresponsive, contact LORD Sensing Technical Support (See Technical Support on page 67).
2. COMMUNICATION no communication to the gateway or node	2.1 node or gateway has no power Verify the node and gateway have power applied and that applicable power switches are on. Power is indicated on both devices by a status indicator LED.
	2.2 gateway has no communication with the computer Verify gateway communication in the software. Check, remove, and reconnect communications and power cables as applicable.
	2.3 node cannot be configured Observe the node status indicator LED to determine the device's state: boot, idle, sample, or sleep. If the node is sampling or sleeping, it cannot be configured. In , execute the Set to Idle command to put the node in idle state, allowing configuration to occur. If the user inactivity timeout is set very low, the configuration menu will have to be entered quickly, before the timeout occurs, putting the node back in a sample or sleep state.
	2.4 node is out of range Perform a bench test with the node in close proximity to the gateway to verify they are operational. For range test and installation recommendations The system has been tested to operate with the node and gateway up to 2 km apart with clear line of sight.
	2.5 node is not in normal boot mode If the node status indicator shows the node booting in a mode other than the normal boot mode, it can be bypassed by cycling the node power rapidly three times, then leaving it on for normal power up. In normal boot mode the communication can be established with automatic node discovery (or manually) once the boot process is complete and the node is in idle state. Start-up mode can then be changed in the software.
	2.6 node is sampling Observe the node status indicator LED to determine the

	Possible cause and recommended solution
	<p>device's state: boot, idle, active, or sleep. If the node is sampling, it cannot be configured. In , execute the Set to Idle command to put the node in idle state, allowing configuration to occur.</p>
	<p>2.7 node is sleeping</p> <p>Observe the node status indicator LED to determine what state it is: boot, idle, active, or sleep. If the node is sleeping, it cannot be configured. In , execute the Set to Idle command to put the node in idle state, allowing configuration to occur.</p>
	<p>2.8 gateway or node is damaged</p> <p>Verify all connections, power, and settings. If available, try installing alternate nodes and gateways one at a time to see if the faulty device can be identified. If no conclusion can be determined or to send a device in for repair, contact LORD Sensing Technical Support (See Technical Support on page 61).</p>
<p>3. DATA ACQUISITION</p> <p>sensor data is missing or incorrect</p>	<p>3.1 no communication to node or gateway</p> <p>Verify connections and power to the node and gateway. Verify they are powered on and communicating with the software. Enter a configuration menu to verify that the node can be accessed.</p>
	<p>3.2 sampling settings are incorrect</p> <p>If the sampling mode, rate, or duration are not performing as expected, enter the node configuration menu, and verify the sampling settings.</p>
	<p>3.3 sampling has not started</p> <p>If sampling is occurring, the sampling mode will be displayed next to the node name in . The node device status indicator will also be flashing the sampling mode code. If the node is not sampling, activate it in the software or with a sample on start up boot sequence.</p>
	<p>3.4 sensor is not connected correctly</p> <p>Verify sensors connections and wiring.</p>
	<p>3.5 sensor channel not configured correctly</p> <p>Verify that the sensor is configured on the correct channel and has been enabled for data acquisition.</p>
	<p>3.6 sensor calibration is invalid</p> <p>Internal sensors are factory calibrated and should not need adjustment. The calibration data is provided with the sensor when purchased.</p>
	<p>4.1 node batteries are dead</p> <p>Remove the batteries for more than 10 seconds, and re-insert,</p>

	Possible cause and recommended solution
4. ERROR INDICATOR Red LED present on start up	if Red LED persists, replace with 3 new batteries.
	4.2 damage to the node If Red LED persists after replacing the batteries, there is damage to the node. Contact LORD Sensing Technical Support for assistance (<i>see Technical Support on page 61</i>).

8.2 Updating Node Firmware

Under the recommendation of LORD Sensing Technical Support Engineers, nodes can be upgraded to the latest available firmware to take advantage of new features or correct operating issues. ~~SensorConnect~~ version 5.0.0 or greater can be used to update any mXRS or LXRS node or gateway firmware to the most current version. Updates are found on the LORD Sensing website. [See Technical Support on page 61](#) for contact and website information.

1. Download the Firmware Upgrade file from the LORD Sensing website.
2. Once downloaded, extract the contents of the .zip file into a folder on the computer. Verify there is a file with a .zhex extension.
3. Launch SensorConnect, and establish communication between the node and gateway as normal.
4. Select the Node address > Upgrade Firmware > select Browse > select the Firmware Upgrade file > Start Upgrade

Figure 38 - Update Node Firmware

8.3 Repair and Calibration



General Instructions

In order to return any LORD Sensing product, you must contact LORD Sensing Sales or Technical Support to obtain a Return Merchandise Authorization number (RMA). All returned merchandise must be in the original packaging including manuals, accessories, cables, etc. with the RMA number clearly printed on the outside of the package. Removable batteries should be removed and packaged in separate protective wrapping. Please provide the LORD Sensing model number and serial number as well as your name, organization, shipping address, telephone number, and email. Normal turn-around for RMA items is seven days from receipt of item by LORD Sensing.



Warranty Repairs

LORD Sensing warrants its products to be free from defective material and workmanship for a period of one (1) year from the original date of purchase. LORD Sensing will repair or replace, at its discretion, a defective product if returned to LORD Sensing within the warranty period. This warranty does not extend to any LORD Sensing products which have been subject to misuse, alteration, neglect, accident, incorrect wiring, mis-programming, or use in violation of operating instructions furnished by us. It also does not extend to any units altered or repaired for warranty defect by anyone other than LORD Sensing.



Non-Warranty Repairs

All non-warranty repairs/replacements include a minimum charge. If the repair/replacement charge exceeds the minimum, LORD Sensing will contact the customer for approval to proceed beyond the minimum with the repair/replacement.

9. Parts and Configurations

9.1 Node Accessories

The following parts are available for use with the G-Link-200. For the most current product information, custom, and OEM options not listed below, refer to the LORD Sensing website or contact the LORD Sensing Sales Department [See Product Ordering on page 62](#)

Description	LORD Sensing Part Number
3.6 V ½ AA lithium battery (Saft LS 14250)	9021-0040
Magnetic mounting base	6306-1020
¼ 28 Flat head mounting screw	
Washer, magnetic (1 pack)	6306-1021
Washer, magnetic (5 pack)	6036-1022

Table 7 - Node Accessories

9.2 Wireless System Equipment

The following system parts are available for use with the G-Link-200. For the most current standard, custom, and OEM product options, refer to the LORD Sensing website or contact the LORD Sensing Sales Department.

Model	Description	LORD Sensing Part Number
--	SensorConnect Software	8220-0023
--	SensorCloud Software Subscription (contact LORD Sensing Sales)	6600-0001
--	Replacement USB cable	9022-0029
WSDA-1500	Ethernet Data Gateway	6314-1500
WSDA-BASE-104	USB Gateway	6307-1040
WSDA-BASE-101	Analog Output Gateway	6307-1010

Table 8 - Wireless System Equipment

10. Specifications

10.1 Physical Specifications

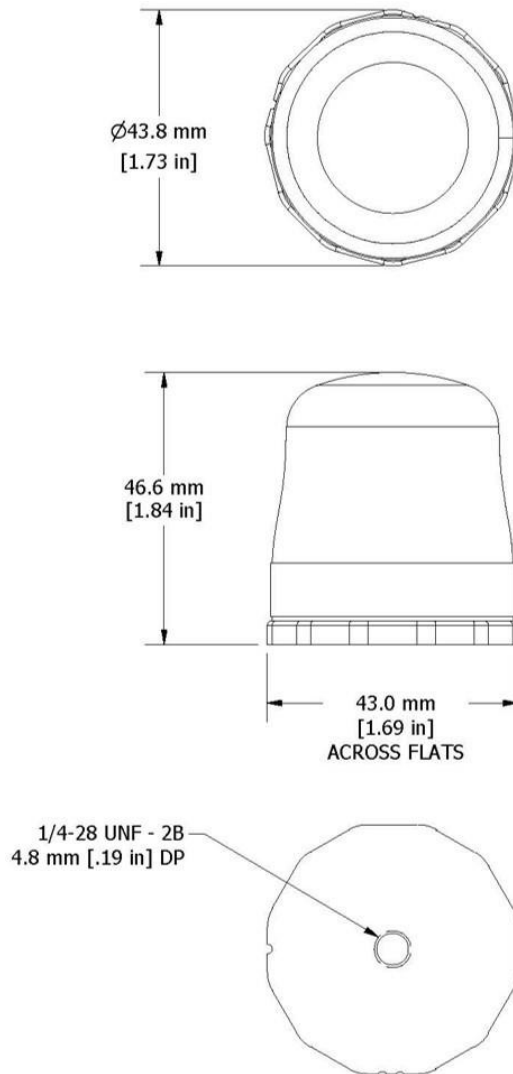

Dimensions: 46.6 mm x 43 mm x 44 mm
Mounting: $1/4 - 28 \text{ UNF} - 2\text{B}$ 4.8 mm [.19 in] DP.
Weight: With 3 batteries: 122 grams
Enclosure Environmental Rating: IP67

10.2 Operating Specifications

Parameter	Specifications	
Accelerometer Channels		
	8 g	40 g
Measurement range	$\pm 2 g, \pm 4 g, \text{ or } \pm 8 g$ configurable	$\pm 10 g, \pm 20 g, \text{ or } \pm 40 g$ configurable
Noise density	$25 \mu g/\sqrt{Hz}$	$80 \mu g/\sqrt{Hz}$
0 g offset	$\pm 25 \text{ mg } (\pm 2 g)$	$\pm 50 \text{ mg } (\pm 10 g)$
0 g offset vs temperature	$\pm 1 \text{ mg/ } ^\circ\text{C}$ (typical), $\pm 15 \text{ mg/ } ^\circ\text{C}$ (maximum)	$\pm 0.5 \text{ mg/ } ^\circ\text{C}$ (typical), $\pm 0.75 \text{ mg/ } ^\circ\text{C}$ (maximum)
Integrated Sensors	Triaxial MEMS accelerometer, 3 channels	
Accelerometer bandwidth	DC to 1 kHz	
Resolution	20-bit	
Scale factor error	< 1% full-scale	
Cross axis sensitivity	1%	
Sensitivity change (temperature)	$\pm 0.01\%/^\circ\text{C}$	
Anti-aliasing filter	1.5 kHz (-6 dB attenuation)	
Low-pass digital filter	26 to 800 Hz - configurable	
High-pass digital filter	Off to 2.5 Hz - configurable	
Integrated Temperature Channel		
Measurement range	- 40 °C to 85 °C	
Accuracy	$\pm 0.1 \text{ } ^\circ\text{C}$ (over full range)	
Sampling		
Sampling modes	Continuous, periodic burst, event triggered	
Output options	Acceleration, Derived channels: Velocity (IPS_{rms}), Amplitude (G_{rms} and G_{pk-pk}) and Crest Factor	
Sampling rates	1 sample/hour to 4096 samples/second	
Sample rate stability	$\pm 5 \text{ ppm}$	
Network capacity	Up to 128 nodes per RF channel (bandwidth calculator:) http://www.microstrain.com/configure-your-system	
Node synchronization	$\pm 50 \mu\text{sec}$	
Data storage capacity	16 M Bytes (up to 8,000,000 data points)	
Operating Parameters		
Wireless communication range	Outdoor/line-of-sight: 2 km (ideal)*, 800 m (typical)**, Indoor/obstructions: 50 m (typical)**	
Radio frequency (RF) transceiver carrier	License-free 2.405 to 2.480 GHz with 16 channels	
RF transmit power	User-adjustable from 0 dBm to 20 dBm. Power output restricted regionally to operate within legal limits	
Power source	3 x 3.6 V, ½ AA batteries (Saft LS 14250 recommended) 3.3 -5.5V dc to solder pads	
Battery input range	0.8 V to 5.5 V	
Operating temperature	-40 °C to +85 °C	
Physical Specifications		
Dimensions	46.6 mm x 43 mm x 44 mm 38 mm x 28 mm	
Mounting	¼ - 28 UNF - 2B 4.8 mm [.19 in] DP. (4) 2- 56 UNC	
Weight	Node with 3 batteries: 122 grams TBD	
Environmental rating	IP67	

Parameter	Specifications
Enclosure material	300 series stainless steel with polycarbonate cover
Conformal coating	TBD
Integration	
Compatible gateways	All WSDA base stations and gateways
Software	SensorCloud, SensorConnect, Windows 7, 8 & 10 compatible
Software development kit (SDK)	http://www.microstrain.com/software/mscl
Regulatory compliance	FCC (USA), IC (Canada), CE (European Union), JET (Japan)

*Actual range varies with conditions

**Measured with antennas elevated, no obstructions, no RF interferers.

11. Safety Information

This section provides a summary of general safety precautions that must be understood and applied during operation and maintenance of components in the LORD Sensing Wireless Sensor Network. Throughout the manual, ANSI Z535 standard safety symbols are used to indicate a process or component that requires cautionary measures.

11.1 Powering the Node

The node is powered by three non-rechargeable, replaceable 3.6 V dc, 1.2 Ah, ½ AA lithium batteries. If the node will not power, the batteries may need to be replaced.

Node battery life is highly dependent on the operational parameters such as sample mode and ~~rate~~ active channels and higher sample rates equate to decreased battery life.



The G-Link-200 contains internal, non-rechargeable lithium batteries. When replacing batteries, use only the batteries specified for the node. Do not disassemble, short circuit, crush, puncture, or otherwise misuse the battery. Do not attempt to recharge the batteries. Do not expose to water. Disposal is subject to federal and local laws.

11.2 Replacing Batteries

1. Remove the cap from the G-Link-200.
2. Remove the three ½ AA batteries from the G-Link-200.
3. Insert three new ½ AA batteries (Saft LS 14250 recommended), observing the correct polarity orientation. The positive polarities are indicated on the batteries and the node by a "+" symbol.
4. Replace the cap.

11.3 Battery Hazards

⚠ WARNING **⚠ CAUTION** **NOTICE**



Lithium batteries contain toxic chemicals that are harmful to humans and the environment. Disposal is subject to federal and local laws. Do not discard the battery or the node in the trash. Follow proper battery disposal protocol, or contact LORD Sensing Technical Support for information on extracting the battery or returning the product for proper recycling and disposal.

11.4 Disposal and Recycling

⚠ WARNING **⚠ CAUTION** **NOTICE**



The G- Link[®] - 200 contains internal batteries, printed circuit boards, and electronic components. These items are known to contain toxic chemicals and heavy metals that are harmful to humans health and the environment. Disposal is subject to federal and local laws. Do not discard the device or batteries in the trash. Follow proper electronic and battery waste disposal protocol, as dictated by federal and local authorities. Some states have programs for extracting reusable parts for recycling.

11.5 Radio Specifications

The G- Link- 200 employs a 2.4GHz IEEE 802.15.4- compliant radio transceiver for wireless communication. The radio is a direct- sequence spread spectrum radio and can be configured to operate on 14 separate frequencies ranging from 2.405 GHz to 2.470 GHz. Following the 802.15.4 standard, these frequencies are aliased as channels 11 through 26. For all newly manufactured nodes, the default setting is 2.425 GHz (channel 15).

FCC ID: XJQMSLINK0005

IC ID: 8505A-MSLINK0005

G-Link-200

This device complies with Part 15 of the United States FCC Rules, and Industry Canada's license-exempt RSSs. Operation is subject to the following two conditions: 1) This device may not cause interference, and 2) This device must accept any interference, including interference that may cause undesired operation of the device. Changes or modifications, including antenna changes not expressly approved by LORD Corporation could void the user's authority to operate the equipment.

Cet appareil est conforme à la Partie 15 des Règles de la FCC des États-Unis et aux RSSS exempts de licence d'Industrie Canada. Le fonctionnement est soumis aux deux conditions suivantes: 1) Cet appareil ne doit pas causer d'interférences et 2) Cet appareil doit accepter toute interférence, y compris les interférences pouvant entraîner un fonctionnement indésirable de l'appareil. Les changements ou modifications, y compris les changements d'antenne non expressément approuvés par LORD Corporation, pourraient annuler l'autorisation de l'utilisateur d'utiliser l'équipement.

11.6 Frequency Setting

NOTE

- The gateway can automatically manage nodes operating on different frequencies by using the Node Discovery feature in . In this routine, the gateway listens for node broadcasts on the frequency channel to which it is set. If the node is in normal boot-up mode, it will provide the broadcast when it is initially powered-on, and it will broadcast on all channels. As long as the node is powered-on after activating the Node Discovery feature, the gateway will link to it and remember the channel setting

for future node queries.

- Manually matching the node and gateway frequency channels is required in some applications. For example, when sending broadcast messages from the gateway to multiple nodes (including the synchronized sampling beacon) all nodes must be on the same channel as the gateway in order to receive the broadcast. Assigning channels is also a good idea when multiple gateways are attached to one host computer or when other wireless equipment is nearby and frequency or transmission interference may occur.

12. References

12.1 Technical Support

There are many resources for product support found on the LORD Sensing website, including technical notes, FAQs, and product manuals.

<http://www.microstrain.com/support/documentation>

For further assistance our technical support engineers are available to help with technical and applications questions.

Technical Support

sensing_support@LORD.com

Phone: 802-862-6629

Fax: 802-863-4093

SKYPE: microstrain.wireless.support

Live Chat is available from the website during business hours:
9:00 AM to 5:00 PM (Eastern Time US & Canada)

12.2 Product Ordering

Products can be ordered directly from the LORD Sensing website by navigating to the product page and using the Buy feature.

<http://www.microstrain.com/wireless>

For further assistance, our sales team is available to help with product selection, ordering options, and questions.

Sales Support

sensing_sales@LORD.com

Phone: 802-862-6629

Fax: 802-863-4093

9:00 AM to 5:00 PM (Eastern Time US & Canada)

12.3 Related Documents

Many references are available on the LORD Sensing website including product user manuals, technical notes, and quick start guides. These documents are continuously updated, and new applications are added. They may provide more accurate information than printed or file copies.

Document	Where to find it
Online Wireless Network Calculator	http://sensorcloud.com/?onlyCalc=true
SensorCloud Overview	http://www.sensorcloud.com/
SensorCloud Pricing	http://sensorcloud.com/pricing
MathEngine [®] Overview	http://www.sensorcloud.com/mathengine
SensorConnect Overview & Download	http://www.microstrain.com/software/sensorconnect
LORD Sensing Wireless Sensors Network Software Development Kit	https://github.com/LORD-MicroStrain/SensorCloud
Product Datasheets	http://www.microstrain.com/wireless/sensors
Product Manuals and Technical Notes	http://www.microstrain.com/support/documentation
Product Application Notes	http://www.microstrain.com/applications
NIST Calibration Procedures	http://www.nist.gov/calibrations/
ASTM Testing Procedures	http://www.astm.org/Standard/standards-and-publications.html

Table 9 - Related Documents

These terms are in common use throughout the manual:

A/D Value: the digital representation of the analog voltages in an analog-to-digital (A/D) conversion. The accuracy of the conversion is dependent on the resolution of the system electronics; higher resolution produces a more accurate conversion. Also referred to as "bits".

Base Station: The base station is the transceiver that attaches to the host computer and provides communication between the software and the node(s). It is also referred to as a gateway.

Burst Sampling: a mode of operation in which the node is sampled for a fixed window of time (burst) and then repeats that window at set intervals. The burst duration and time between bursts is configurable. Also referred to as periodic burst sampling.

Calibration: to standardize a measurement by determining the deviation standard and applying a correction (or calibration) factor

Configuration: a general term applied to the node indicating how it is set up for data acquisition. It includes settings such as sampling mode/rate, number of active channels, channel measurement settings, offsets, hardware gain, and calibration values.

Continuous Sampling: a mode of operation in which the node is sampled continuously until stopped or sampled continuously for a fixed amount of time

Coordinated Universal Time (UTC): the primary time standard for world clocks and time. It is similar to Greenwich Mean Time (GMT).

Cycle Power: a command transmitted to the node to reboot it either through a hardware or software switch

Data Acquisition: the process of collecting data from sensors and other devices

Data Logging: the process of saving acquired data to the system memory, either locally on the node or remotely on the host computer

DHCP (network): Dynamic Host Configuration Protocol is the standardized networking protocol used on Internet Protocol (IP) networks, which automatically configures devices that are attached to it by assigning and configuring the device IP address.

EMI: Electromagnetic Interference is an inductive or radiated disturbance that can create signal degradation on electrical signals, including loss of data.

ESD: Electrostatic Discharge is the sudden flow of electricity that can occur between two charged objects of different potential that come in contact or in close proximity of each other. Static electricity is a common source of ESD.

Event-Based Sampling: a mode of operation in which the node sampling is started when a sensor measurement value (threshold) is achieved

Firmware: the code that is programmed onto a microcontroller or similar device in an embedded system. It includes device operation commands, conditions, memory allocation, and many other tasks.

Gateway: The gateway is a transceiver that attaches to the host computer and provides communication between the software and the node(s). It is also known as a base station.

Host (computer): The host computer is the computer that orchestrates command and control of the attached devices or networks.

LED: Light Emitting Diode is an indicator light that is used in electronic equipment.

LOS (Line of Sight): is used in radio communications to describe the ideal condition between transmitting and receiving antennas in a radio network. As stated it means the antennae are in view of each other with no obstructions.

LXRS: Lossless Extended Range Synchronized is the proprietary LORD Sensing data communications protocol used in the wireless sensor network.

Node: The node is the wireless transceiver to which the sensor (s) is connected, providing communication with the gateway. The G-Link[®]-LXRS[®], V-Link[®]-LXRS[®], and SG-Link[®]-LXRS[®] are examples of nodes manufactured by LORD MicroStrain[®].

Node Tester Board: The node tester board is a device designed by LORD MicroStrain[®] that can be plugged into nodes to test their functionality.

Offset: When describing a mathematically-linear relationship, the offset is the value where the line that represents the relationship in a graph crosses the y -axis. The equation of a straight line is: $y = mx + b$, where x is the x -axis coordinate, y is the y -axis coordinate, m is the slope and b is the offset.

Oversampling: In signal processing, oversampling is a technique used to achieve increased signal resolution and better noise immunity by recording readings at a higher frequency than the output of the device being measured. In analog-to-digital conversion, the higher the oversampling rate, the better the recreated analog signal.

Packet: unit of sampled data

Periodic Burst Sampling: a mode of operation in which the node is sampled for a fixed window of time (burst) and then repeats that window at set intervals. The burst duration and time between bursts is configurable. Also referred to as burst sampling.

Ping: a byte transmitted by the gateway to the node. The node responds by echoing the byte, indicating communication exists between the node and gateway.

Range Test: a continuous string of pings used to validate communication between the gateway and the node over distance and obstruction

Real Time Clock (RTC): a computer clock that keeps track of the current time

RFI: Radio Frequency Interference is a disturbance in an electrical circuit due to electromagnetic induction or radiation.

RSSI: Received Signal Strength Indication is a measurement of the transmission power in a radio signal. It is measured in decibels with reference to 1 milliWatt (dBm).

RS232: a serial data communications protocol

Sensor: a device that physically or chemically reacts to environmental forces and conditions, producing a predictable electrical signal

Sleep: a command transmitted to the node to put it into sleep configuration

Sampling: the process of taking measurements from a sensor or device

Sampling Mode: the type of sampling that is being utilized, such as event-triggered, continuous, or periodic. The nodes have several sampling modes that employ these types of sampling.

Sampling Rate: the frequency of sampling

Slope: When describing a mathematically linear relationship, the slope is the steepness of the line that represents that relationship on a graph. The equation of a straight line is: $y = mx + b$, where x is the x-axis coordinate, y is the y-axis coordinate, m is the slope, and b is the offset.

Streaming: Streaming is a sampling mode in which all active channels (and the sensors attached to them) are measured, and the acquired data is transmitted to the gateway and software. The data is not written to non-volatile memory during streaming. Streaming can either be finite (have a user defined start and end time) or continuous (continued until the power is cycled on the node).

Synchronized Sampling: a sampling mode that automatically coordinates all incoming node data to a particular gateway. This mode is designed to ensure data arrival and sequence.

Transmission rate: the number of data packets per transmission window, measured in seconds. Depending on the sampling mode and settings it will be between 1 and 64 packets/second.

Transmission window: the time allowed for one data transmission at the automatically determined transmission rate

USB: Universal Serial Bus is a serial data communications protocol

WSN: Wireless Sensor Network describes a distribution of sensors and data acquisition equipment that autonomously monitors environmental characteristics, such as temperature, pressure, and strain.

14. Glossary

These terms are in common use throughout the manual:

A/D Value: the digital representation of the analog voltages in an analog-to-digital (A/D) conversion. The accuracy of the conversion is dependent on the resolution of the system electronics; higher resolution produces a more accurate conversion. Also referred to as "bits".

Base Station: The base station is the transceiver that attaches to the host computer and provides communication between the software and the node(s). It is also referred to as a gateway.

Burst Sampling: a mode of operation in which the node is sampled for a fixed window of time (burst) and then repeats that window at set intervals. The burst duration and time between bursts is configurable. Also referred to as periodic burst sampling.

Calibration: to standardize a measurement by determining the deviation standard and applying a correction (or calibration) factor

Configuration: a general term applied to the node indicating how it is set up for data acquisition. It includes settings such as sampling mode/rate, number of active channels, channel measurement settings, offsets, hardware gain, and calibration values.

Continuous Sampling: a mode of operation in which the node is sampled continuously until stopped or sampled continuously for a fixed amount of time

Coordinated Universal Time (UTC): the primary time standard for world clocks and time. It is similar to Greenwich Mean Time (GMT).

Cycle Power: a command transmitted to the node to reboot it either through a hardware or software switch

Data Acquisition: the process of collecting data from sensors and other devices

Data Logging: the process of saving acquired data to the system memory, either locally on the node or remotely on the host computer

DHCP (network): Dynamic Host Configuration Protocol is the standardized networking protocol used on Internet Protocol (IP) networks, which automatically configures devices that are attached to it by assigning and configuring the device IP address.

EMI: Electromagnetic Interference is an inductive or radiated disturbance that can create signal degradation on electrical signals, including loss of data.

ESD: Electrostatic Discharge is the sudden flow of electricity that can occur between two charged objects of different potential that come in contact or in close proximity of each other. Static electricity is a common source of ESD.

Event-Based Sampling: a mode of operation in which the node sampling is started when a sensor measurement value (threshold) is achieved

Firmware: the code that is programmed onto a microcontroller or similar device in an embedded system. It includes device operation commands, conditions, memory allocation, and many other tasks.

Gateway: The gateway is a transceiver that attaches to the host computer and provides communication between the software and the node(s). It is also known as a base station.

Host (computer): The host computer is the computer that orchestrates command and control of the attached devices or networks.

LED: Light Emitting Diode is an indicator light that is used in electronic equipment.

LOS (Line of Sight): is used in radio communications to describe the ideal condition between transmitting and receiving antennas in a radio network. As stated it means the antennae are in view of each other with no obstructions.

LXRS: Lossless Extended Range Synchronized is the proprietary LORD Sensing data communications protocol used in the wireless sensor network.

Node: The node is the wireless transceiver to which the sensor (s) is connected, providing communication with the gateway. The G-Link[®]-LXRS[®], V-Link[®]-LXRS[®], and SG-Link[®]-LXRS[®] are examples of nodes manufactured by LORD MicroStrain[®].

Node Tester Board: The node tester board is a device designed by LORD MicroStrain[®] that can be plugged into nodes to test their functionality.

Offset: When describing a mathematically-linear relationship, the offset is the value where the line that represents the relationship in a graph crosses the y -axis. The equation of a straight line is: $y = mx + b$, where x is the x -axis coordinate, y is the y -axis coordinate, m is the slope and b is the offset.

Oversampling: In signal processing, oversampling is a technique used to achieve increased signal resolution and better noise immunity by recording readings at a higher frequency than the output of the device being measured. In analog-to-digital conversion, the higher the oversampling rate, the better the recreated analog signal.

Packet: unit of sampled data

Periodic Burst Sampling: a mode of operation in which the node is sampled for a fixed window of time (burst) and then repeats that window at set intervals. The burst duration and time between bursts is configurable. Also referred to as burst sampling.

Ping: a byte transmitted by the gateway to the node. The node responds by echoing the byte, indicating communication exists between the node and gateway.

Range Test: a continuous string of pings used to validate communication between the gateway and the node over distance and obstruction

Real Time Clock (RTC): a computer clock that keeps track of the current time

RFI: Radio Frequency Interference is a disturbance in an electrical circuit due to electromagnetic induction or radiation.

RSSI: Received Signal Strength Indication is a measurement of the transmission power in a radio signal. It is measured in decibels with reference to 1 milliWatt (dBm).

RS232: a serial data communications protocol

Sensor: a device that physically or chemically reacts to environmental forces and conditions, producing a predictable electrical signal

Sleep: a command transmitted to the node to put it into sleep configuration

Sampling: the process of taking measurements from a sensor or device

Sampling Mode: the type of sampling that is being utilized, such as event-triggered, continuous, or periodic. The nodes have several sampling modes that employ these types of sampling.

Sampling Rate: the frequency of sampling

Slope: When describing a mathematically linear relationship, the slope is the steepness of the line that represents that relationship on a graph. The equation of a straight line is: $y = mx + b$, where x is the x-axis coordinate, y is the y-axis coordinate, m is the slope, and b is the offset.

Streaming: Streaming is a sampling mode in which all active channels (and the sensors attached to them) are measured, and the acquired data is transmitted to the gateway and software. The data is not written to non-volatile memory during streaming. Streaming can either be finite (have a user defined start and end time) or continuous (continued until the power is cycled on the node).

Synchronized Sampling: a sampling mode that automatically coordinates all incoming node data to a particular gateway. This mode is designed to ensure data arrival and sequence.

Transmission rate: the number of data packets per transmission window, measured in seconds. Depending on the sampling mode and settings it will be between 1 and 64 packets/second.

Transmission window: the time allowed for one data transmission at the automatically determined transmission rate

USB: Universal Serial Bus is a serial data communications protocol

WSN: Wireless Sensor Network describes a distribution of sensors and data acquisition equipment that autonomously monitors environmental characteristics, such as temperature, pressure, and strain.