

LORD QUICK START GUIDE

RTD-LINK[®]-200

Wireless 6 Channel Analog Input Sensor Node

The RTD-Link[®]-200 is a 6-channel wireless sensor used for the precise measurement of RTDs and thermistors. Calibration is not required. Select the desired thermocouple type and the node will output accurate, low-noise temperature, or resistance data.

Use this document to deploy the RTD-Link-200 for data collection. This includes electrical wiring, mounting the device, and using SensorConnect software to configure the node, start sampling, and display data.

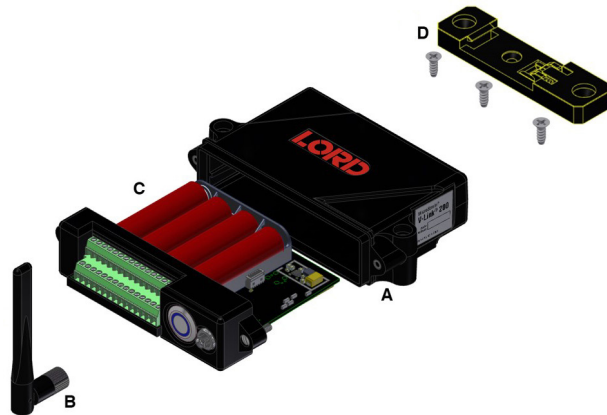

Figure 1. RTD-Link-200 Components

Item	Description	Quantity
A	TC-Link-200	1
B	Antenna with right angle adapter	1
C	AA Lithium batteries (3.6 V dc, 2.4 Ah)	4
D	DIN rail clip	1
	#6-32 x 3/8" Thread forming screws	3
E	35mm, M4 stainless steel mounting screws	2

Table 1. RTD-Link-200

Cycle power to the RTD-Link-200 using the “on/off” button. A quick push will power the device on or off. A longer push (approximately two seconds) will initiate sampling, indicated by the blue light illuminating. A very long push (approximately 10 seconds) will perform a hardware reset.

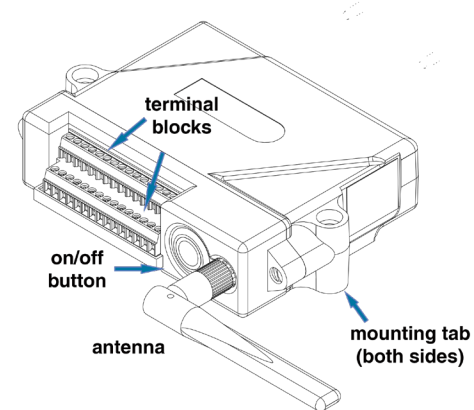

Figure 2. Interface and Indicators

Indicator	Behavior	Node Status
Device status indicator	OFF	Node is OFF
	Rapid green flashing on start-up	Node is booting up
	1 (slow) green pulse per second	Node is idle and waiting for a command
	1 green blink every 2 seconds	Node is sampling
	Blue LED during sampling	Node is resynchronizing
	Red LED	Built-in test error

Table 2. Indicator Behaviors

1. Pinout and Sensor Wiring

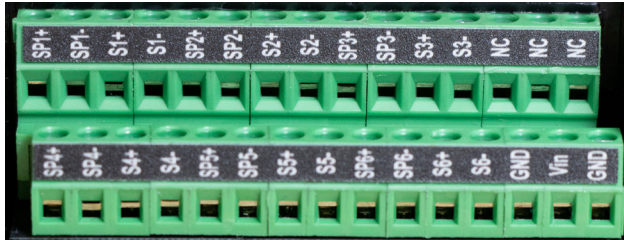

Figure 3. RTD-Link-200 Pinouts

Pin #	Signal	Pin #	Signal
1	SP1+	16	SP4+
2	SP1-	17	SP4-
3	S1+	18	S4+
4	S1-	19	S4-
5	SP2+	20	SP5-
6	SP2-	21	GND
7	S2+	22	S5+
8	S2-	23	S5-
9	SP3+	24	SP6+
10	SP3-	25	SP6-
11	S3+	26	S6+
12	S3-	27	S6-
13	NC	28	GND
14	NC	29	Vin
15	NC	30	GND

Table 3. RTD-Link-200 Pinout and Signal

Signal	Description	Pin Type	Range
VIN	External supply voltage	Power input	4.0 V to 36 V
GND	External supply ground	Power return	GND
SPx+	Sensor voltage supply. Power is duty cycled to sensors unless configured to power continuously.	Analog output	0 to 2.5 V
SPx-	Sensor ground	GND	GND
Sx+	Sensor input +	Analog input	0 to 2.5 V
Sx-	Sensor input -	Analog input	0 to 2.5 V

Table 4. RTD-Link-200 Connections

Resistance Thermometer (RTD)

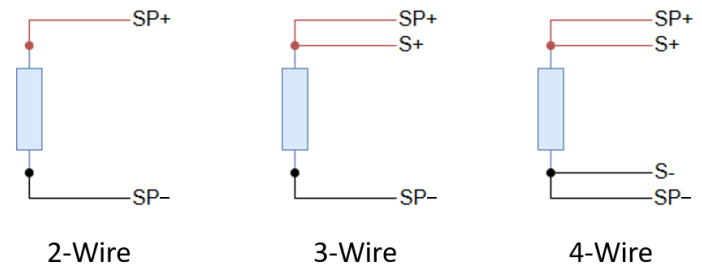

Thermistor

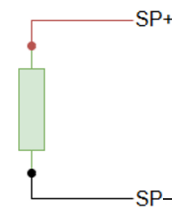

Figure 4. Thermocouple Wiring Options

2. Mounting Recommendations

There are 2 mounting holes on the RTD-Link-200 for use with the provided 35 mm, M4 stainless steel socket head screws (Figure 6). It is recommended that the node is mounted in a way that optimizes wireless communications.

Alternatively, install the provided DIN rail mounting clip for mounting to standard 35 mm DIN rail with rail depths of 7.5 mm or greater. The DIN rail option is not recommended for applications where the node is subject to high vibrations.

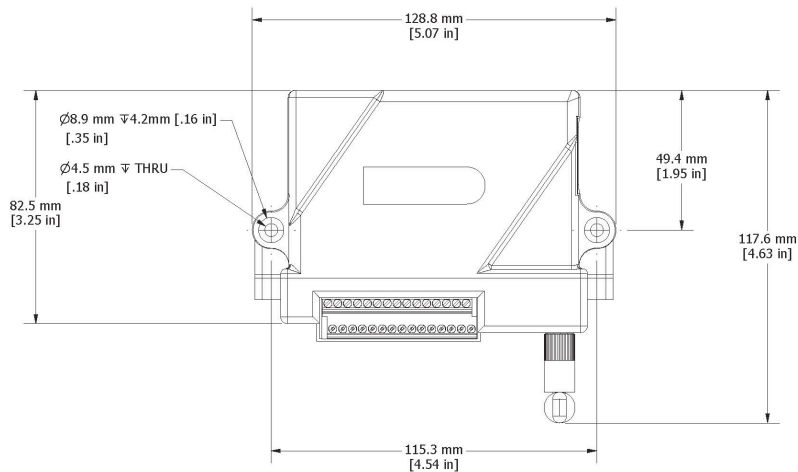

Figure 5. Mounting the Node

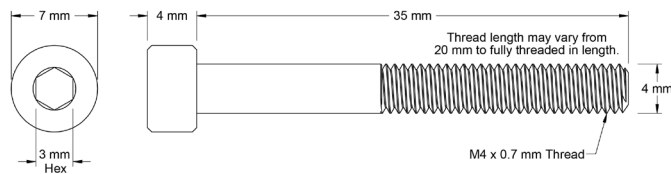

Figure 6. 35 mm M4 Stainless Steel Socket Head Screw

3. Node Operational Modes

Sensor nodes have three operational modes: active, sleep, and idle. When the node is sampling, it is in active mode. When sampling stops, the node switches into idle mode, which is used for configuring node settings and allows toggling between active and sleep mode. The node will automatically enter into the sleep mode after a user-determined period of inactivity. The node will not enter into sleep mode while sampling.

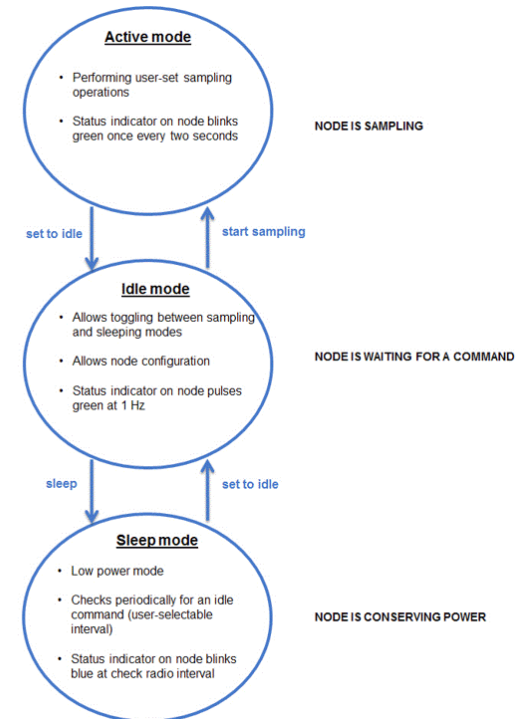

Figure 7. Node Operational Modes

4. Install Software

Install the SensorConnect software on the host computer before connecting hardware. Access the free software download on the LORD Sensing website.



<http://www.microstrain.com/software>

5. Establish Gateway Communication

Drivers for the USB gateways are included in the SensorConnect software installation. With the software installed, the USB gateway will detect automatically whenever the gateway is plugged in.

1. Power is applied to the gateway through the USB connection. Verify the gateway status indicator is illuminated, showing the gateway is connected and powered on.
2. Open the SensorConnect™ software.

The gateway should appear in the Controller window with a communication port assignment. If the gateway is not discovered, verify the port is active on the host computer, then remove and re-insert the USB connector.

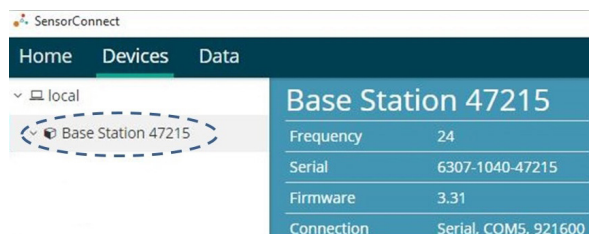

Figure 8. USB Gateway Communication

6. Connect to Nodes

Several methods can be used in SensorConnect to establish communication with the nodes: the automatic node discovery on the same frequency, automatic node discovery on a different frequency, and add node manually.

A. Automatic Node Discovery on Same Frequency

If the base and node are on the same operating frequency, the node will populate below the Base Station listing when powering on the RTD-Link-200.

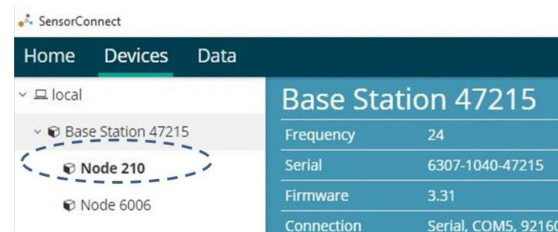

Figure 9. Node Discovered On Same Frequency

B. Automatic Node Discovery on Different Frequency

If a red circle with a number appears next to the Base Station, the node may be operating on a separate radio channel. Select the Base Station and then select the Nodes on Other Frequencies tile.

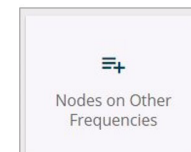
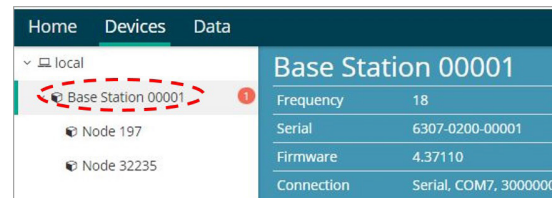

Figure 10. Node On Other Frequency

Highlight the new node being added and select Move Node to Frequency (#).

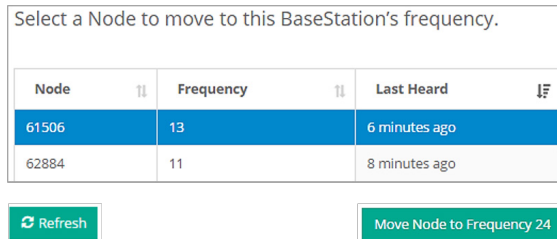

Figure 11. Move Node

C. Manually Add Node

Adding a node manually requires entering the node address and its current frequency setting.

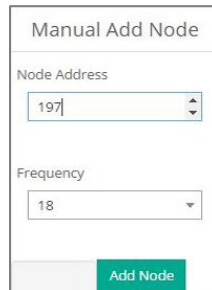

Figure 12. Add Node By Address

If the node was successfully added, two confirmation messages appear and it will be listed under the Base Station.

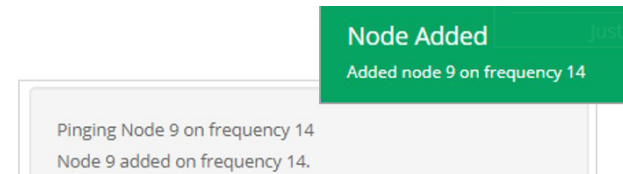

Figure 13. Node Added Confirmation

If the node fails to add, a failure message appears. The node did not respond to the base station which could indicate the node is not in idle mode or may be on another frequency. If “Add Node Anyway” is selected, it associates that node with the channel entered, but likely causes a communication error. If the node was not in idle, move the base station to the frequency of the node and issue a “Set to Idle” command.

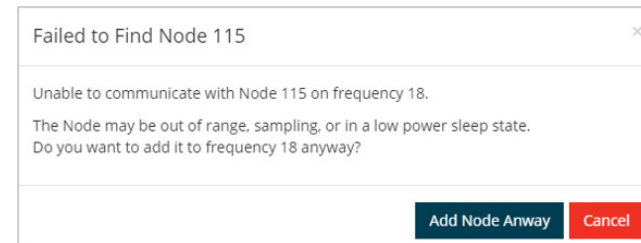

Figure 14. Failure to Add Node

7. Configure Node

NOTE: The following SensorConnect screens were created using a RTD-Link-200. Other Nodes will appear differently, but the menus and operations within SensorConnect remain the same.

Node settings are stored to non-volatile memory and are configured using SensorConnect. Select the Node under the Devices menu. Click on the Configure button under the Setup heading.

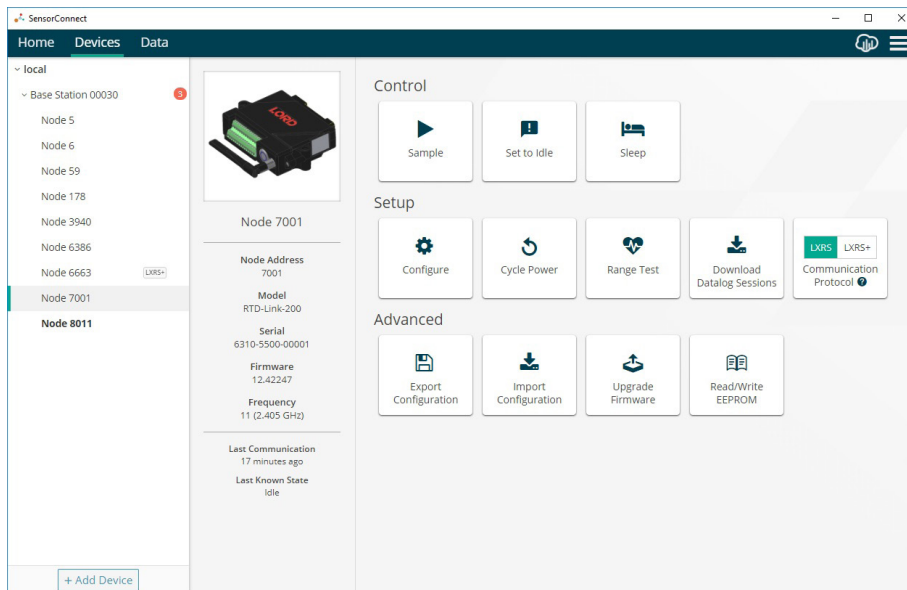

Figure 15. Node Configuration Menu

The Hardware menu tab displays the current node settings.

1. To change the default Temperature Sensor settings, use the dropdown menus found under Transducer Type, Sensor Type, and Wire Type.
2. To change the default Low Pass Filter settings, use the dropdown menu found under Filter Cutoff.
3. To change the default Input range settings, use the dropdown menus found under Input Range. This setting is used only when the Sensor Type is set to Uncompensated Resistance.
4. Select Apply Configuration to write to node memory.

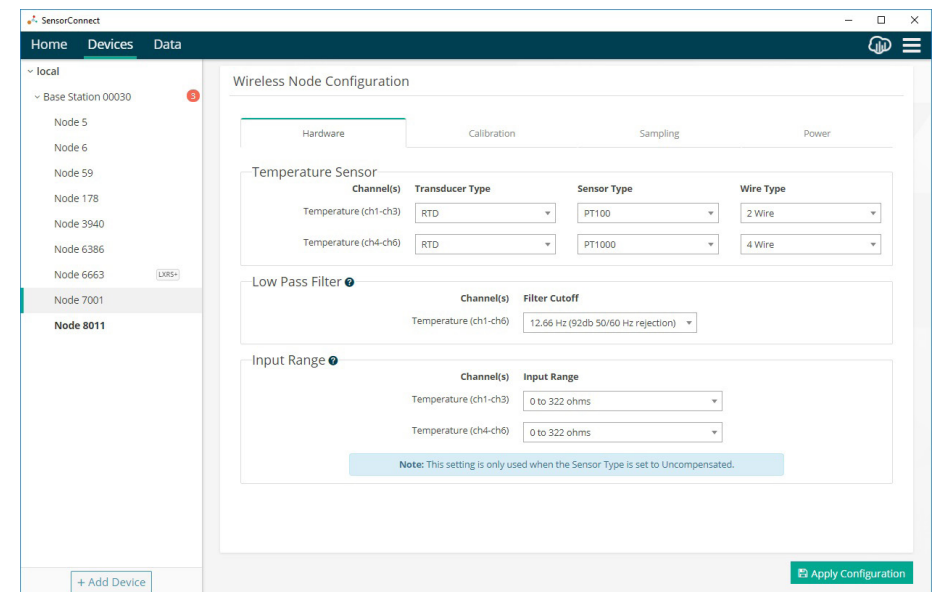

Figure 16. Hardware Configuration Tab

8. Configure Sampling Setting and Start Data Acquisition

1. Click the Base Station > Sample Network tile, and indicate the nodes to be sampled by checking the box to the left of each node in the list.

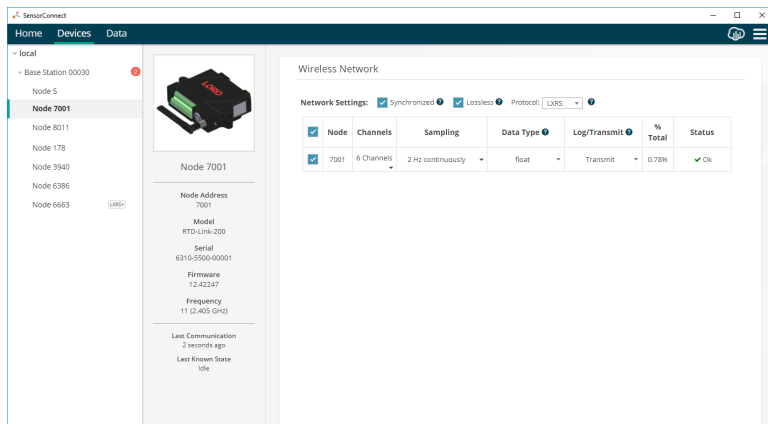

Figure 17. Select Node To be Sampled

2. Under the Sampling column, select Sample Rate from the drop down menu. Select Continuously to sample indefinitely.

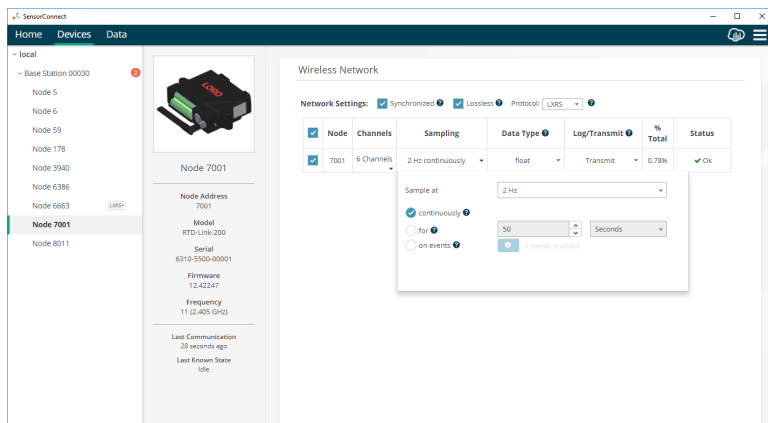

Figure 18. Sampling Setting

3. Select Apply and Start Network. A message indicates the Network Started and includes a shortcut link to the Data Tab.

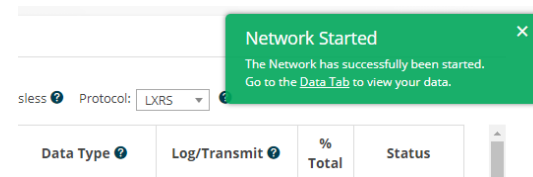

Figure 19. Network Started with shortcut to Data Tab

4. Navigate to the Data tab and view the Empty Dashboard 1. Click the +Add Widget button to add a Widget to Dashboard 1.

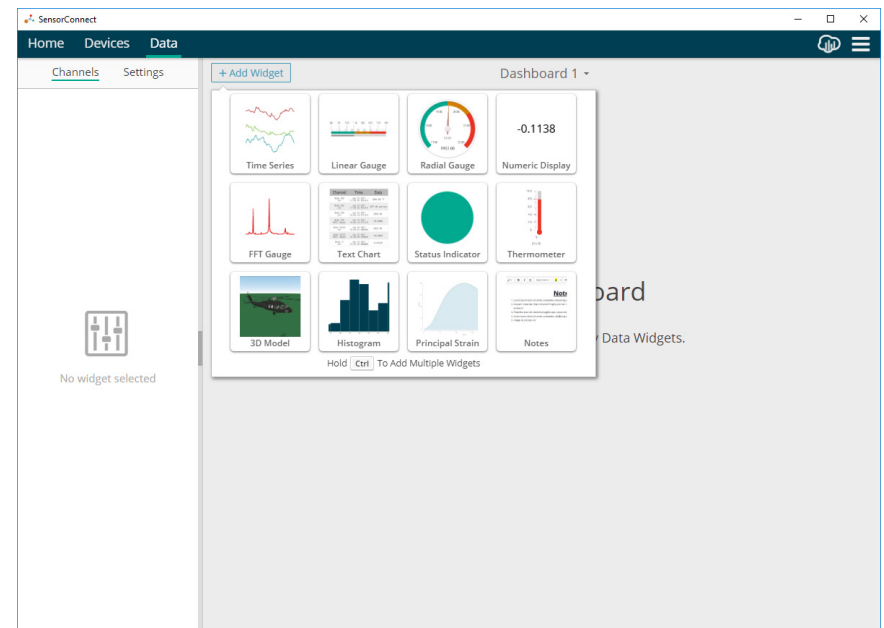

Figure 20. +Add Widget

5. Select the Time Series tile to add a Time Series graph to Dashboard 1. The Time Series Graph displays with “No channels selected”. View the available channels and options under the Node’s V Menu.

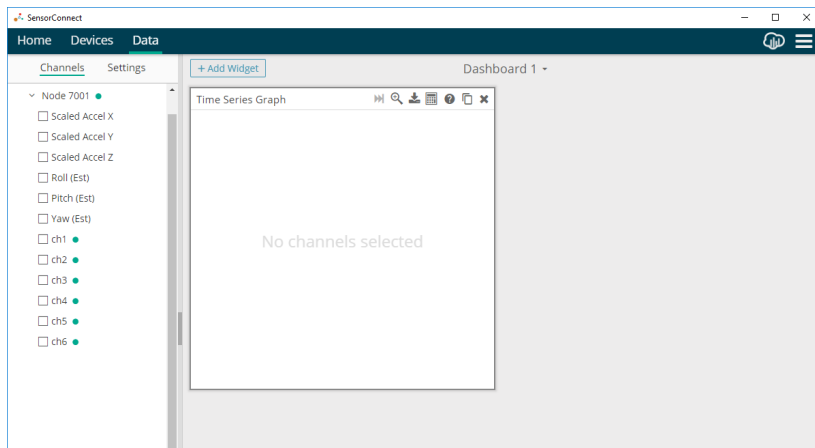

Figure 21. Add Time Series Graph Channel Selection

6. Select the desired channels and options to begin data collection.

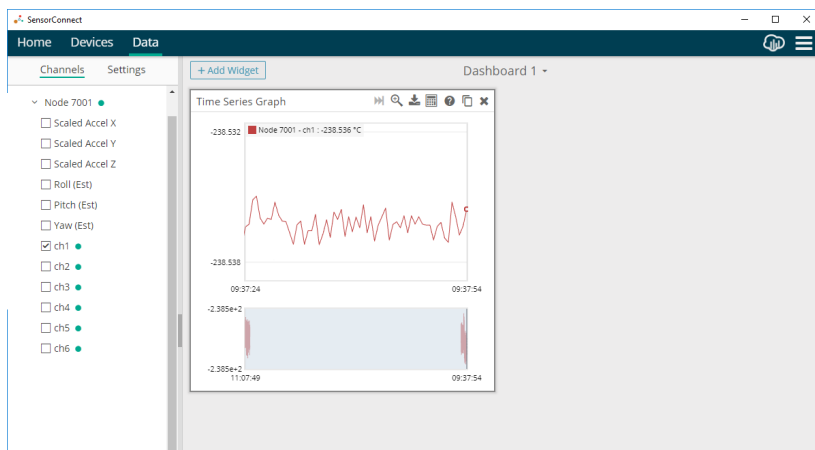

Figure 22. Time Series Graph with Channel 1 Selected

9. Replacing Batteries

1. Remove the screws on both sides of the face plate.
2. Replace all four batteries. The positive polarities are indicated on the batteries and the node by a “+” symbol.
3. Reassemble.

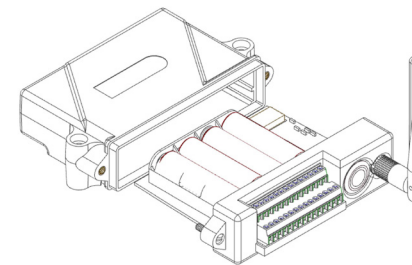

Figure 23. Replace Batteries

10. Battery Hazards



WARNING



CAUTION

NOTICE

The RTD-Link-200 contains internal, non-rechargeable lithium batteries. Lithium batteries are a fire and explosion hazard. Do not store or operate the node at temperatures above 212°F (100°C). Do not disassemble, short circuit, crush, puncture, or otherwise misuse the battery.

Lithium batteries contain toxic chemicals that are harmful to humans and the environment. Disposal is subject to federal and local laws. Do not discard the battery or the node in the trash. Follow proper battery disposal protocol, or contact LORD Sensing Technical Support for information on extracting the battery or returning the product for proper recycling and disposal.

11. Power Supply



WARNING



CAUTION

NOTICE

Apply only the input voltage range specified for the RTD-Link-200. Connect to a power source that is near the device, is accessible, and adheres to all national wiring standards. Compliance with wiring standards is assumed in the installation of the power source and includes protection against excessive currents, short circuits, and ground faults. Failure to do so could result in personal injury and permanent damage to the device.

12. Radio Specifications

The RTD-Link-200 employs a 2.4GHz IEEE 802.15.4 compliant radio transceiver for wireless communication. The radio is a direct-sequence spread spectrum radio and can be configured to operate on 16 separate frequencies ranging from 2.405 GHz to 2.480 GHz. Following the 802.15.4 standard, these frequencies are aliased as channels 11 through 26. For all newly manufactured nodes, the default setting is 2.425 GHz (channel 15).

RTD-Link-200

FCC ID: XJQMSLINK0012

IC ID: 8505A-MSLINK0012

This device complies with Part 15 of the United States FCC Rules, and Industry Canada's license-exempt RSSs. Operation is subject to the following two conditions: 1) This device may not cause interference, and

2) This device must accept any interference, including interference that may cause undesired operation of the device. Changes or modifications, including antenna changes not expressly approved by LORD Corporation could void the user's authority to operate the equipment.

Cet appareil est conforme à la Partie 15 des Règles de la FCC des États-Unis et aux RSSS exempts de licence d'Industrie Canada. Le fonctionnement est soumis aux deux conditions suivantes: 1) Cet appareil ne doit pas causer d'interférences et 2) Cet appareil doit accepter toute interférence, y compris les interférences pouvant entraîner un fonctionnement indésirable de l'appareil. Les changements ou modifications, y compris les changements d'antenne non expressément approuvés par LORD Corporation, pourraient annuler l'autorisation de l'utilisateur d'utiliser l'équipement.